

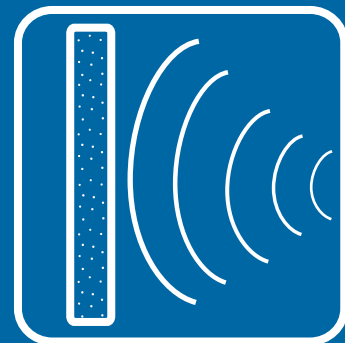

GYPSUM ASSOCIATION

# FIRE RESISTANCE DESIGN MANUAL SOUND CONTROL GYPSUM SYSTEMS

**19<sup>th</sup>**  
Edition  
GA-600-2009



# FOREWORD

The Gypsum Association *FIRE RESISTANCE DESIGN MANUAL* is referenced by the following code and standards writing organizations:

*INTERNATIONAL BUILDING CODE*, published by:

International Code Council, Inc.  
5203 Leesburg Pike, Suite 600  
Falls Church, Virginia 22041

(See footnote a, Tables 719.1a, 719.1b, and 719.1c)

*BOCA NATIONAL BUILDING CODE*, published by:

Building Officials and Code Administrators International, Inc.  
4051 West Flossmoor Road  
Country Club Hills, Illinois 60478-5795

(See Chapters 7, 12, and 25, Commentary to the BOCA National Building Code)

*UNIFORM BUILDING CODE*, published by:

International Conference of Building Officials  
5360 Workman Mill Road  
Whittier, California 90601

(See footnote a, Tables No. 7-A, -B, and -C, and Appendix Section 1209)

*STANDARD BUILDING CODE*, published by:

Southern Building Code Congress International, Inc.  
900 Montclair Road  
Birmingham, Alabama 35213-1206

(See Section 701.5.2)

*THE NATIONAL FIRE CODES*, published by:

National Fire Protection Association  
1 Batterymarch Park  
P.O. Box 9101  
Quincy, Massachusetts 02269-9101

(See NFPA 90A, NFPA 101, NFPA 221, NFPA 5000, and the Life Safety Code Handbook)

The *FIRE RESISTANCE DESIGN MANUAL* is also referenced in the code documents of major jurisdictions in the United States such as Florida, Chicago, Los Angeles, and New York City. In addition, the Manual has been recognized in major jurisdictions in Canada.

# TABLE OF CONTENTS

<b>FOREWORD</b> .....	3
<b>TABLE OF CONTENTS</b> .....	4
<b>INTRODUCTION</b> .....	6
<b>SECTION I - USE OF THIS MANUAL AND GENERAL EXPLANATORY NOTES</b> .....	7
Overview .....	7
Description of Terms .....	7
General Explanatory Notes .....	8
Testing Agencies .....	10
Product Identification .....	11
Abbreviations .....	11
<b>SECTION II - REQUIREMENTS FOR FIRE PROTECTION</b> .....	12
Fire Resistive Properties of Gypsum .....	12
Type X Gypsum Board .....	12
Performance of Gypsum Plaster .....	12
Fire Resistance Tests .....	13
Wall and Partition Systems .....	13
Area Separation Fire Walls (Party/Fire Walls) .....	14
Floor-Ceiling and Roof-Ceiling Systems .....	14
Ceiling Openings .....	14
Beam, Girder, and Truss Protection Systems .....	15
Continuous Ceiling Protection .....	15
Individual Encasement Protection .....	15
Column Protection Systems .....	16
Fire Blocking .....	17
Smoke Barriers .....	17
Perimeter Relief and Control Joints .....	17
Surface Burning Characteristics .....	18
<b>SECTION III - SOUND CONTROL</b> .....	19
Sound Insulation .....	19
Sound Transmission Loss Tests .....	21
Impact Noise Test .....	22
Notes .....	23
<b>SECTION IV - FIRE RESISTANCE AND SOUND CONTROL SYSTEMS</b> .....	24
<b>INDEX TO SYSTEMS BY STC RATING</b> .....	24
<b>LISTING OF DELETED SYSTEMS</b> .....	26
<b>LISTING OF NEW SYSTEMS</b> .....	26
<b>WALL AND PARTITION SYSTEMS</b> .....	27
Walls and Interior Partitions, Noncombustible, 1 HOUR .....	27
Walls and Interior Partitions, Noncombustible, 2 HOUR .....	42
Walls and Interior Partitions, Noncombustible, 3 HOUR .....	55
Walls and Interior Partitions, Noncombustible, 4 HOUR .....	57
Walls and Interior Partitions, Wood Framed, 1 HOUR .....	60
Walls and Interior Partitions, Wood Framed, 2 HOUR .....	71
Chase Walls, Noncombustible, 1 HOUR .....	74
Chase Walls, Noncombustible, 2 HOUR .....	75
Chase Walls, Wood Framed, 1 HOUR .....	78
Chase Walls, Wood Framed, 2 HOUR .....	79
Movable and Office Partitions, 1 HOUR .....	80
Movable and Office Partitions, 2 HOUR .....	83
Shaft Walls, 1 HOUR .....	84
Shaft Walls, 2 HOUR .....	86
Shaft Walls, 3 HOUR .....	100

## TABLE OF CONTENTS

Shaft Walls, 4 HOUR .....	102
Exterior Walls, 1 HOUR .....	103
Exterior Walls, 2 HOUR .....	108
Metal Clad Exterior Walls, 1 HOUR .....	112
Metal Clad Exterior Walls, 2 HOUR .....	113
Area Separation Fire Walls (Party/Fire Walls), 2 HOUR .....	115
Area Separation Fire Walls (Party/Fire Walls), 3 HOUR .....	121
<b>FLOOR-CEILING SYSTEMS</b> .....	<b>122</b>
Floor-Ceiling Systems, Noncombustible, 1 HOUR .....	122
Floor-Ceiling Systems, Noncombustible, 1½ HOUR .....	125
Floor-Ceiling Systems, Noncombustible, 2 HOUR .....	125
Floor-Ceiling Systems, Noncombustible, 3 HOUR .....	130
Floor-Ceiling Systems, Noncombustible, 4 HOUR .....	130
Floor-Ceiling Systems, Steel Framed, Wood Floor, 1 HOUR .....	131
Floor-Ceiling Systems, Steel Framed, Wood Floor, 2 HOUR .....	133
Floor-Ceiling Systems, Wood Framed, 1 HOUR .....	134
Floor-Ceiling Systems, Wood Framed, 1½ HOUR .....	149
Floor-Ceiling Systems, Wood Framed, 1¾ HOUR .....	150
Floor-Ceiling Systems, Wood Framed, 2 HOUR .....	150
<b>ROOF-CEILING SYSTEMS</b> .....	<b>153</b>
Roof-Ceiling Systems, 1 HOUR .....	153
Roof-Ceiling Systems, 2 HOUR .....	156
<b>COLUMN PROTECTION SYSTEMS</b> .....	<b>158</b>
Columns, Noncombustible, 1 HOUR .....	158
Columns, Noncombustible, 2 HOUR .....	161
Columns, Noncombustible, 3 HOUR .....	168
Columns, Noncombustible, 4 HOUR .....	173
<b>BEAM, GIRDER, AND TRUSS PROTECTION SYSTEMS</b> .....	<b>175</b>
Beams, Girders, and Trusses, Noncombustible, 1 HOUR .....	175
Beams, Girders, and Trusses, Noncombustible, 2 HOUR .....	175
Beams, Girders, and Trusses, Noncombustible, 3 HOUR .....	176
Beams, Girders, and Trusses, Noncombustible, 4 HOUR .....	177
<b>APPENDIX</b> .....	<b>178</b>
Commonly Used Metric Conversions .....	178

## INTRODUCTION

NOTE: This Introduction constitutes an essential part of the system descriptions contained in Section IV. It is important that the user be familiar with this introductory material.

This Manual is a convenient and useful specification aid for anyone concerned with the design, construction, or inspection of fire resistive and sound control systems. Design information is quickly and easily determined. Comparison of these characteristics allows the user to be more accurate in meeting design and code requirements. The data provided are especially useful to builders, architects, code officials, fire service, and insurance personnel.

When differences occur between provisions of this Manual and the appropriate building code or regulation, including provisions of other standards referenced in the code or regulation, the most stringent provision shall apply.

The systems in this Manual utilize gypsum products to provide fire resistance to walls, partitions, floor-ceilings, roof-ceilings, columns, beams, girders, and trusses. Systems are classified according to their typical uses and their fire-resistance ratings. Walls, partitions, and floor-ceiling systems are further classified by Sound Transmission Class (STC) or Field Sound Transmission Class (FSTC). The Impact Insulation Class (IIC) is included for many wood framed floor-ceiling systems.

WHERE THE WORD "PROPRIETARY" APPEARS IN SYSTEM DESCRIPTIONS EITHER THE SYSTEM OR ONE OR MORE OF ITS COMPONENTS IS CONSIDERED PROPRIETARY. EACH PROPRIETARY SYSTEM SHALL BE BUILT UTILIZING THE COMPONENTS SPECIFIED BY THE COMPANY OR COMPANIES LISTED UNDER THE DETAILED DESCRIPTION FOR THAT SYSTEM. ALL OTHER SYSTEMS ARE GENERIC. GENERIC SYSTEMS ARE APPLICABLE TO THE PRODUCTS OF ANY MANUFACTURER, WHETHER A MEMBER OF THE GYPSUM ASSOCIATION OR NOT, PROVIDED THE PRODUCTS MEET THE APPROPRIATE STANDARDS LISTED IN SECTION I AND, WHEN APPLICABLE, THE REQUIREMENTS SET FORTH IN SECTION II.

To maintain industry-wide quality assurance standards for gypsum board defined in this Manual as "type X," the Gypsum Association requires that all companies listing proprietary tests or systems, or relying on the generic systems in this manual, shall subscribe to an on-going third-party, in-plant product inspection and labeling service. Additionally, each member company makes annual written certification to the Gypsum Association that its products manufactured for use in systems listed in this Manual continue to be inspected and labeled by an independent third-party testing service as listed on page 10.

Fire-resistance ratings, STCs, FSTCs, and IICs are the results of tests conducted on systems composed of specific materials put together in a specified manner.

Substitution of other materials or deviation from the specified construction could adversely affect performance. For example, if batt or blanket insulation is shown, then it is a required component of the system. In each system containing batt or blanket insulation the insulation is specified to be either mineral or glass fiber and, for fire resistance, the system shall be constructed using the type specified.

*Mineral fiber or glass fiber shall not be arbitrarily added to floor-ceiling or roof-ceiling systems to increase either STCs or R-values. This practice has been shown to reduce the fire-resistance rating.* The addition of up to 16<sup>3</sup>/<sub>4</sub> inches of 0.5 pcf glass fiber insulation (R-40), either batt or loose-fill, to any 1- or 2-hour fire resistance rated floor-ceiling or roof-ceiling system having a cavity deep enough to accept the insulation is permitted provided that one additional layer of either 1/2 inch or 5/8 inch type X gypsum board is applied to the ceiling. The additional layer of gypsum board shall be applied as described for the face layer of the tested system except that the fastener length shall be increased by not less than the thickness of the additional layer of gypsum board.

The detailed descriptions for the systems included in this Manual are summaries. For complete information on the systems or components tested, the listing or test report should be reviewed. Details regarding generic systems may be requested from the Gypsum Association; details on proprietary systems are available from the companies listed for those systems.

For information on limiting heights of nonload-bearing steel stud walls and partitions see ASTM C 754, *Standard Specification for Installation of Steel Framing Members to Receive Screw Attached Gypsum Panel Products*, or steel stud manufacturer's literature.

References to ASTM standards, CAN/ULC standards, or other standards refer to the respective standard in effect on the date that the test was performed. Each test reference contains the test report date.

The information in this Manual is based on characteristics, properties, and performance of materials and systems obtained under controlled test conditions as set forth in the appropriate standards in effect at the time of the test. The Gypsum Association and its member companies make no warranties or other representations as to the characteristics, properties, or performance of any materials or systems in actual construction. No warranty or representation is made that any material or component of any system, other than the gypsum material used in such system, conforms to any standard or standards.

## SECTION I - USE OF THIS MANUAL AND GENERAL EXPLANATORY NOTES

### OVERVIEW

The systems are divided into five major categories and listed in the Table of Contents on pages 4 and 5 under these headings:

- Wall and Partition Systems
- Floor-Ceiling Systems
- Roof-Ceiling Systems
- Column Protection Systems
- Beam, Girder, and Truss Protection Systems

In the case of walls and partitions, floor-ceilings, and roof-ceilings, noncombustible systems are listed first, followed by wood-framed systems. They are further subdivided by fire-resistance rating starting with one hour and increasing. STCs (or FSTCs) are listed in descending order. *Where sound test data are not available, estimated STCs are based on evaluations of similar systems for which test data are available.*

Each system has been assigned a reference number - the GA File Number. *Cite this GA File Number in specifications and on plans, or when making inquiries about specific systems.*

All system descriptions contain a brief list of the major components of the system followed by a more detailed description. The detailed descriptions of interior systems begin with the material exposed to the test fire and its method of attachment, followed by a description of the framing members and their methods of installation. Finally, the unexposed side and its method of attachment is described.

Where unsymmetrical systems were tested from one side only, the side exposed to the test fire is indicated by the words "Fire Side" on the system detail. When documentation is available to show that the wall was tested with the least fire-resistive side exposed to the test fire, the wall need not be subjected to tests from the opposite side and a "Fire Side" is not specified. All floor-ceiling and roof-ceiling systems were tested with fire exposure on the ceiling side.

When mineral or glass fiber insulation was a basic component of a fire tested system, it is included in the description as an integral part of the system. The insulation thickness, type, and density are described, and both the fire and sound details show fibrous insulation. If the insulation was used solely to increase the STC, the fibrous insulation is shown only in the sound detail. *When the insulation is not needed for the fire-resistance rating, but is used to improve the STC of the system, the last sentence of the detailed description*

NOTE: Listing of a system in a specific category in this Manual is not intended to limit its use to that category (see General Explanatory Note 13 on page 8). However, this shall not be interpreted to imply that vertical systems, such as walls and partitions, are permitted to arbitrarily be used in a horizontal orientation. In addition, the manufacturer shall be consulted for other products which satisfy the fire and sound requirements shown for the systems.

*states, "Sound tested with [mineral] [glass] fiber insulation." (See General Explanatory Notes 10, 11, and 12 on page 8.)*

Unless indicated otherwise, all load-bearing wood stud systems were tested while being subjected to the maximum load allowed by design under nationally recognized design criteria at the time of the test. Due to an increase in the maximum allowable loading in the *National Design Specifications* (1982 and later editions), the American Forest and Paper Association issued the following statement:

Where a load-bearing fire rated wood stud wall assembly contained in this Manual is specifically designed for structural capacity, the design value in compression parallel to grain adjusted for slenderness ratio ( $F_c'$ ) used in such analysis shall be taken as 78 percent of the maximum  $F_c'$  value determined in accordance with normal design practice but shall not exceed 78 percent of the  $F_c'$  value for such member having a slenderness ratio ( $l_e/d$ ) of 33.

### DESCRIPTION OF TERMS USED IN THIS MANUAL

**Gypsum Board** - defined in ASTM C 11, *Standard Terminology Relating to Gypsum and Related Building Materials and Systems*, as "the generic name for a family of sheet products consisting of a noncombustible core primarily of gypsum with paper surfacing." Gypsum board may be further described as follows:

**Regular Gypsum Board** - a gypsum board with naturally occurring fire resistance from the gypsum in the core; or

**Type X Gypsum Board** - a gypsum board with special core additives to increase the natural fire resistance of regular gypsum board.

**Limited Load-Bearing** - this means that a constant superimposed load was applied to the test specimen throughout the fire test to simulate a design load less than 78% of the maximum allowable design load.

**Load-Bearing** - unless otherwise noted in the detailed description, this means that a constant superimposed load was applied to the test specimen throughout the fire test to simulate 78% or more of the maximum allowable design load.

**Mineral Fiber** - refers to either rock or slag wool products.

**Metal Studs** - refers to steel studs and runners (track) not less than 0.0179 in. base metal thickness and manufactured to comply with ASTM C 645 unless otherwise specified in the detailed description.

**(NLB)** - nonload-bearing.

NOTE: Where the word "proprietary" appears in system descriptions either the system or one or more of its components is considered proprietary. Each proprietary system shall be built utilizing the components specified by the company or companies listed under the detailed description for that system.

## GENERAL EXPLANATORY NOTES

1. All dimensions, weights, temperatures, and pressures are in U.S. customary units. For commonly used metric (SI) conversions refer to the Appendix on page 155 and IEEE/ASTM S 10-2002, *Standard for Use of the International System of Units (SI): The Modernized Metric System*.
  2. Nails shall comply with ASTM F 547 or ASTM C 514. Other nails, suitable for the intended use, and having dimensions not less than those specified in this Manual shall be permitted as substitutions.
  3. Fasteners installed along the edges of gypsum board shall be placed along the paper bound edges on the long dimension of the board. Fasteners at the end shall be placed along mill or field cut ends on the short dimension. Fasteners on the perimeter of the board shall be placed along both edges and ends. Indicated fastener spacings are maximums.
  4. Screws meeting ASTM C 1002 shall be permitted to be substituted for the prescribed nails, one for one, when the length and head diameter of the screws equal or exceed those of the nails specified in the tested system and the screw spacing does not exceed the spacing specified for the nails in the tested system.
  5. Vertically applied gypsum board shall have the edges parallel to framing members. Horizontally applied gypsum board shall have the edges at right angles to the framing members. Intermediate vertical framing members are those between the vertical edges or ends of the board.
  6. Unless otherwise specified, the face layers of all systems, except those with predecorated or metal covered surfaces, shall have joints taped (minimum Level 1 as specified in GA-214, *Recommended Levels of Gypsum Board Finish*) and fastener heads treated. Base layers in multi-layer systems shall not be required to have joints or fasteners taped or covered with joint compound.
  7. When a fire-resistance rated partition extends above the ceiling, the gypsum board joints occurring above the ceiling need not be taped and fasteners need not be covered when all of the following conditions are met.
    - a. The ceiling is part of a fire-resistance rated floor-ceiling or roof-ceiling system;
    - b. All vertical joints occur over framing members;
    - c. Horizontal joints are either staggered 24 inches o.c. on opposite sides of the partition, or are covered with strips of gypsum board not less than 6 inches wide; or the partition is a two-layer system with joints staggered 16 inches or 24 inches o.c.; and
    - d. The partition is not part of a smoke or sound control system.
- Where joint treatment is discontinued at or just above the ceiling line, the vertical joint shall be cross taped at this location to reduce the possibility of joint cracking.
8. Metallic outlet boxes shall be permitted to be installed in wood and steel stud walls or partitions having gypsum board facings and classified as two hours or less. The surface area of individual boxes shall not exceed 16 square inches. The aggregate surface area of the boxes shall not exceed 100 square inches in any 100 square feet. Boxes located on opposite sides of walls or partitions shall be in separate stud cavities and shall be separated by a minimum horizontal distance of 24 inches. Approved nonmetallic outlet boxes shall be permitted as allowed by local code.
  9. Water-resistant gypsum backing board shall be installed over or as part of the fire-resistance rated system in areas to receive ceramic or plastic wall tile or plastic finished wall panels. When fire or sound ratings are necessary, the gypsum board required for the rating shall extend down to the floor behind fixtures so that the construction will equal that of the tested system.
 

Note: The use of water-resistant gypsum backing board as a base for tile in wet areas is regulated by local codes. Consult local building codes for requirements.
  10. When not specified as a component of a fire tested wall or partition system, mineral fiber, glass fiber, or cellulose fiber insulation of a thickness not exceeding that of the stud depth shall be permitted to be added within the stud cavity.
  11. In floor-ceiling or roof-ceiling systems, the addition or deletion of mineral or glass fiber insulation in ceiling joist spaces could possibly reduce the fire-resistance rating. The addition of up to 16<sup>3</sup>/<sub>4</sub> inches of 0.5 pcf glass fiber insulation (R-40), either batt or loose-fill, to any 1- or 2-hour fire resistance rated floor-ceiling or roof-ceiling system having a cavity deep enough to accept the insulation is permitted provided that one additional layer of either 1/2 inch type X or 5/8 inch type X gypsum board is applied to the ceiling. The additional layer of gypsum board shall be applied as described for the face layer of the tested system except that the fastener length shall be increased by not less than the thickness of the additional layer of gypsum board.
  12. In each system containing batt or blanket insulation the insulation is specified to be either mineral or glass fiber and, for fire resistance, the system shall be built using the type specified.
  13. Although the systems are arranged in general groupings (i.e. walls and interior partitions, floor-ceilings, roof-ceilings, etc.), this is not intended to limit their use only to the specific category in which they are listed. For example, systems listed as shaft walls shall be permitted to be used as interior partitions. However, systems tested vertically (walls

Where joint treatment is discontinued at or just above the ceiling line, the vertical joint shall be

- and partitions) shall not be permitted to be arbitrarily used in a horizontal orientation.
14. Metal studs and runners are nominal 25 gage unless otherwise specified.
  15. Greater stud sizes (depths) shall be permitted to be used in metal- or wood-stud systems. Metal studs of heavier gage than those tested shall be permitted. The assigned rating of any load-bearing system shall also apply to the same system when used as a nonload-bearing system. Indicated stud spacings are maximums.
  16. Specified floor-ceiling and roof-ceiling framing sizes or truss dimensions are minimums. Greater joist or truss sizes (depths) shall be permitted to be used in metal- or wood-framed systems. Indicated joist and truss spacings are maximums.
  17. Within design limitations, the distance between parallel rows of studs, such as in a chase wall, shall be permitted to be increased beyond that tested. When stud cavities in walls constructed of parallel rows of steel studs exceed 9 $\frac{1}{2}$  inches and cross bracing is required the cross bracing shall be fabricated from steel studs.
  18. Systems tested with metal furring channels attached directly to the bottom chords of steel beams, bar joists, or wood trusses or framing shall be permitted to be suspended. Generally, furring channels are attached to 1 $\frac{1}{2}$  inch cold rolled carrying channels 48 inches o.c. suspended from joists by 8 gage wire hangers spaced not greater than 48 inches o.c.
  19. Floor-ceiling and roof-ceiling systems were fire tested at less than 36 inches total depth. However, the total depth of the systems, with either directly attached or suspended ceiling membranes, shall be permitted to extend greater than 36 inches.
  20. Where laminating compound is specified, taping, all-purpose, and setting type joint compounds shall be permitted.
  21. Additional layers of type X or regular gypsum panels shall be permitted to be added to any system.
  22. When not specified as a component of a fire-resistance rated wall or partition system, wood structural panels shall be permitted to be added to one or both sides. Such panels shall be permitted to be applied either as a base layer directly to the framing (under the gypsum board), as a face layer (over the face layer of gypsum board), or between layers of gypsum board in multi-layer systems. When such panels are applied under the gypsum board or between layers of gypsum board the length of the fasteners specified for the attachment of the gypsum board applied over the wood structural panels shall be increased by not less than the thickness of the wood structural panels. Fastener spacing for the gypsum board and the number of layers of gypsum board shall be as specified in the system description.
  23. Each proprietary system lists specific products that are acceptable for use in the specific system in which they are listed. Consult the manufacturer for information on additional proprietary products that are suitable for use in specific proprietary systems.



## TESTING AGENCIES

Each detailed description is accompanied by a cross-section detail of the system. Also included is design information giving total thickness, limiting height where appropriate, and approximate weight of the system in pounds per square foot. Fire and sound test references identifying the agency which certified the test as well as a report number and date are also provided (see Tables I and II).

**TABLE I  
FIRE TESTING AGENCIES**

BMS	Building Materials & Structures, National Bureau of Standards (now National Institute of Standards and Technology)
CTC	Commercial Testing Company
FM	Factory Mutual Research Corporation
GET	George E. Troxell, P.E., Consulting Engineer
ITS	Intertek Testing Services NA Inc.
NBS	National Bureau of Standards (now National Institute of Standards and Technology)
NRCC	National Research Council of Canada
OPL	Omega Point Laboratories, Inc.
OSU	The Ohio State University
PCA	Portland Cement Association
SFT	Standard Fire Test, Fire Prevention Research Institute
SWRI	Southwest Research Institute
UC	University of California
UL	Underwriters Laboratories Inc.
ULC	Underwriters' Laboratories of Canada
WFCi	Western Fire Center, Inc.
WHI	Warnock Hersey, Inc. (now Intertek Testing Services NA Inc.)

**TABLE II  
SOUND TESTING AGENCIES**

ACI	Acoustical Consultants, Inc.
ASL	Acoustic Systems Acoustical Research Facility
BBN	Bolt, Beranek, and Newman, Inc.
BGL	British Gypsum Limited
BMS	Building Materials & Structures, National Bureau of Standards (now National Institute of Standards and Technology)
CK	Cedar Knolls Acoustical Laboratories (now Noise Unlimited, Inc.)
DRC	Domtar Research Center
G&H	Geiger and Hamme
INTEST	International Acoustical Testing Laboratories
KAL	Kodaras Acoustical Laboratories (now Electrical Testing Laboratories, ETL)
KG	Kaiser Acoustical Laboratories
NBS	National Bureau of Standards (now National Institute of Standards and Technology)
NGC	National Gypsum Company's Gold Bond Acoustical Laboratories (now NGC Testing Services)
NRCC	National Research Council of Canada
OL	Orfield Laboratories, Inc.
OR	Ohio Research Corporation
RAL	Riverbank Acoustical Laboratories
SA	Shiner & Associates
USG	USG Research & Technology Center
WEAL	Western Electro Acoustical Laboratory, Inc.
WHI	Warnock Hersey, Inc. (now Intertek Testing Services NA Inc.)

**PRODUCT IDENTIFICATION**

All gypsum products are identified with the manufacturer's name and trademark. The thickness and type of gypsum board are shown on the end bundling tape or on the board. Ready-mixed joint compounds are identified on the container. Bagged products are identified on the bag.

ASTM standard product specifications are shown in Table III.

**TABLE III  
APPLICABLE ASTM PRODUCT STANDARDS**

<u>Product</u>	<u>ASTM</u>
Gypsum Board	C 1396*
Gypsum Wallboard	C 1396, Sec. 5*
Predecorated Gypsum Board	C 1396, Sec. 5*
Gypsum Lath	C 1396, Sec. 11*
Gypsum Sheathing Board	C 1396, Sec. 9*
Gypsum Backing Board	C 1396, Sec. 6*
Gypsum Coreboard	C 1396, Sec 6*
Gypsum Shaftliner Board	C 1396, Sec. 6*
Water-Resistant Gypsum Backing Board	C 1396, Sec. 7*
Gypsum Ceiling Board	C 1396, Sec. 12*
Exterior Gypsum Soffit Board	C 1396, Sec. 8*
Gypsum Base for Veneer Plasters	C 1396, Sec. 10*
Glass Mat Gypsum Panels	C 1658
Glass Mat Gypsum Substrate for Use as Sheathing	C 1177
Glass Mat Water-Resistant Gypsum Backing Panel	C 1178
Fiber Reinforced Gypsum Panels	C 1278
Joint Compound	C 475
Gypsum Plasters	C 28
Gypsum Veneer Plaster	C 587
Metal Lath	C 847
Accessories for Gypsum Wallboard and Gypsum Veneer Base	C 1047
Nails for the Application of Gypsum Board	C 514
Steel Drill Screws for the Application of Gypsum Panel Products or Metal Plaster Bases (Types G, W, and S)	C 1002
Steel Drill Screws for the Application of Gypsum Panel Products or Metal Plaster Bases to Steel Studs from 0.033 in. (0.84 mm) to 0.112 in. (2.84 mm) in Thickness (Type S-12)	C 954
Nonstructural Steel Framing Members	C 645
Load-Bearing (Transverse and Axial) Steel Studs, Runners (Tracks), and Bracing or Bridging for Screw Application of Gypsum Panel Products and Metal Plaster Bases	C 955

\* ASTM Specification C 1396 is a consolidation of previous ASTM Standards C 36, C 37, C 79, C 442, C 588, C 630, C 931, C 960, and C 1395, which have been withdrawn.

**ABBREVIATIONS**

Abbreviations used in this Manual are shown in Table IV (also see Tables I and II on page 10).

**TABLE IV  
ABBREVIATIONS**

ASTM	ASTM International (formerly American Society for Testing and Materials)
C&P	carpet and pad
dB	decibel
dia	diameter
DOC	U. S. Department of Commerce
est	estimated
FSTC	Field Sound Transmission Class
FSTL	Field Sound Transmission Loss
ft	foot
ga	gage or gauge
galv	galvanized
Hz	hertz (cycles/second)
hr	hour
IIC	Impact Insulation Classification
in.	inch
lab	laboratory
lb	pound
mfr	manufacturer
mm	millimeter
min	minimum
nom	nominal
NLB	nonload-bearing
o.c.	on center
oz	ounce
pcf	pounds per cubic foot
psf	pounds per square foot
rev	revised
sq	square
STC	Sound Transmission Class
STL	Sound Transmission Loss
T&G	tongue and groove

**NOTE:**

ASTM Standards are available from:  
 ASTM International  
 100 Barr Harbor Drive  
 West Conshohocken, PA 19428-2959  
 (610) 832-9585  
 Fax: (610) 832-9555  
 E-mail: [service@astm.org](mailto:service@astm.org)  
 Website: <http://www.astm.org>

## SECTION II - REQUIREMENTS FOR FIRE PROTECTION

### FIRE RESISTIVE PROPERTIES OF GYPSUM

Gypsum is approximately 21 percent by weight chemically combined water which greatly contributes to its effectiveness as a fire resistive barrier. When gypsum board or gypsum plaster is exposed to fire, the water is slowly released as steam, effectively retarding heat transmission (Figure 1). It can, in a sense, be compared to what happens when a blowtorch is turned on a block of ice. Although the ice is being melted, one can hold a hand on the opposite side without being burned. Even though the ice gets very thin it effectively blocks the transfer of the intense heat and one's hand would not be burned until the ice is melted.

When gypsum-protected wood or steel structural members are exposed to a fire, the chemically combined water (being released as steam) acts as a thermal barrier until this slow process, known as calcination, is completed. The temperature directly behind the plane of calcination is only slightly higher than that of boiling water (212°F), which is significantly lower than the temperature at which steel begins losing strength or wood ignites. Once calcination is complete, the in-place calcined gypsum continues to act as a barrier protecting the underlying structural members from direct exposure to flames.

### TYPE X GYPSUM BOARD

ASTM C 1396 describes two types of gypsum board - regular and type X - each providing a different degree of fire resistance. Where fire-resistance rated systems are specified, type X gypsum board is typically required

to achieve the rating. Type X gypsum board is defined in ASTM C 1396 as gypsum board that provides not less than one-hour fire resistance for boards  $\frac{5}{8}$  inch thick or not less than  $\frac{3}{4}$ -hour fire-resistance rating for boards  $\frac{1}{2}$  inch thick, applied parallel with and on each side of load bearing 2x4 wood studs spaced 16 inches on center with 6d coated nails,  $\frac{17}{8}$  inch long, 0.095 inch diameter shank,  $\frac{1}{4}$  inch diameter heads, spaced 7 inches on center with gypsum board joints staggered 16 inches on each side of the partition and tested in accordance with the requirements of ASTM E 119.

In order to qualify for use in generic systems contained in this Manual, the Gypsum Association also requires that  $\frac{1}{2}$  inch type X gypsum board shall achieve a one-hour fire-resistance rating when applied to a floor-ceiling system as described by GA File No. FC 5410 on page 142.

Where  $\frac{3}{4}$  inch or 1 inch gypsum board is described as "type X" in proprietary systems contained in this Manual, consult the manufacturer to determine what specific products are required.

### PERFORMANCE OF GYPSUM PLASTER

Job performance of gypsum plaster systems can be affected by several factors such as: extreme weather conditions, poor or no ventilation, thermal shock, unusual framing or frame loading, etc. Precautions shall be taken to prevent these and other adverse conditions.

Mix ratios such as 1:2 gypsum-perlite, -vermiculite, or -sand are used to describe a mixture consisting of 100 pounds of gypsum plaster to 2 cubic feet of

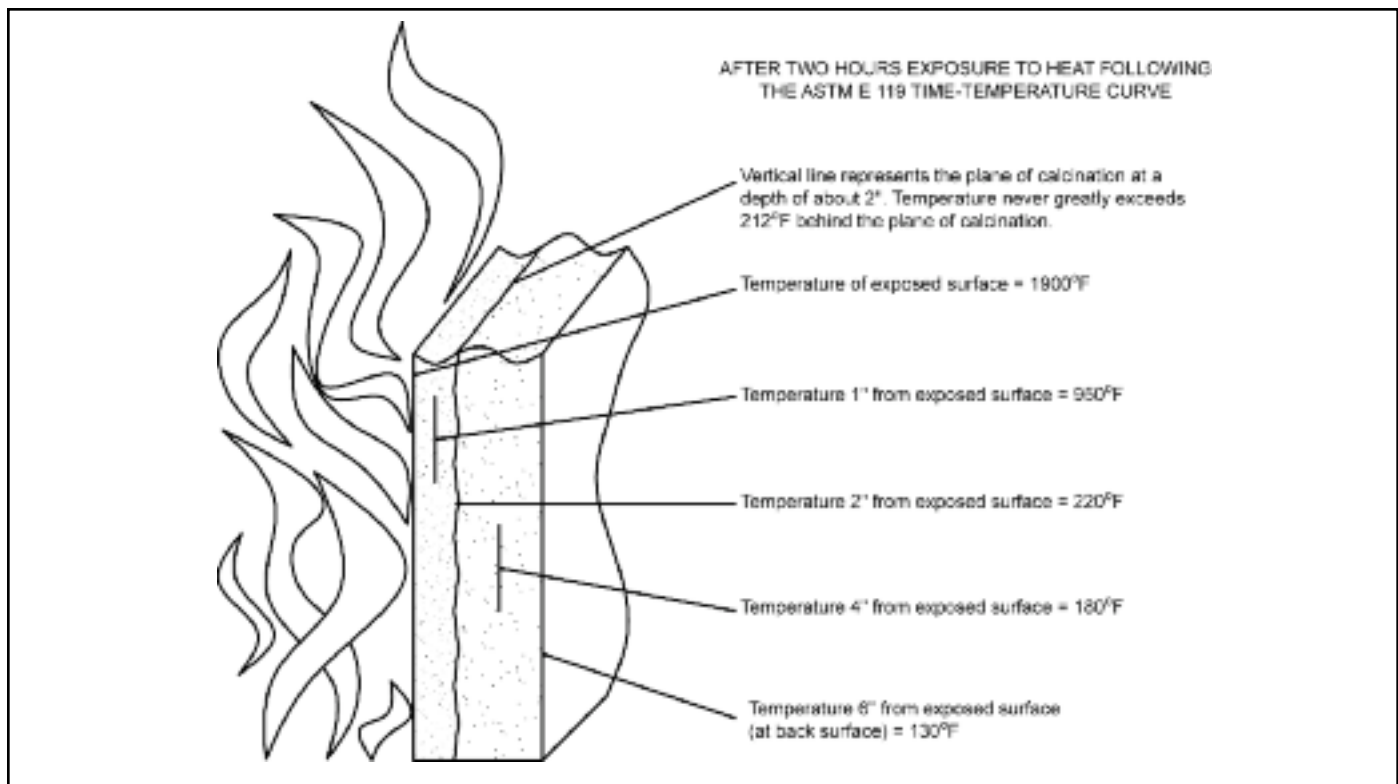

**Figure 1**  
**How Gypsum Retards Heat Transmission**

aggregate (3 cubic feet where the ratio is given as 1:3). Many fire tests have been conducted to show that 1:2 gypsum-vermiculite mix may be substituted for 1:3 gypsum-vermiculite mix in all fire-resistance rated systems. A 1:2 gypsum-perlite mix may be substituted for 1:3 gypsum-perlite mix in one-hour and two-hour rated systems only. Perlite and vermiculite shall be permitted to be interchanged in one-hour and two-hour rated systems.

Plaster thicknesses are measured from the face of the lath, regardless of the plaster base used.

### FIRE RESISTANCE TESTS

All fire-resistance classifications described in this Manual are derived from full-scale fire tests conducted in accordance with the requirements of ASTM E 119 or CAN/ULC-S101 (as amended and in effect on the date of the test) by recognized independent laboratories. Fire-resistance classifications are the results of tests conducted on systems made up of specific materials put together in a specified manner.

There are a number of nationally recognized laboratories capable of conducting tests to establish fire-resistance classifications according to the procedures outlined in ASTM E 119 or CAN/ULC-S101. The conditions under which tests are conducted are thoroughly detailed and the fire-resistance classification is established as the time at which there is excessive temperature rise, passage of flame, or structural collapse. In addition, failure may result because of penetration by the pressurized hose stream required in the fire test procedure for walls.

With reference to all tested systems, ASTM E 119 states:

It is the intent that classifications shall register performance during the period of exposure and shall not be construed as having determined suitability for use after fire exposure.

Comprehensive research by fire protection experts has determined the average combustible content normally present within any given occupancy. In addition, evacuation times, the time required for the contents to be consumed by fire, and the resulting temperature rise have been quantified. Fire-resistance requirements are established accordingly in building codes and similar regulations.

In ASTM E 119 fire tests, wall, ceiling, column, and beam systems are exposed in a furnace which reaches the indicated average temperatures at the time stated in the standard time-temperature curve (Figure 2) and Appendix X1 of ASTM E 119. The unexposed surface of all systems refers to the surface away from the fire during a test. The exposed surface refers to the surface facing the fire.

### WALL AND PARTITION SYSTEMS

All walls and partitions tested and classified are required to be at least 100 square feet in area with no edge dimension less than nine feet. Surface temperatures on the unexposed side of the test specimen are measured at a minimum of nine locations.

When load-bearing walls and partitions are tested, the applied load is required to simulate the working stresses of the design.

Walls and partitions are required to stop flame or hot gases capable of igniting cotton waste. The average temperature of the unexposed surface is not permitted to increase more than 250°F above ambient nor is any individual thermocouple permitted to rise more than 325°F above ambient. A duplicate of the system (rated for one-hour fire resistance or more) is fire tested for one-half the specified fire-resistance period, but no longer than one-hour, after which it is required to withstand the impact, erosion, and cooling effect of a hose stream.

Openings in walls for fire door frames and fire window frames shall be coordinated between the architect, the general contractor, the drywall contractor, and the frame supplier to ensure that installation details for the wall and the frame are considered. The installation instructions supplied with frames vary and shall be followed to comply with local code requirements. All fire door and fire window assemblies are required to be installed in accordance with ANSI/NFPA 80 and subject also to the conditions, limitations, and/or allowances of their certification label and listing.

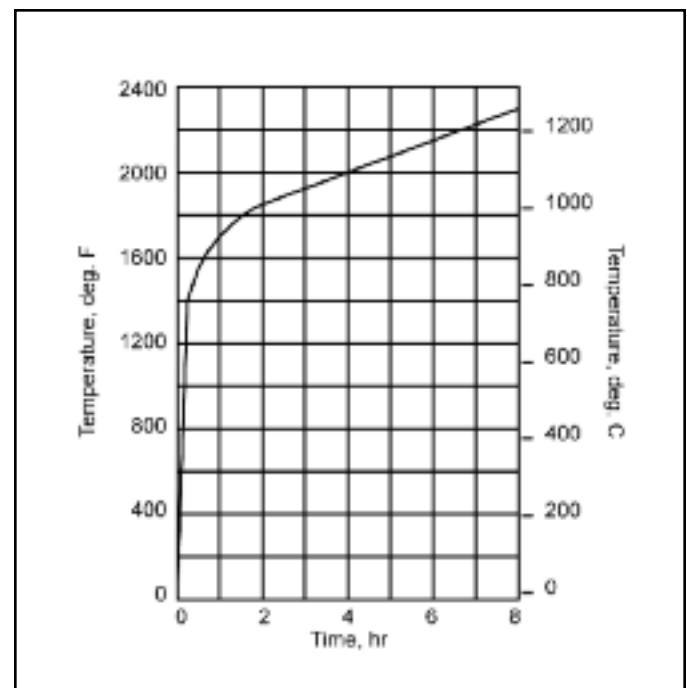

**Figure 2**  
**Standard Time-Temperature Curve**  
**(ASTM E 119)**

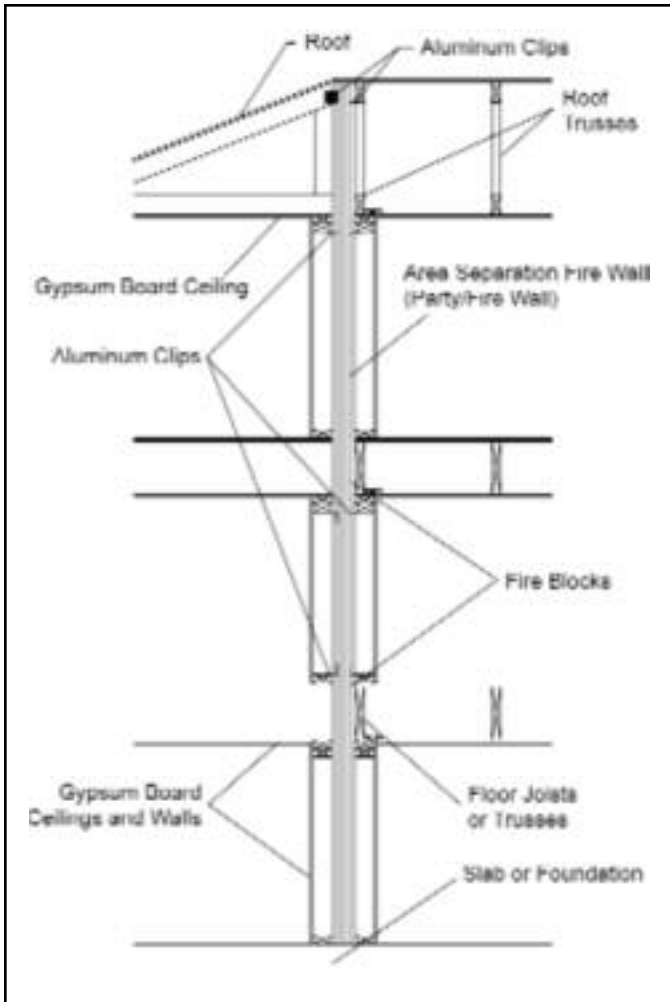

**Figure 3**  
**Typical Gypsum Board Area**  
**Separation Fire Wall Construction**

### **AREA SEPARATION FIRE WALLS (PARTY/FIRE WALLS)**

Fire-resistance rated gypsum board systems (solid and cavity types) can serve as area separation fire walls (also known as party walls or fire walls) between adjacent wood frame and steel frame dwelling units such as townhouses, condominiums, and apartments; and in commercial and institutional buildings. These walls are erected one floor at a time, beginning at the foundation and continuing up to or through the roof. At intermediate floors metal floor/ceiling track shall be installed back-to-back to secure the top of the lower section of the partition to the bottom of the next section being installed.

At intermediate floors and other specified locations the area separation fire walls shall be attached to adjacent wood or steel framing on each side with aluminum clips that soften when exposed to fire (Figure 3). If one side of the structure becomes involved in a fire, the clips on the fire side allow collapse of the structure on that side. The clips on the other side support the area separation fire wall keeping it in place, thereby protecting the adjacent structure. Consult gypsum board manufacturer for clip detail, placement, and height limitations. Openings and through penetrations, including protected openings and penetrations, are not permitted in the area separation fire walls contained in this manual.

### **FLOOR-CEILING AND ROOF-CEILING SYSTEMS**

Floor-ceiling and roof-ceiling systems tested and classified are required to be a minimum of 180 square feet in area with their shortest edge dimension not less than 12 feet. The system is required to sustain the design load throughout the test and not permit the passage of either flame or hot gases capable of igniting cotton waste. Surface temperatures on the unexposed side of the test specimen are measured at a minimum of nine locations. The average temperature of the unexposed surface is not permitted to increase more than 250°F above ambient nor is any individual thermocouple permitted to rise more than 325°F above ambient.

#### **Ceiling Openings**

Many fire-resistance rated floor-ceiling systems have been tested with openings through the ceiling membrane for air ducts, electrical outlets, and lighting fixtures.

Building codes permit air duct openings in most ceiling systems when the air duct openings are protected with approved ceiling dampers.

Building codes also permit membrane penetrations in maximum two-hour fire-resistance-rated horizontal systems by steel outlet boxes that do not exceed 16 square inches in area provided the aggregate area of such penetrations does not exceed 100 square inches in any 100 square feet of ceiling area and the annular space between the ceiling membrane and the box does not exceed 1/8 inch.

Many approved recessed lighting fixtures require special protection. Consult the fire test report or listing for the specific system for protection details and the opening area limitation.

## BEAM, GIRDER, AND TRUSS PROTECTION SYSTEMS

Beams are tested with superimposed loads applied to simulate the maximum theoretical dead and live loads permitted by nationally recognized design standards. A fire-resistance rating is established for a system when the test specimen supports the load during the test and meets specific temperature requirements for the prescribed period. Beams, girders, and trusses shall be protected by either (1) a continuous ceiling membrane of either gypsum lath and plaster or gypsum board or (2) enclosing them individually.

### Continuous Ceiling Protection

Building codes allow for the use of the gypsum board or gypsum lath and plaster ceilings described in the Floor-Ceiling Systems portion of this Manual for beam or girder protection. The complete floor-ceiling system shall provide no less than the rating required for the structural member being protected.

If the bottom of the beam projects 6 inches or less below the plane of the ceiling, the ceiling is furred down and around the beam (Figure 4). If the projection is greater than 6 inches, the gypsum board or lath and plaster beam protection system shall extend from the ceiling to the floor above. (See Individual Encasement Protection.)

A ceiling used as membrane fireproofing usually consists of either gypsum board or gypsum plaster over gypsum or metal lath. These systems may be either attached directly to or suspended from the primary structural elements. The tested assembly consists of the ceiling membrane, beams, girders, joists, or trusses and the floor or roof deck system above.

### Individual Encasement Protection

Individual encasement of beams, girders, and trusses with gypsum lath and plaster or gypsum board (Figure 5) is permitted where one or more of the following conditions exist.

1. When the fire-resistance requirement for the beam, girder, or truss is greater than the fire-resistance requirement for the floor-ceiling or roof-ceiling system being supported. Where there are relatively few three-hour or four-hour protected beams or girders, and only a two-hour floor-ceiling requirement, it is generally uneconomical to use a three-hour or four-hour floor-ceiling system throughout, or
2. When either no ceiling is required or a non-rated ceiling is used, or
3. When the bottom of the beam projects greater than 6 inches below the plane of the ceiling.

When structural members support more than one floor, or a floor and a roof, consult local building codes for requirements.

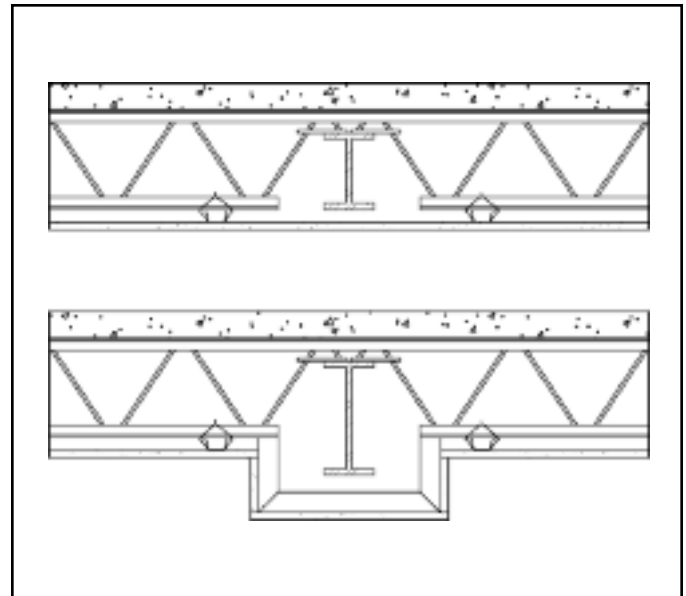

**Figure 4**  
**Membrane Protected Steel Beam- Continuous**

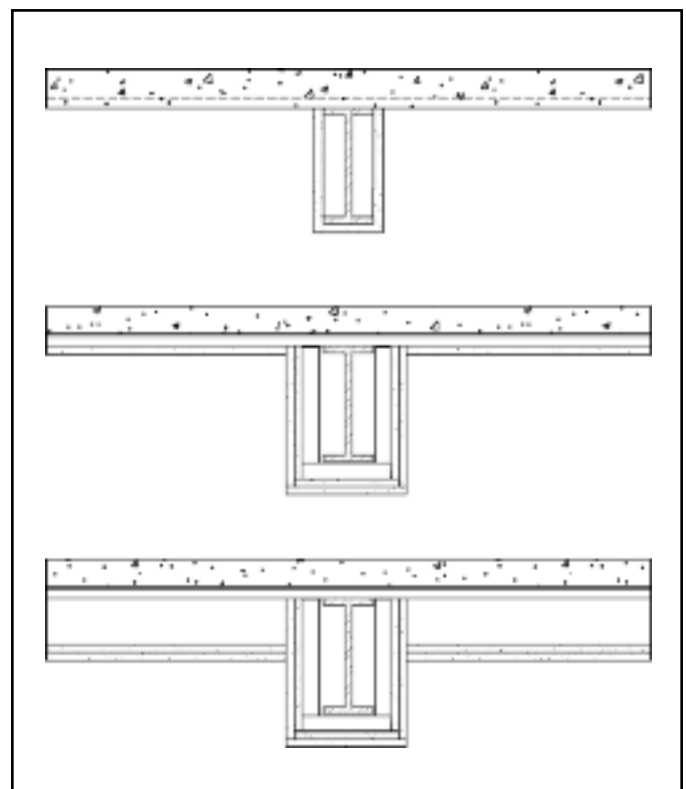

**Figure 5**  
**Steel Beam - Individual Encasement Protection**

**COLUMN PROTECTION SYSTEMS**

Columns are tested under a temperature limit criteria. The temperature of the steel is measured by not less than four thermocouples at each of four levels. A test is successful when the average temperature of any level does not exceed 1000°F and no individual thermocouple exceeds 1200°F within the prescribed time period.

All column systems in this Manual were tested with the column size specified in the system. Fire-resistance ratings for the heavier steel columns are not applicable to the lighter steel columns.

Typical column protection systems are shown in Figures 6 and 7.

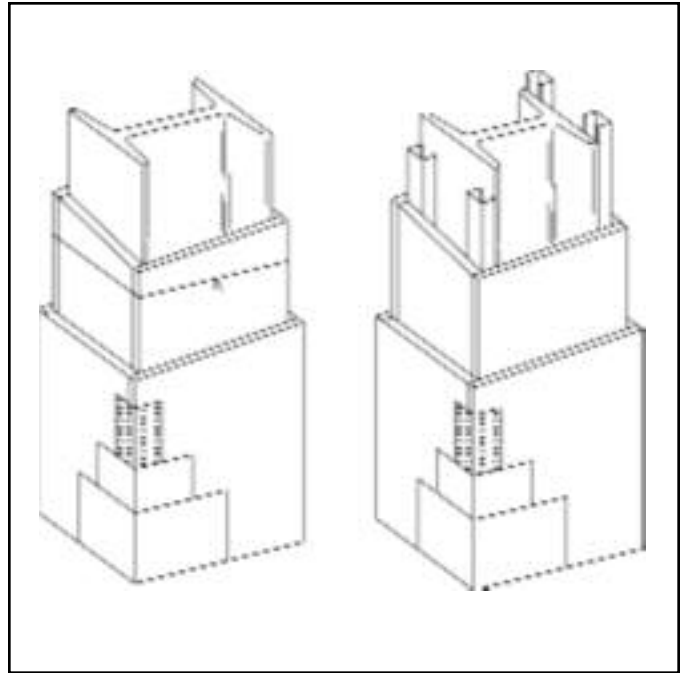

**Figure 6**  
**Column Protection -**  
**Gypsum Board or Veneer Base**

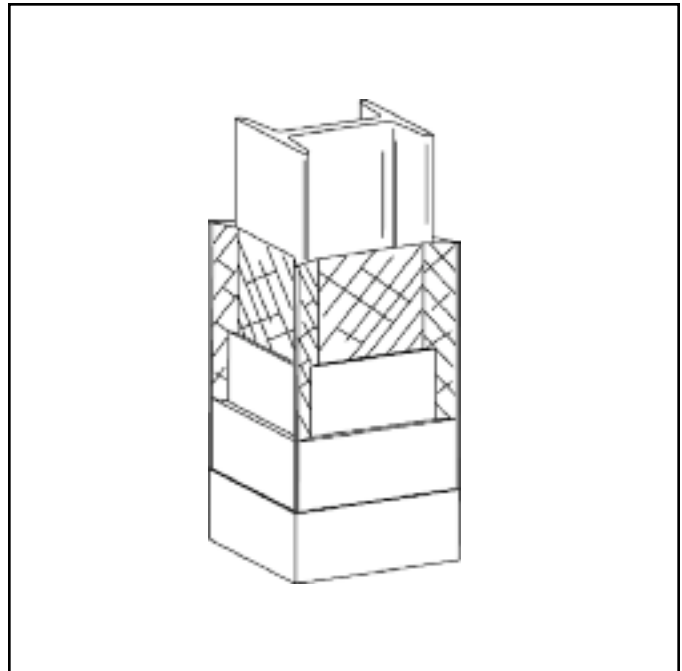

**Figure 7**  
**Column Protection -**  
**Metal Lath and Plaster**

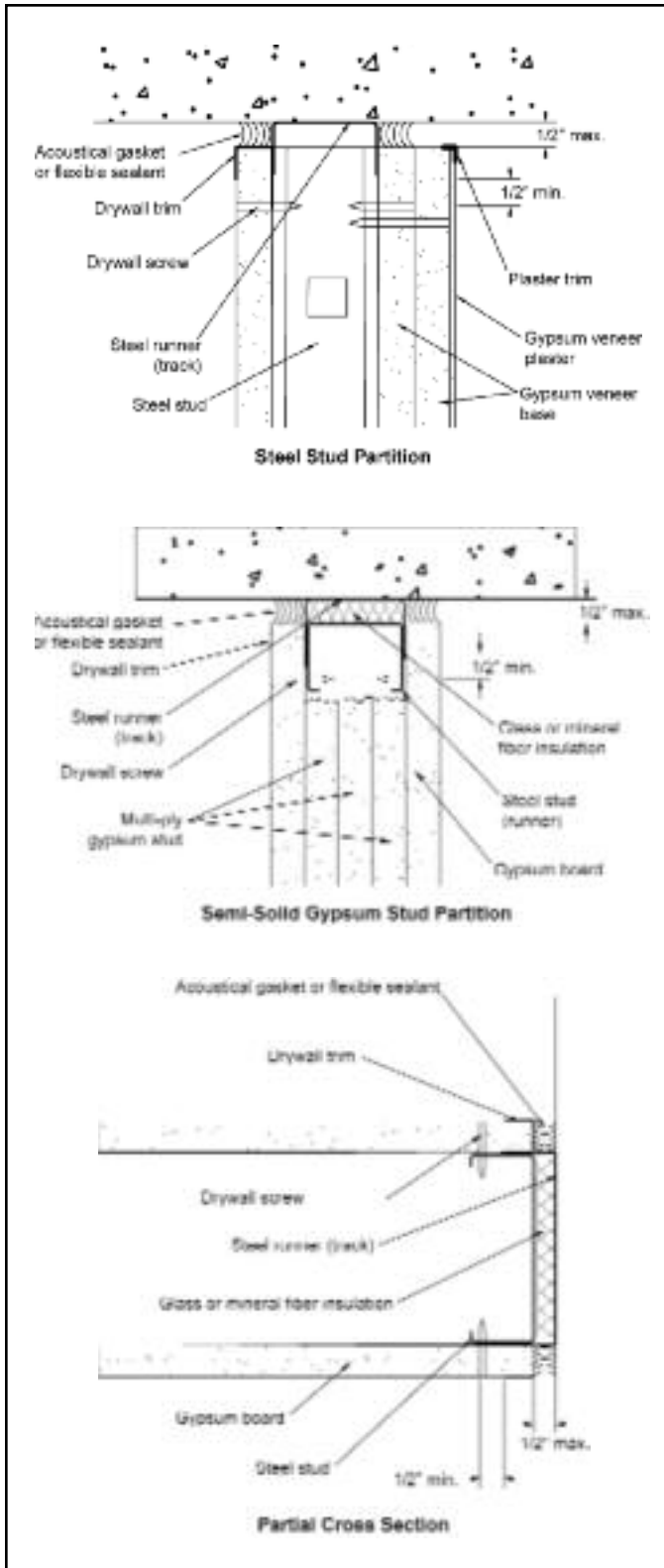

**Figure 8**  
**Perimeter Relief Details**  
 (FM 16738.69, 6/18/69; UL R4024-7-8, 6/23/66)

**FIRE BLOCKING**

All fire-resistive systems shall be fire blocked in accordance with applicable code requirements.

All penetrations in a fire rated system shall be filled with firestopping material as required by the local code.

**SMOKE BARRIERS**

Building codes require certain designated wall and ceiling systems to function as "smoke barriers" which are defined in the codes as continuous membranes that resist the passage of smoke. Fire-resistive gypsum systems with perimeters and penetrations sealed to achieve listed STCs also function to resist the passage of smoke.

Minimum one-hour fire-resistance rated gypsum board systems with joints finished in accordance with Level 1 as specified in GA-214, *Recommended Levels of Gypsum Board Finish*, (all joints and interior angles shall have tape embedded in joint compound) with perimeters and penetrations sealed with an approved sealant satisfy building code requirements for a smoke barrier.

**PERIMETER RELIEF AND CONTROL JOINTS**

Engineering studies and fire tests have been conducted on perimeter relief and control joint systems. This research demonstrates that the perimeter relief systems detailed in Figure 8 can be used in most nonload-bearing metal stud partition systems without reducing the fire-resistance rating of the partition. The research also demonstrates that the control joint systems detailed in Figure 9 on page 18 can be used in all one-hour or two-hour, load-bearing or nonload-bearing, wood or steel framed, wall and partition systems in this Manual without adversely affecting the fire-resistance rating. The tests were conducted in accordance with ASTM E 119 and utilized perimeter relief systems and control joint systems as detailed herein. Other similar systems are available from individual manufacturers.



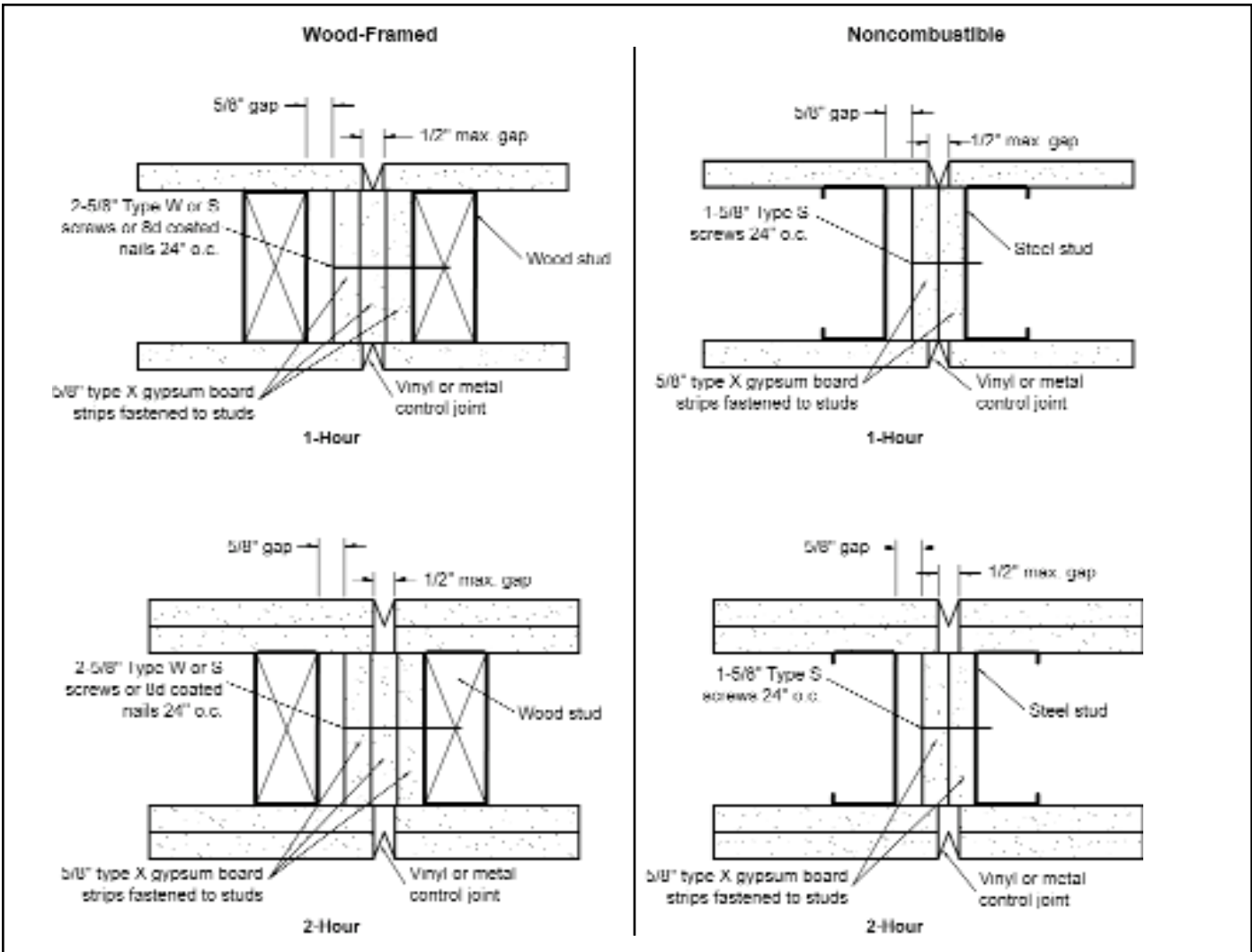

**Figure 9**  
**Control Joint Details**  
 (WHI-651-0318-1, 3/20/90; WHI-647-3024, 9/20/91)

**SURFACE BURNING CHARACTERISTICS**

The test method used to establish surface burning characteristics is ASTM E 84 or CAN/ULC-S102, commonly referred to as the Tunnel Test. This test measures the relative flame spread and relative amount of smoke generated by the material being tested when compared to inorganic reinforced cement board and red oak flooring. Table V lists typical surface burning characteristics for gypsum products as well as the standard materials referenced in the test method.

Surface burning characteristics are intended to be used as a guide in the selection and use of interior finish materials and are obtained under controlled laboratory conditions.

TABLE V SURFACE BURNING CHARACTERISTICS		
	FLAME SPREAD	SMOKE DEVELOPED
Inorganic Reinforced Cement Board	0	0
<b>Gypsum Plaster</b>	<b>0</b>	<b>0</b>
<b>Glass Mat Gypsum Substrate for Use as Sheathing</b>	<b>0</b>	<b>0</b>
<b>Fiber Reinforced Gypsum Panels</b>	<b>5</b>	<b>0</b>
<b>Gypsum Lath</b>	<b>10</b>	<b>0</b>
<b>Exterior Gypsum Soffit Board</b>	<b>15</b>	<b>0</b>
<b>Gypsum Wallboard</b>	<b>15</b>	<b>0</b>
<b>Gypsum Sheathing</b>	<b>15</b>	<b>0</b>
<b>Water-Resistant Gypsum Backing Board</b>	<b>15</b>	<b>0</b>
Red Oak	100	100

## SECTION III - SOUND CONTROL

### SOUND INSULATION

The first essential for airborne sound insulation using any system is to close off air leaks and/or flanking paths by which noise can go through or around the system. Small cracks or holes will increase the sound transmission at the higher frequencies. This can have a detrimental effect on the overall acoustical performance and the STC, particularly for higher rated systems. Failure to observe special construction and design precautions can reduce the effectiveness of the best planned sound control methods.

*Systems shall be airtight.* Recessed wall fixtures, such as medicine cabinets or electrical, telephone, television, and intercom outlets, that penetrate the gypsum board shall not be located back-to-back or in the same stud cavity. Any opening for fixtures or pipes shall be cut to the proper size and sealed. The entire perimeter of a sound insulating system shall be made airtight to prevent sound flanking. Flexible sealant or an acoustical gasket shall be used to seal between the STC rated system and all dissimilar surfaces and also between the system and similar surfaces where perimeter relief is required. TAPING GYPSUM BOARD WALL AND WALL-CEILING INTERSECTIONS PROVIDES AN ADEQUATE AIR SEAL AT THESE LOCATIONS. ASTM E 497, *Standard Practice for Installing Sound-Isolating Lightweight Partitions*, provides additional information. Consult the

manufacturer of the gypsum board for any special recommendations.

Systems are grouped in ranges according to their Sound Transmission Class (STC) or Field Sound Transmission Class (FSTC). The higher ranges are shown first. All of the sound tests referenced were conducted according to the requirements of either ASTM E 90, for laboratory tests, or ASTM E 336, for field tests. The designer shall adhere to the specified materials and construction details for STC and FSTC rated systems, particularly in plaster systems, because substitution of lightweight aggregates for sand, or reduction of the sand proportion, may reduce the rating. ALL OPENINGS THROUGH THE SYSTEM, AND ITS ENTIRE PERIMETER, SHALL BE SEALED AIRTIGHT.

SUBSTITUTING MECHANICAL FASTENERS FOR ADHESIVES, OR THE USE OF MORE FASTENERS, MAY AFFECT THE RATING.



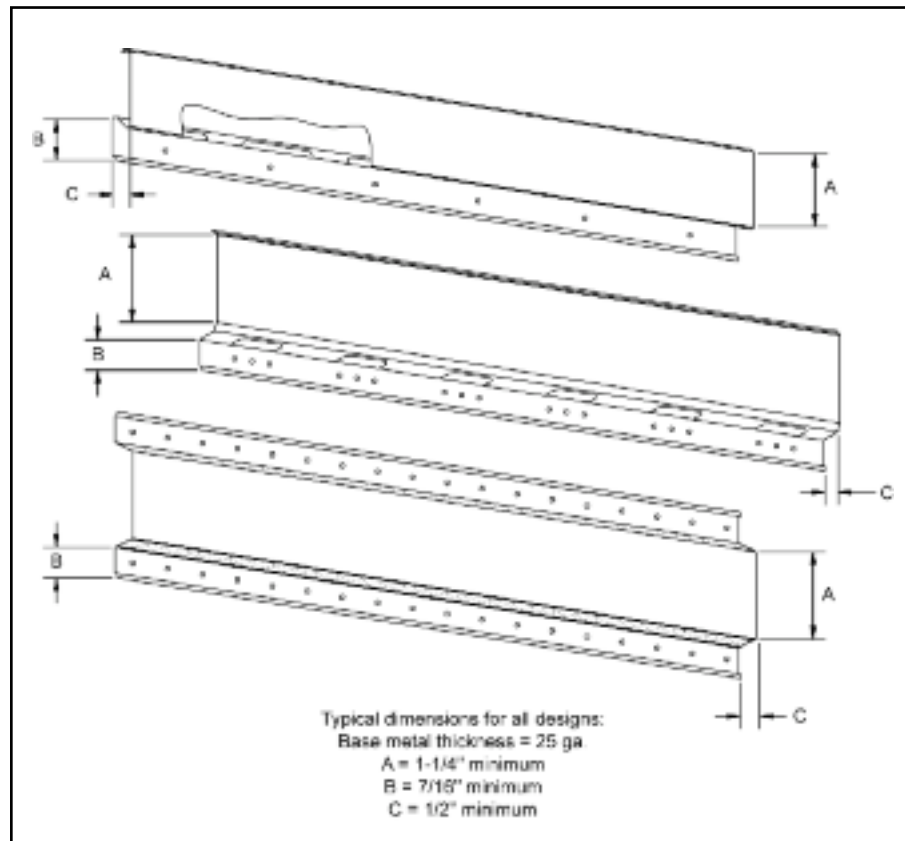

Details of sound tests issued by sound testing agencies are on file and a summary is available from the Gypsum Association or the test sponsor.

Figure 10 shows three typical resilient channel configurations. Where resilient channels are included in systems, the resilient channels are shown by a dashed line to distinguish them from rigid furring channels. Figure 11 on page 20 distinguishes between standard construction practices and those practices recommended for improved sound control.

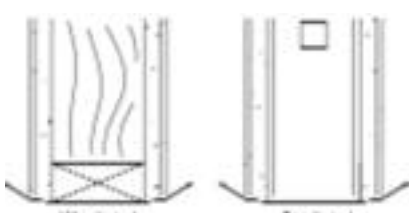
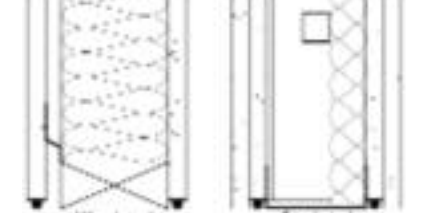

**Figure 10**  
**Resilient Furring Channels**

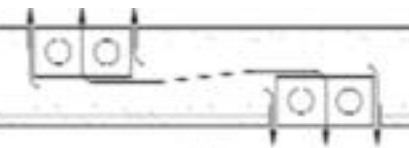
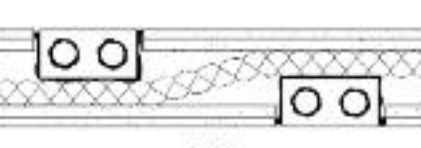
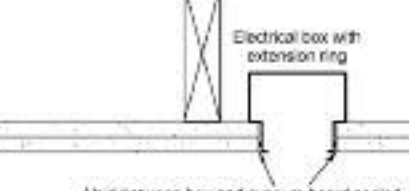
**Figure 11**  
**Sound Isolation Construction**

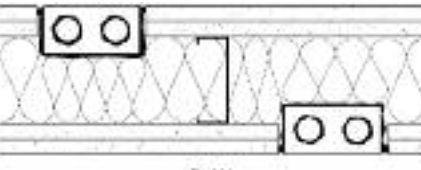
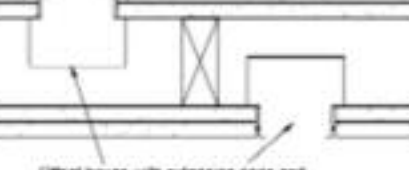
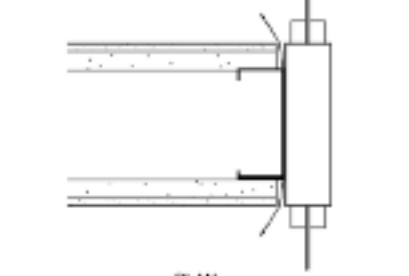
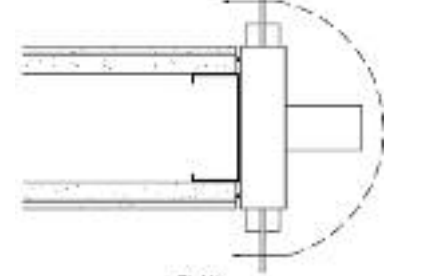
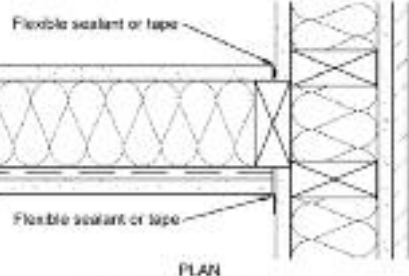
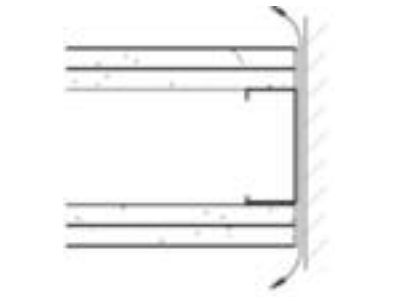
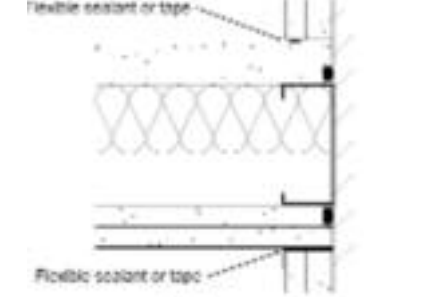
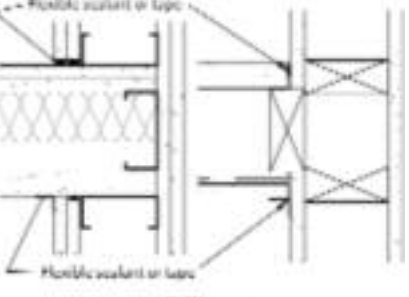
<p>“NORMAL” CONSTRUCTION ARROWS SHOW FLANKING PATHS</p>	<p>“SELECT” CONSTRUCTION SEALING OF RELIEF DETAIL AT PERIMETER OF PARTITION AND AROUND CUT-OUTS TO PREVENT SOUND LEAKAGE</p>	<p>“PRE-DESIGN” CONSTRUCTION SIMULATED LABORATORY CONDITIONS</p>
 <p>Wood stud system      Steel stud system</p> <p>ELEVATION Under and over partitions</p>	 <p>Wood stud system      Steel stud system</p> <p>ELEVATION 1 inch/25 mm sealant</p>	 <p>14" perimeter relief and sealant to seal against sound leaks</p> <p>Gasket impedes structural flanking through floor</p> <p>ELEVATION</p>
 <p>PLAN Through partition openings outlet boxes</p>	 <p>PLAN Sealing of openings through penetrations</p>	 <p>Electrical box with extension ring</p> <p>Void between box and gypsum board sealed</p> <p>ELEVATION Typical floor-ceiling or roof detail</p>
 <p>PLAN Through-penetration openings outlet boxes</p>	 <p>PLAN Boxes offset one stud space and sealing of openings through partitions</p>	 <p>Offset boxes with extension rings and sealed openings</p> <p>PLAN Outlet box detail</p>
 <p>PLAN Flanking at partition-mullion intersection</p>	 <p>PLAN Typical partition-mullion intersection</p>	 <p>Flexible sealant or tape</p> <p>Flexible sealant or tape</p> <p>PLAN Intersection with exterior wall</p>
 <p>PLAN Steel stud flanking around partition ends</p>	 <p>Flexible sealant or tape</p> <p>Flexible sealant or tape</p> <p>PLAN Intersection with interior wall</p>	 <p>Flexible sealant or tape</p> <p>Flexible sealant or tape</p> <p>Flexible sealant or tape</p> <p>PLAN Typical partition intersection</p>

## SOUND TRANSMISSION LOSS TESTS

ASTM E 90, *Standard Test Method for Laboratory Measurement of Airborne Sound Transmission Loss of Building Partitions*, is the procedure for measuring the sound transmission loss (STL) in a laboratory. The STL is the difference between the sound energy (sound pressure level) in a source room and a receiving room when the two rooms are separated by the system being tested.

ASTM E 336, *Standard Test Method for Measurement of Airborne Sound Insulation in Buildings*, is the procedure to determine the field sound transmission loss (FSTL) between two rooms under field conditions.

The STL or the FSTL is measured at  $1/3$  octave test frequencies (Hz) as follows and the sound transmission loss curve is plotted:

125	315	800	2000
160	400	1000	2500
200	500	1250	3150
250	630	1600	4000

A system's overall effectiveness in resisting the transmission of airborne sound, whether it is a wall, partition, or floor-ceiling, is reported as a single number derived from an analysis of the STL or FSTL curve. This rating is the Sound Transmission Class (STC) or Field Sound Transmission Class (FSTC). This Manual uses STC/FSTC ranges to make comparing systems more significant.

ASTM E 413, *Classification for Rating Sound Insulation*, is the method used to derive the STC/FSTC from the STL/FSTL curve. Using the rules stated in ASTM E 413, a reference contour is fitted to the sound transmission loss curve. The STC/FSTC is the point where the reference contour crosses the 500 Hz line.

The reference contour, shown by the dashed line in Figure 12, has a flat portion from 4000 Hz to 1250 Hz. It drops 5 dB between 1250 Hz and 400 Hz, and 15 dB between 400 Hz and 125 Hz. In fitting the reference contour to the measured curve, the following conditions are required to be met:

1. The STL curve is not permitted to be greater than 8 dB below the reference contour at any test frequency, and
2. The sum of the dB differences between the points on the reference contour and the corresponding points on the STL curve at each of the test frequencies is not permitted to be greater than 32 dB.

Some of the STC ratings in this Manual were derived according to slightly different standards in use prior to 1970. For instance, ASTM E 90-61T, the previous sound test procedure, called for measurements at  $1/2$  octave frequencies, and the rules for fitting the standard curve were different.

The smallest dimension of the system tested in accordance with ASTM E 90 is not permitted to be less

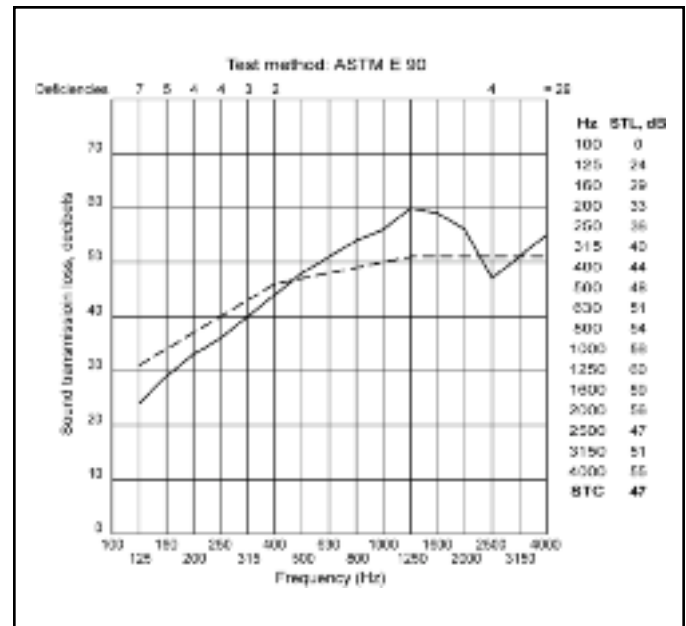

**Figure 12**  
**STL Curve**

than 7 feet, 10 inches and the minimum volume for each of the sound source and receiving rooms is 2,825 cubic feet. The system is constructed to separate the source and receiving rooms, which are arranged so that the only significant sound transmission is through the test specimen.

The source room contains one or more sound sources, a diffusing system such as multiple stationary and/or rotating reflectors, and microphones located to adequately sample the sound field in the space. A single microphone on a rotating boom may be optionally used. The receiving room is similarly equipped, except that the sound source(s) is used only to determine the reverberation time for correction purposes. The sound measurements in both rooms are made according to ASTM E 90.

Research by recognized sound test authorities indicates that the STC's on unsymmetrical walls are not affected by sound testing from either side. Therefore, the laboratory sound source side is not indicated for unsymmetrical systems in this Manual.

## IMPACT NOISE TEST

To determine the Impact Insulation Classification (IIC) of a floor, a standard ISO impact machine with steel hammers taps on a test floor system installed above a special receiving room. Microphones in the receiving room record the average sound pressure level produced by the tapping machine at  $1/3$  octave frequency bands between 100 and 3150 Hz. These measured levels are then normalized to a standard room absorption. The method used is described in ASTM E 492, *Standard Test Method for Laboratory Measurement of Impact Sound Transmission Through Floor-Ceiling Assemblies Using the Tapping Machine*.

The IIC is determined by comparing the normalized impact sound pressure levels at the 16 test frequencies with an IIC reference contour. The reference contour has a flat portion from 100 to 315 Hz, a middle line segment decreasing 5 dB in the interval 315 to 1000 Hz, followed by a high frequency line segment decreasing 15 dB in the interval 1000 to 3150 Hz. In fitting the reference contour to the measured sound pressure levels in the receiving room, the following conditions are required to be met:

1. The noise level at any test frequency is not permitted to be greater than 8 dB above the reference contour, and
2. The sum of the dB differences between the points on the reference contour and the corresponding points on the curve of the normalized impact noise levels at each of the test frequencies is not permitted to be greater than 32 dB.

The IIC for the specimen is the difference between 110 and the value on the normalized impact noise level scale (i.e., ordinate scale) at 500 Hz of the lowest contour for which the above conditions are fulfilled.

The IIC listings for floor-ceiling systems in this Manual are for bare floors (no floor covering) and for the addition of a carpet over a separate pad, which is identified as "C&P."

Although any carpet, with or without a pad, will improve the IIC, a heavy wool carpet over a good quality pad will make a significant improvement, as illustrated for FC 5300 on page 122. The addition of a 44 oz. woven loop pile carpet over a 40 oz. hair felt pad increased the IIC from 38 to 63. The IIC (C&P) listings in this Manual are for the carpet and pad described above for FC 5300 unless otherwise noted. The use of other types of carpets, both with and without pads, will result in increases in the IIC, and in some instances may equal that achieved by use of the aforementioned carpet and pad.

## NOTES

## SECTION IV - FIRE RESISTANCE AND SOUND CONTROL SYSTEMS

### INDEX TO SYSTEMS BY STC RATING

NONCOMBUSTIBLE WALLS & PARTITIONS						WOOD FRAMED WALLS & PARTITIONS	
STC	GA FILE NO.	STC	GA FILE NO.	STC	GA FILE NO.	STC	GA FILE NO.
65 - 69	WP 5060	50 - 54	WP 1021	40 - 44	WP 1204	60 - 64	WP 3010
			WP 1022		WP 1206		
60 - 64	WP 1450		WP 1023		WP 1240	55 - 59	WP 3110
	WP 1451		WP 1041		WP 1290		WP 3810
	WP 2945		WP 1049		WP 1296		WP 3812
	WP 5005		WP 1050		WP 1714		WP 3820
	WP 5006		WP 1051		WP 1716		WP 5510
	WP 5070		WP 1052		WP 6130		WP 5520
	WP 5071		WP 1053		WP 6135		
			WP 1055		WP 6152	50 - 54	WP 3240
55 - 59	WP 1015		WP 1530				WP 3241
	WP 1470		WP 1545	35 - 39	WP 1311		WP 3242
	WP 1505		WP 1546		WP 1330		WP 3243
	WP 1506		WP 1548		WP 1340		WP 3244
	WP 1510		WP 1560		WP 1350		WP 3245
	WP 1515		WP 1565		WP 1370		WP 3260
	WP 1520		WP 1570		WP 1380		WP 3910
	WP 1521		WP 2921		WP 1390		WP 5530
	WP 1522		WP 2922		WP 1400		
	WP 1523		WP 2924		WP 1830	45 - 49	WP 3330
	WP 1524		WP 2925		WP 1841		WP 3340
	WP 2800		WP 2970		WP 1870		WP 3341
	WP 2960		WP 5015		WP 6240		WP 3343
	WP 2961		WP 5017		WP 6250		WP 3360
	WP 2963		WP 5130		WP 6254		WP 3370
	WP 2964		WP 5910				WP 5512
	WP 2965		WP 6525	30 - 34	WP 1930		
	WP 5105					40 - 44	WP 3380
		45 - 49	WP 1070				WP 3430
			WP 1071				WP 3431
			WP 1072				WP 3436
			WP 1073				WP 3441
			WP 1076				WP 4135
			WP 1077				WP 4136
			WP 1078				WP 5515
			WP 1079				
			WP 1081			35 - 39	WP 3510
			WP 1082				WP 3514
			WP 1083				WP 3520
			WP 1084				
			WP 1085				
			WP 1090			30 - 34	WP 3605
			WP 1615				WP 3615
			WP 1616				WP 3620
			WP 1625				
			WP 1630				
			WP 1632				
			WP 1635				
			WP 6010				
			WP 6020				
			WP 6025				
			WP 6040				
			WP 6070				

## INDEX TO SYSTEMS BY STC RATING

SHAFT WALLS		AREA SEPARATION FIRE WALLS		NONCOMBUSTIBLE FLOOR-CEILINGS		WOOD FRAMED FLOOR-CEILINGS	
<u>STC</u>	<u>GA FILE NO.</u>	<u>STC</u>	<u>GA FILE NO.</u>	<u>STC</u>	<u>GA FILE NO.</u>	<u>STC</u>	<u>GA FILE NO.</u>
50 - 54	WP 7051 WP 7052 WP 7053 WP 7056 WP 7057 WP 7060 WP 7061 WP 7062 WP 7064	65 - 69	ASW 0800	60 - 64	FC 1800	60 - 64	FC 5011 FC 5012
45 - 49	WP 6800 WP 7069 WP 7070 WP 7071 WP 7072 WP 7073 WP 7074 WP 7076 WP 7077 WP 7078 WP 7079 WP 7080 WP 7081 WP 7082 WP 7083 WP 7084 WP 7095 WP 7096 WP 7097 WP 7098 WP 7099 WP 7452 WP 7453 WP 7454	60 - 64	ASW 0980 ASW 0985 ASW 0998 ASW 0999 ASW 1000 ASW 1002 ASW 1003 ASW 1004 ASW 1007	55 - 59	FC 1900 FC 1901 FC 1902	55 - 59	FC 5104 FC 5105 FC 5107 FC 5109
		50 - 54	ASW 1100 ASW 1105	50 - 54	FC 1105 FC 2030 FC 3012	50 - 54	FC 5111 FC 5112 FC 5115 FC 5116 FC 5120
		45 - 49	ASW 1201 ASW 1205 ASW 1206 ASW 1207 ASW 1215	<b>STEEL FRAMED FLOOR-CEILINGS WOOD FLOOR</b>  <u>STC</u> <u>GA FILE NO.</u> 50 - 54      FC 4340 45 - 49      FC 4370 35 - 39      FC 4490		45 - 49	FC 5240 FC 5241 FC 5242 FC 5250
40 - 44	WP 6850 WP 6905					40 - 44	FC 5300 FC 5310
35 - 39	WP 7001 WP 7008 WP 7117 WP 7118 WP 7119 WP 7125					35 - 39	FC 5406 FC 5407 FC 5408 FC 5410 FC 5415 FC 5420 FC 5470 FC 5490
30 - 34	WP 7210						



NOTE: Some systems appearing in previous editions have been deleted and are not included in this edition. In addition, several new systems have been added to this edition. The following Table may be helpful.

**DELETED SYSTEMS**

WP 1024  
 WP 1035  
 WP 1054  
 WP 1516  
 WP 3342  
 WP 5016  
 WP 5106  
 WP 6210  
 WP 6220  
 WP 7000  
 WP 7020  
 WP 7252  
 WP 7253  
 WP 7451  
 WP 7491  
 WP 8132  
 ASW 1001  
 ASW 1005  
 ASW 1200  
 ASW 1500  
 FC 5000  
 FC 5106  
 FC 5110  
 FC 5518  
 RC 2605  
 RC 2607  
 CM 2450  
 CM 2451  
 CM 2452  
 CM 3450  
 CM 3451



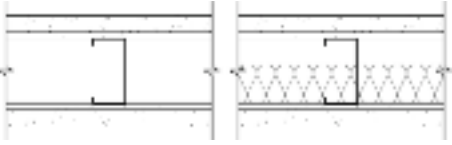
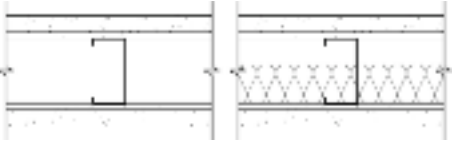
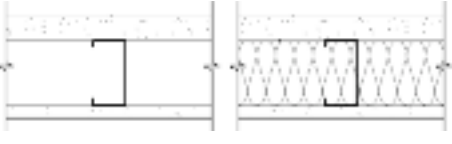
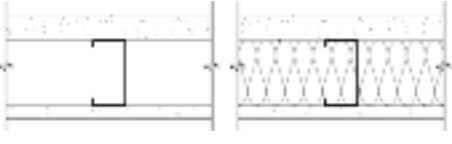
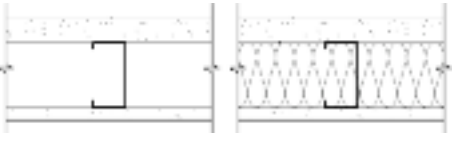
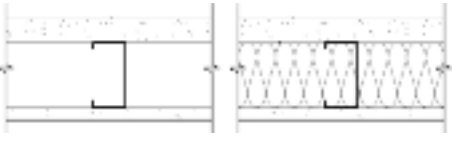

**NEW SYSTEMS**

WP 1049	WP 7261
WP 1055	WP 7262
WP 1077	WP 7263
WP 1078	WP 7453
WP 1079	WP 7454
WP 1083	WP 8007
WP 1084	ASW 0800
WP 1411	ASW 0980
WP 1412	ASW 0985
WP 1413	ASW 0998
WP 1414	ASW 0999
WP 1415	ASW 1006
WP 1416	ASW 1207
WP 1417	ASW 1501
WP 1450	FC 1146
WP 1451	FC 1190
WP 1506	FC 1800
WP 1523	FC 1900
WP 1524	FC 1901
WP 1944	FC 1902
WP 1945	FC 2131
WP 1946	FC 2191
WP 1947	FC 4516
WP 2925	FC 5012
WP 2931	FC 5506
WP 2965	FC 5507
WP 3244	FC 5508
WP 3245	FC 5520
WP 3343	FC 5521
WP 3645	FC 5522
WP 5017	FC 5523
WP 5071	RC 2502
WP 6850	RC 2608
WP 7023	RC 2609
WP 7069	CM 2453
WP 7070	CM 2454
WP 7071	CM 2455
WP 7072	CM 2801
WP 7118	CM 2802
WP 7119	CM 2803
WP 7256	CM 3452
WP 7257	CM 3454
WP 7258	CM 3801
WP 7259	CM 3803
WP 7260	

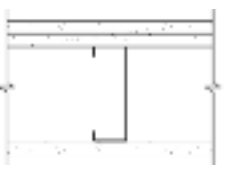
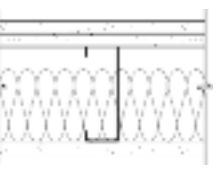

<b>WALLS AND INTERIOR PARTITIONS, NONCOMBUSTIBLE</b>			
<b>GA FILE NO. WP 1015</b>	<b>GENERIC</b>	<b>1 HOUR FIRE</b>	<b>55 to 59 STC SOUND</b>
<b>GYPSUM WALLBOARD, STEEL STUDS</b>			
<p><b>Base</b> layer 1/4" gypsum wallboard applied parallel to each side of 2 1/2" steel studs 24" o.c. with 1" Type S drywall screws 12" o.c. <b>Face</b> layer 5/8" type X gypsum wallboard or gypsum veneer base applied parallel to each side with 1 5/16" Type S drywall screws 12" o.c.</p> <p>Joints staggered 24" each layer and side. Sound tested with 1 1/2" mineral fiber insulation, 3.0 pcf, friction fit in stud space. <b>(NLB)</b></p>			
<b>GA FILE NO. WP 1021</b>	<b>GENERIC</b>	<b>1 HOUR FIRE</b>	<b>50 to 54 STC SOUND</b>
<b>GYPSUM WALLBOARD, STEEL STUDS</b>			
<p>One layer 1/2" type X plain or predecorated gypsum wallboard applied parallel to ONE SIDE of 2 1/2" steel studs 24" o.c. with 1" Type S drywall screws 8" o.c. at vertical joints and 3/8" adhesive beads at intermediate studs.</p> <p>OPPOSITE SIDE: <b>Base</b> layer 1/2" type X gypsum wallboard applied parallel to studs with 1" Type S drywall screws 8" o.c. at vertical joints and 12" o.c. at intermediate studs. <b>Face</b> layer 1/2" type X plain or predecorated gypsum wallboard applied parallel to studs with 1 5/8" Type S drywall screws 8" o.c. at vertical joints and 5/8" adhesive beads at intermediate studs.</p> <p>Joints staggered 24" each layer and side. Sound tested with 3 1/2" glass fiber insulation friction fit in stud space and all layers screw attached without adhesive. <b>(NLB)</b></p>			
<b>GA FILE NO. WP 1022</b>	<b>PROPRIETARY*</b>	<b>1 HOUR FIRE</b>	<b>50 to 54 STC SOUND</b>
<b>GYPSUM WALLBOARD, STEEL STUDS</b>			
<p>One layer 1/2" proprietary type X gypsum wallboard or gypsum veneer base applied at right angles to ONE SIDE of 2 1/2" steel studs 24" o.c. with 1" Type S drywall screws 8" o.c. at vertical joints and 12" o.c. at intermediate studs and wall perimeter.</p> <p>OPPOSITE SIDE: <b>Base</b> layer 1/2" proprietary type X gypsum wallboard or gypsum veneer base applied at right angles to studs with 1" Type S drywall screws 12" o.c. <b>Face</b> layer 1/2" proprietary type X gypsum wallboard or gypsum veneer base applied at right angles to studs with 1 5/16" Type S drywall screws 8" o.c. at vertical joints and 12" o.c. at intermediate studs and wall perimeter.</p> <p>Joints staggered 24" each layer and side. Sound tested with 3" glass fiber insulation friction fit in stud space. <b>(NLB)</b></p>			
<b>PROPRIETARY GYPSUM BOARD</b>			
<p>National Gypsum Company - 1/2" Gold Bond® Brand FIRE-SHIELD C™ Gypsum Board</p>			

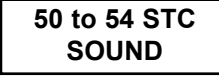
\*Contact the manufacturer for more detailed information on proprietary products.

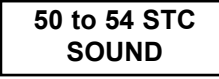
**WALLS AND INTERIOR PARTITIONS, NONCOMBUSTIBLE**

GA FILE NO. WP 1023	PROPRIETARY*	1 HOUR FIRE	50 to 54 STC SOUND									
<p align="center"><b>GYPSUM WALLBOARD, STEEL STUDS, GLASS FIBER INSULATION</b></p> <p>One layer 1/2" proprietary type X gypsum wallboard applied at right angles to ONE SIDE of 3/8" steel studs 24" o.c. with 1" Type S drywall screws 8" o.c. at vertical joints and 12" o.c. at intermediate studs. Studs attached to floor and ceiling runners with Type S pan head screws. 2 3/4" glass fiber insulation, 0.30 pcf, friction fit in stud space.</p> <p>OPPOSITE SIDE: <b>Base</b> layer 1/2" proprietary type X gypsum wallboard applied at right angles to studs with 1" Type S drywall screws 24" o.c. <b>Face</b> layer 1/2" proprietary type X gypsum wallboard applied at right angles to studs with 1 5/8" Type S drywall screws 8" o.c. at vertical joints and 12" o.c. at intermediate studs and wall perimeter. <b>Face</b> layer may include a 12" wide filler strip at midheight.</p> <p>Vertical joints staggered 24" each layer and side. Horizontal joints staggered 24" each layer and side, or minimum 12" when filler strip is used. <b>(NLB)</b></p> <p align="center"><b>PROPRIETARY GYPSUM BOARD</b></p> <table border="0"> <tr> <td>American Gypsum Company LLC</td> <td>-</td> <td>1/2" FireBloc® Type C</td> </tr> <tr> <td>Georgia-Pacific Gypsum LLC</td> <td>-</td> <td>1/2" ToughRock® Fireguard C™</td> </tr> <tr> <td>Temple-Inland</td> <td>-</td> <td>1/2" TG-C</td> </tr> </table>		American Gypsum Company LLC	-	1/2" FireBloc® Type C	Georgia-Pacific Gypsum LLC	-	1/2" ToughRock® Fireguard C™	Temple-Inland	-	1/2" TG-C		
American Gypsum Company LLC	-	1/2" FireBloc® Type C										
Georgia-Pacific Gypsum LLC	-	1/2" ToughRock® Fireguard C™										
Temple-Inland	-	1/2" TG-C										
<p align="center"><b>GYPSUM WALLBOARD, FIBER-CEMENT BOARD, STEEL STUDS</b></p> <p><b>Base</b> layer 1/2" proprietary type X gypsum wallboard applied parallel or at right angles to each side of 3/8" 20 gage steel studs 24" o.c. with 1" Type S-12 drywall screws 24" o.c. <b>Face</b> layer 1/4" proprietary fiber-cement board applied parallel or at right angles to studs with 1 5/8" No. 8 ribbed bugle head screws, 0.323" heads, 8" o.c. Joints offset 24" from base layer joints. Face layer joints taped and finished.</p> <p>Joints staggered 24" on opposite sides. <b>(NLB)</b></p> <p align="center"><b>PROPRIETARY GYPSUM BOARD</b></p> <table border="0"> <tr> <td>CertainTeed Gypsum Inc.</td> <td>-</td> <td>1/2" ProRoc® Type C Gypsum Panels</td> </tr> </table>		CertainTeed Gypsum Inc.	-	1/2" ProRoc® Type C Gypsum Panels								
CertainTeed Gypsum Inc.	-	1/2" ProRoc® Type C Gypsum Panels										
<p align="center"><b>GYPSUM WALLBOARD, PROPRIETARY STEEL STUDS</b></p> <p>One layer 5/8" proprietary type X gypsum wallboard applied parallel to each side of 3/8" proprietary steel studs 24" o.c. with 1 1/4" Type S drywall screws 8" o.c. at vertical joints and wall perimeter and 12" o.c. at intermediate studs.</p> <p>Joints staggered 24" on each side and on opposite sides.</p> <p>Sound tested with horizontal resilient furring channels 24" o.c. and 3 5/8" glass fiber insulation friction fit in stud space. <b>(NLB)</b></p> <p align="center"><b>PROPRIETARY GYPSUM BOARD</b></p> <table border="0"> <tr> <td>National Gypsum Company</td> <td>-</td> <td>5/8" Gold Bond® Brand FIRE-SHIELD® Gypsum Board</td> </tr> </table>		National Gypsum Company	-	5/8" Gold Bond® Brand FIRE-SHIELD® Gypsum Board								
National Gypsum Company	-	5/8" Gold Bond® Brand FIRE-SHIELD® Gypsum Board										

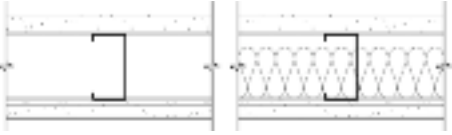
\*Contact the manufacturer for more detailed information on proprietary products.

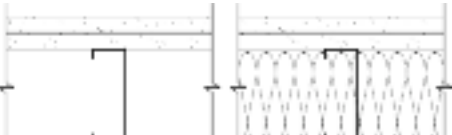
<b>WALLS AND INTERIOR PARTITIONS, NONCOMBUSTIBLE</b>																				
<b>GA FILE NO. WP 1050</b>	<b>PROPRIETARY*</b>	<b>1 HOUR FIRE</b>	<b>50 to 54 STC SOUND</b>																	
<p style="text-align: center;"><b>GYPSUM WALLBOARD, STEEL STUDS</b></p> <p><b>Base</b> layer 1/4" proprietary gypsum wallboard applied parallel to each side of 2 1/2" steel studs 24" o.c. with 1" Type S drywall screws 12" o.c. <b>Face</b> layer 1/2" proprietary type X plain or predecorated gypsum wallboard or gypsum veneer base applied parallel to each side with 3/4" beads of laminating compound 12" o.c. to full field of face layer and 1 3/8" Type S drywall screws 8" o.c. at floor and ceiling runners only.</p> <p>Joints staggered 24" each layer and side. Sound tested with 2" glass fiber insulation friction fit in stud space. <b>(NLB)</b></p> <p style="text-align: center;"><b>PROPRIETARY GYPSUM BOARD</b></p> <table border="0"> <tr> <td>Georgia-Pacific Gypsum LLC</td> <td>-</td> <td>1/4" ToughRock® Sound Deadening Board</td> </tr> <tr> <td></td> <td>-</td> <td>1/2" ToughRock® Fireguard C™</td> </tr> <tr> <td>Lafarge North America Inc.</td> <td>-</td> <td>1/4" Soundcheck®</td> </tr> <tr> <td></td> <td>-</td> <td>1/2" Firecheck® Type C</td> </tr> <tr> <td>Temple-Inland</td> <td>-</td> <td>1/4" Temple-4 Sound Deadening Board</td> </tr> <tr> <td></td> <td>-</td> <td>1/2" TG-C</td> </tr> </table>		Georgia-Pacific Gypsum LLC	-	1/4" ToughRock® Sound Deadening Board		-	1/2" ToughRock® Fireguard C™	Lafarge North America Inc.	-	1/4" Soundcheck®		-	1/2" Firecheck® Type C	Temple-Inland	-	1/4" Temple-4 Sound Deadening Board		-	1/2" TG-C	 <p>Thickness: 4"                  Approx. Weight: 7 psf                  Fire Test: UL R2717-53, 54; 9-4-68, UL Design U410;                  ULC Design W400                  Sound Test: G&amp;H BW-17FT, 8-8-66</p>
Georgia-Pacific Gypsum LLC	-	1/4" ToughRock® Sound Deadening Board																		
	-	1/2" ToughRock® Fireguard C™																		
Lafarge North America Inc.	-	1/4" Soundcheck®																		
	-	1/2" Firecheck® Type C																		
Temple-Inland	-	1/4" Temple-4 Sound Deadening Board																		
	-	1/2" TG-C																		
<b>GA FILE NO. WP 1051</b>	<b>GENERIC</b>	<b>1 HOUR FIRE</b>	<b>50 to 54 STC SOUND</b>																	
<p style="text-align: center;"><b>GYPSUM WALLBOARD, STEEL STUDS</b></p> <p><b>Base</b> layer 1/4" gypsum wallboard applied parallel to each side of 2 1/2" steel studs 24" o.c. with 1" Type S drywall screws 12" o.c. <b>Face</b> layer 1/2" type X gypsum wallboard or gypsum veneer base applied parallel to each side with 1/4" beads of laminating compound 2" o.c. to full field of face layer and 1 5/8" Type S drywall screws 8" o.c. at floor and ceiling runners only.</p> <p>Joints staggered 24" each layer and side. Sound tested with 2" glass fiber insulation friction fit in stud space and face layers screw attached without adhesive. <b>(NLB)</b></p>		 <p>Thickness: 4"                  Approx. Weight: 7 psf                  Fire Test: FM WP 152-1, 1-22-69                  Sound Test: NGC 2318, 8-19-68</p>																		
<b>GA FILE NO. WP 1052</b>	<b>GENERIC</b>	<b>1 HOUR FIRE</b>	<b>50 to 54 STC SOUND</b>																	
<p style="text-align: center;"><b>GYPSUM WALLBOARD, STEEL STUDS</b></p> <p>One layer 5/8" type X gypsum wallboard or gypsum veneer base applied parallel or at right angles to each side of 3 5/8" steel studs 24" o.c. with 1" Type S drywall screws 8" o.c. at vertical joints and 12" o.c. at wall perimeter and intermediate studs. <b>Face</b> layer 5/8" type X gypsum wallboard or gypsum veneer base applied parallel or at right angles to ONE SIDE with 1 5/8" Type S drywall screws 12" o.c.</p> <p>Joints staggered 24" each layer and side. Sound tested with 3 1/2" glass fiber friction fit in stud space. <b>(NLB)</b></p>		 <p>Thickness: 5 1/2"                  Approx. Weight: 8 psf                  Fire Test: See WP 1350                  (FM WP-45, 6-19-68; OSU T-1770, 8-61; ULC 79T484, 79T500, 79T497, 8-21-81, ULC Design W415)                  Sound Test: NRCC 817-NV, 2-3-81</p>																		

\*Contact the manufacturer for more detailed information on proprietary products.

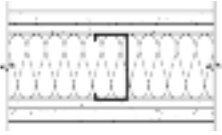
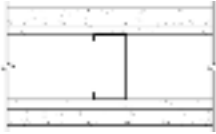
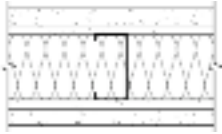
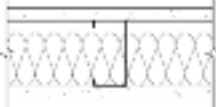
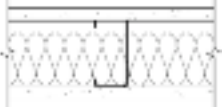
WALLS AND INTERIOR PARTITIONS, NONCOMBUSTIBLE			
GA FILE NO. WP 1053	GENERIC	1 HOUR FIRE	50 to 54 STC SOUND
<p align="center"><b>GYPSUM WALLBOARD, STEEL STUDS</b></p> <p><b>Base</b> layer 3/8" square edge regular gypsum wallboard or backing board applied parallel to each side of 2 1/2" steel studs 24" o.c. with 1" Type S drywall screws 12" o.c. <b>Face</b> layer 1/2" type X plain or predecorated gypsum wallboard or gypsum veneer base applied parallel to each side with 3/4" wide beads of laminating compound 12" o.c. to full field of face layer and 1 3/8" Type S drywall screws 8" o.c. at floor and ceiling runners only.</p> <p>Joints staggered 24" each layer and side. Sound tested with 3 1/2" glass fiber insulation friction fit in stud space. <b>(NLB)</b></p>			
		Thickness: 4 1/4" Approx. Weight: 7 psf Fire Test: ULC 74T184, 4-10-75, ULC Design W402 Sound Test: CK 8104.02, 2-3-81	
GA FILE NO. WP 1055	PROPRIETARY	1 HOUR FIRE	50 to 54 STC SOUND
<p align="center"><b>GYPSUM WALLBOARD, STEEL STUDS</b></p> <p><b>Base</b> layer 3/8" square edge regular gypsum wallboard or backing board applied parallel to each side of 2 1/2" steel studs 24" o.c. with 1" Type S drywall screws 12" o.c. <b>Face</b> layer 5/8" proprietary type X plain or predecorated gypsum wallboard or gypsum veneer base applied parallel or at right angles to each side with laminating compound and 1 1/4" Type S drywall screws 8" o.c. at floor and ceiling runners only.</p> <p>Horizontal joints on opposite sides need not be staggered or backed. Sound tested with 3 1/2" glass fiber insulation friction fit in stud space. <b>(NLB)</b></p> <p align="center"><b>PROPRIETARY GYPSUM BOARD</b></p> <p>CertainTeed Gypsum Canada Inc. - 5/8" ProRoc® Type X Gypsum Panels</p>			
		Thickness: 4 1/2" Approx. Weight: 7 psf Fire Test: UL R3660, 07NK21428, 2-14-08, ULC Design W402 Sound Test: CK 8104.02, 2-3-81	
GA FILE NO. WP 1070	GENERIC	1 HOUR FIRE	45 to 49 STC SOUND
<p align="center"><b>GYPSUM WALLBOARD, STEEL STUDS, MINERAL FIBER INSULATION</b></p> <p>One layer 1/2" type X gypsum wallboard or gypsum veneer base applied parallel to each side of 2 1/2" steel studs 24" o.c. with 1" Type S drywall screws 8" o.c. at vertical joints and 12" o.c. at intermediate studs. 2" mineral fiber insulation, 2.5 pcf, friction fit in stud space. Also fire tested with 1 1/2" mineral fiber insulation, 3.0 pcf, stapled to board in stud space.</p> <p>Joints staggered 24" on opposite sides. <b>(NLB)</b></p>			
		Thickness: 3 1/2" Approx. Weight: 5 psf Fire Test: FM WP 51-1, 9-22-66; OSU T-3362, 11-23-65 Sound Test: RAL TL69-42, 10-17-68	

\*Contact the manufacturer for more detailed information on proprietary products.

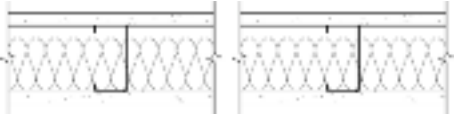
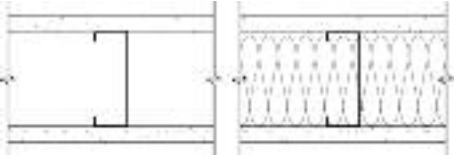
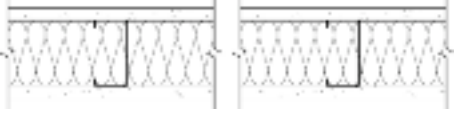
<b>WALLS AND INTERIOR PARTITIONS, NONCOMBUSTIBLE</b>			
<b>GA FILE NO. WP 1071</b>	<b>PROPRIETARY*</b>	<b>1 HOUR FIRE</b>	<b>45 to 49 STC SOUND</b>
<p style="text-align: center;"><b>GYPSUM WALLBOARD, STEEL STUDS, MINERAL FIBER INSULATION</b></p> <p>One layer 1/2" proprietary type X gypsum wallboard or gypsum veneer base applied at right angles to each side of 2 1/2" steel studs 24" o.c. with 1" Type S drywall screws 8" o.c. at vertical joints and 12" o.c. at intermediate studs and wall perimeter. 2" mineral fiber insulation, 3.0 pcf, friction fit in stud space.</p> <p>Vertical joints staggered 24" on each side and on opposite sides. Horizontal joints need not be staggered. <b>(NLB)</b></p> <p style="text-align: center;"><b>PROPRIETARY GYPSUM BOARD</b> National Gypsum Company - 1/2" Gold Bond® Brand FIRE-SHIELD C™ Gypsum Board</p>		 <p>Thickness: 3 1/2" Approx. Weight: 5 psf Fire Test: UL R3501, 93NK22748, 9-15-93, UL Design V401; FM WP-731, 9-12-84 Sound Test: See WP 1070 (RAL TL69-42, 10-17-68)</p>	
<b>GA FILE NO. WP 1072</b>	<b>GENERIC</b>	<b>1 HOUR FIRE</b>	<b>45 to 49 STC SOUND</b>
<p style="text-align: center;"><b>GYPSUM WALLBOARD, STEEL STUDS</b></p> <p>One layer 5/8" type X gypsum wallboard or gypsum veneer base applied parallel or at right angles to each side of 3 5/8" steel studs 24" o.c. with 1" Type S drywall screws 8" o.c. at vertical joints and 12" o.c. at floor and ceiling runners and intermediate studs.</p> <p>Joints staggered 24" on each side and on opposite sides. Sound tested with 3 1/2" glass fiber friction fit in stud space. <b>(NLB)</b></p>		 <p>Thickness: 4 7/8" Approx. Weight: 6 psf Fire Test: See WP 1350 (FM WP-45, 6-19-68; OSU T-1770, 8-61; ULC 79T484, 79T500, 79T497, 8-12-81, ULC Design W415) Sound Test: NRCC 816-NV, 2-3-81</p>	
<b>GA FILE NO. WP 1073</b>	<b>PROPRIETARY*</b>	<b>1 HOUR FIRE</b>	<b>45 to 49 STC SOUND</b>
<p style="text-align: center;"><b>GLASS MAT GYPSUM SUBSTRATE, STEEL STUDS, GLASS FIBER INSULATION</b></p> <p>One layer 1/2" proprietary glass mat water-resistant gypsum backing board applied parallel to each side of 2 1/2" steel studs 16" o.c. with 1" Type S drywall screws 8" o.c. at vertical joints and 12" o.c. at intermediate studs and wall perimeter. 3 1/2" glass fiber insulation, 0.526 pcf, friction fit in stud space.</p> <p>Joints staggered 16" on opposite sides and covered with 10 x 10 mesh glass tape and tile adhesive. <b>(NLB)</b></p> <p style="text-align: center;"><b>PROPRIETARY GYPSUM PANEL PRODUCT</b> Georgia-Pacific Gypsum LLC - 1/2" DensShield®</p>		 <p>Thickness: 3 1/2" Approx. Weight: 5 psf Fire Test: CTC 1897-1655, 1-11-88 Sound Test: See WP 1070 (RAL TL69-42, 10-17-68)</p>	

\*Contact the manufacturer for more detailed information on proprietary products.

**WALLS AND INTERIOR PARTITIONS, NONCOMBUSTIBLE**

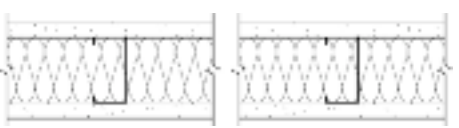
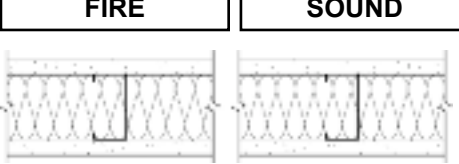
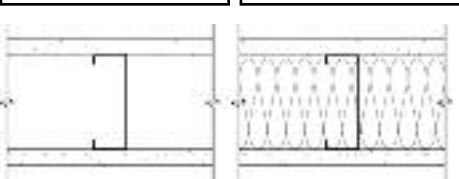
GA FILE NO. WP 1076	PROPRIETARY*	1 HOUR FIRE	45 to 49 STC SOUND
<p align="center"><b>GYPSUM WALLBOARD, STEEL STUDS, GLASS FIBER INSULATION</b></p> <p>One layer 5/8" proprietary type X gypsum wallboard or gypsum veneer base applied parallel to each side of 2 1/2" steel studs 24" o.c. with 1 1/4" Type S drywall screws 8" o.c. at wall perimeter and 12" o.c. at vertical joints and with 1 1/4" Type S drywall screws 12" o.c. or continuous 1/4" beads of adhesive at intermediate studs. 2 3/4" glass fiber insulation, 0.65 pcf, friction fit in stud space.</p> <p>Joints staggered 24" on opposite sides. (NLB)</p> <p align="center"><b>PROPRIETARY GYPSUM BOARD</b></p> <p>CertainTeed Gypsum Canada Inc. - 5/8" ProRoc® Type X Gypsum Panels Georgia-Pacific Gypsum LLC - 5/8" ToughRock® Fireguard®</p>		 <p>Thickness: 3 3/4" Approx. Weight: 6 psf Fire Test: ULC 78T55, 1-9-79, ULC Design W409 Sound Test: DRC 70-2-2, 1-6-70</p>	
GA FILE NO. WP 1077	PROPRIETARY*	1 HOUR FIRE	45 to 49 STC SOUND
<p align="center"><b>GYPSUM WALLBOARD, STEEL STUDS, GLASS FIBER INSULATION</b></p> <p>One layer 5/8" proprietary type X gypsum wallboard or gypsum veneer base applied parallel to each side of 2 1/2" steel studs 24" o.c. with 1 1/4" Type S drywall screws 8" o.c. Glass fiber insulation, 2 3/4", 0.65 pcf, friction fit in stud space.</p> <p>Horizontal joints on opposite sides need not be staggered or backed. (NLB)</p> <p align="center"><b>PROPRIETARY GYPSUM BOARD</b></p> <p>CertainTeed Gypsum Canada Inc. - 5/8" ProRoc® Type X Gypsum Panels</p>		 <p>Thickness: 3 3/4" Approx. Weight: 6 psf Fire Test: UL R15187, 07NK21428 2-14-08, ULC Design W409 Sound Test: DRC 70-2-2, 1-6-70</p>	
GA FILE NO. WP 1078	PROPRIETARY*	1 HOUR FIRE	45 to 49 STC SOUND
<p align="center"><b>GYPSUM WALLBOARD, STEEL STUDS</b></p> <p>One layer 5/8" proprietary type X gypsum wallboard applied parallel to each side of 3 5/8" steel studs 24" o.c. with 1" Type S drywall screws 8" o.c. at studs and 12" o.c. at floor runners.</p> <p>Horizontal edge and butt joints on opposite sides of studs need not be staggered. Sound tested with 3" glass fiber insulation friction fit in stud space. (NLB)</p> <p align="center"><b>PROPRIETARY GYPSUM BOARD</b></p> <p>National Gypsum Company - 5/8" Gold Bond® Brand FIRE-SHIELD® Gypsum Board</p>		 <p>Thickness: 4 7/8" Approx. Weight: 6 psf Fire Test: UL R3501, 08NK09662 6-19-08, UL Design V438 Sound Test: NGC 2386, 8-4-70</p>	

\*Contact the manufacturer for more detailed information on proprietary products.

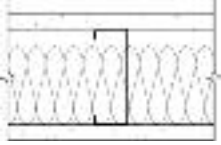
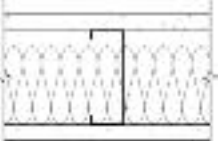
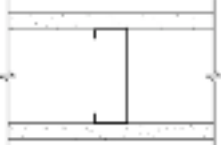
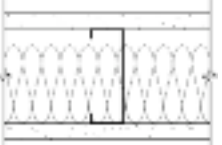
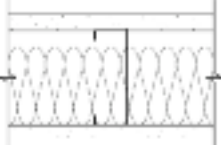
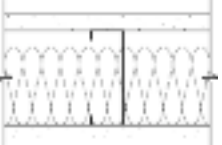
<b>WALLS AND INTERIOR PARTITIONS, NONCOMBUSTIBLE</b>			
<b>GA FILE NO. WP 1079</b>	<b>PROPRIETARY*</b>	<b>1 HOUR FIRE</b>	<b>45 to 49 STC SOUND</b>
<p style="text-align: center;"><b>GYPSUM WALLBOARD, STEEL STUDS, MINERAL FIBER INSULATION</b></p> <p>One layer 5/8" proprietary type X gypsum wallboard or gypsum veneer base applied parallel or at right angles to each side of 3 5/8" steel studs 24" o.c. with 1" Type S drywall screws 8" o.c. Mineral fiber insulation partially or completely filling stud space.</p> <p>Horizontal joints on opposite sides need not be staggered or backed. <b>(NLB)</b></p> <p style="text-align: center;"><b>PROPRIETARY GYPSUM BOARD</b></p> <p>CertainTeed Gypsum Inc. - 5/8" ProRoc® Type X Gypsum Panels</p>		 	<p>Thickness: 47/8"</p> <p>Approx. Weight: 5 psf</p> <p>Fire Test: UL R15187, 07NK21428 2-14-08, UL Design V417</p> <p>Sound Test: NGC 2006048, 1-31-07</p>
<b>GA FILE NO. WP 1081</b>	<b>PROPRIETARY*</b>	<b>1 HOUR FIRE</b>	<b>45 to 49 STC SOUND</b>
<p style="text-align: center;"><b>GYPSUM PANEL PRODUCTS, STEEL STUDS</b></p> <p>One layer 5/8" proprietary type X gypsum wallboard or glass mat gypsum substrate applied parallel to each side of 3 5/8" steel studs 24" o.c. with 1" Type S drywall screws 8" o.c. at vertical joints and 12" o.c. at floor and ceiling runners and intermediate studs. Optional horizontal resilient channel 24" o.c applied to studs with one 1/2" Type S-12 pan head screw at each stud intersection.</p> <p>Stagger joints 24" on opposite sides. Sound tested with 3" mineral fiber, 2.5 pcf, in stud space. <b>(NLB)</b></p> <p style="text-align: center;"><b>PROPRIETARY GYPSUM PANEL PRODUCTS</b></p> <p>American Gypsum Company LLC - 5/8" FireBloc® Type X                      CertainTeed Gypsum Canada Inc. - 5/8" ProRoc® Type X Gypsum Panels                      CertainTeed Gypsum Inc. - 5/8" GlasRoc® Tilebacker Type X Gypsum Panels                      Georgia-Pacific Gypsum LLC - 5/8" ToughRock® Fireguard®                      Lafarge North America Inc. - 5/8" Firecheck® Type X                      National Gypsum Company - 5/8" Gold Bond® Brand FIRE-SHIELD® Gypsum Board                      Temple-Inland - 5/8" Type X                      United States Gypsum Company - 5/8" SHEETROCK® Brand Abuse-Resistant FIRECODE® Core Gypsum Panels</p>		 	<p>Thickness: 47/8"</p> <p>Approx. Weight: 5 psf</p> <p>Fire Test: UL R1319, 94NK40598, 11-30-94; UL R3660, 07NK18571, 11-2-07; UL R15187, 02NK31412, 7-17-02; UL Design U465</p> <p>Sound Test: USG-960709, 7-18-96; RAL-TL99-103, 6-28-99; RAL-TL99-160, 9-3-99; NGC 2006048, 1-31-07</p>
<b>GA FILE NO. WP 1082</b>	<b>PROPRIETARY*</b>	<b>1 HOUR FIRE</b>	<b>45 to 49 STC SOUND</b>
<p style="text-align: center;"><b>GYPSUM WALLBOARD, STEEL STUDS, MINERAL FIBER INSULATION, CEMENTITIOUS BACKER UNIT</b></p> <p>One layer 5/8" proprietary type X gypsum wallboard or veneer base applied parallel to ONE SIDE of 3 5/8" 25 gage steel studs 16" o.c. with 1 1/4" Type S drywall screws 8" o.c. at vertical joints and 12" o.c. to intermediate studs. 3" mineral fiber insulation batts, 2.5 pcf, in stud space.</p> <p>OPPOSITE SIDE: One layer 1/2" proprietary cementitious backer units applied parallel or at right angles to studs with 1 1/4" Type S wafer head screws 8" o.c.</p> <p>Vertical joints staggered 16" on opposite sides. <b>(NLB)</b></p> <p style="text-align: center;"><b>PROPRIETARY GYPSUM BOARD</b></p> <p>National Gypsum Company - 5/8" Gold Bond® Brand FIRE-SHIELD® Gypsum Board</p>		 	<p>Thickness: 4 3/4"</p> <p>Approx. Weight: 6 psf</p> <p>Fire Test: ITS J99-04001, 11-16-98 &amp; 2-5-99, ITS Design NGC/WA 60-01; UL R22158, 05CA15728, 5-23-05, UL Design V452</p> <p>Sound Test: NGC 2099015, 8-19-99</p>

\*Contact the manufacturer for more detailed information on proprietary products.





WALLS AND INTERIOR PARTITIONS, NONCOMBUSTIBLE			
<p><b>GA FILE NO. WP 1083</b></p>	<p><b>PROPRIETARY*</b></p>	<p><b>1 HOUR FIRE</b></p>	<p><b>45 to 49 STC SOUND</b></p>
<p><b>GYPSUM PANEL PRODUCTS, STEEL STUDS</b></p>			
<p>One layer 5/8" proprietary type X gypsum wallboard, gypsum veneer base, or glass mat gypsum substrate applied at right angles to each side of 3 5/8" steel studs 24" o.c. with 1" Type S drywall screws 8" o.c.</p>		<p>Thickness: 47/8"                      Approx. Weight: 5 psf                      Fire Test: UL R3660, 07NK21428, 2-14-08, UL Design U465                      Sound Test: NGC 2006048, 1-31-07; RAL TL99-103, 6-28-99</p>	
<p>Horizontal joints on opposite sides need not be staggered or backed. Sound tested with 3 1/2" glass fiber insulation in stud space. <b>(NLB)</b></p>			
<p><b>PROPRIETARY GYPSUM PANEL PRODUCTS</b></p>			
<p>CertainTeed Gypsum Inc.</p>	<p>- 5/8" ProRoc® Type X Gypsum Panels</p>		
<p>Georgia-Pacific Gypsum LLC</p>	<p>- 5/8" DensArmor Plus® Fireguard® Interior Guard</p>		
<p><b>GA FILE NO. WP 1084</b></p>	<p><b>PROPRIETARY*</b></p>	<p><b>1 HOUR FIRE</b></p>	<p><b>45 to 49 STC SOUND</b></p>
<p><b>GYPSUM WALLBOARD, STEEL STUDS</b></p>			
<p>One layer 5/8" proprietary type X gypsum wallboard or gypsum veneer base applied at right angles to each side of 3 5/8" proprietary steel studs 24" o.c. with 1" Type S drywall screws 8" o.c.</p>		<p>Thickness: 47/8"                      Approx. Weight: 5 psf                      Fire Test: UL R3660, 07NK08880, 7-27-07, UL Design V450                      Sound Test: RAL-TL07-357, 11-7-07</p>	
<p>Horizontal joints on opposite sides need not be staggered or backed. Sound tested with 3 1/2" glass fiber insulation in stud space. <b>(NLB)</b></p>			
<p><b>PROPRIETARY GYPSUM BOARD</b></p>			
<p>CertainTeed Gypsum Inc.</p>	<p>- 5/8" ProRoc® Type X Gypsum Panels</p>		
<p><b>GA FILE NO. WP 1085</b></p>	<p><b>PROPRIETARY*</b></p>	<p><b>1 HOUR FIRE</b></p>	<p><b>45 to 49 STC SOUND</b></p>
<p><b>GYPSUM PLASTER, GYPSUM LATH, STEEL STUDS</b></p>			
<p>7/16" proprietary 1:2 gypsum-sand basecoat plaster and 1/16" lime gauging plaster finish applied over one layer 3/8" proprietary type X gypsum lath applied perpendicular to each side of 2 1/2" steel studs 16" o.c. with 1" Type S drywall screws 8" o.c.</p>		<p>Thickness: 4 1/4"                      Approx. Weight: 15 psf                      Fire Test: UL R1319, 12-12-90, UL Design U488                      Sound Test: CK 664-18, 4-6-66</p>	
<p>Sound tested with 1" mineral fiber insulation stapled to one side in stud space. <b>(NLB)</b></p>			
<p><b>PROPRIETARY GYPSUM LATH</b></p>			
<p>United States Gypsum Company</p>	<p>- 3/8" ROCKLATH® Plaster Base FIRECODE® Core</p>		

\*Contact the manufacturer for more detailed information on proprietary products.

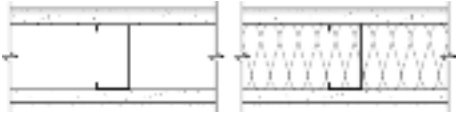
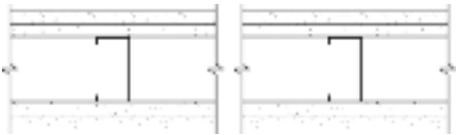
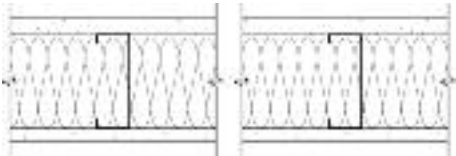
<b>WALLS AND INTERIOR PARTITIONS, NONCOMBUSTIBLE</b>				
<b>GA FILE NO. WP 1090</b>	<b>GENERIC</b>	<b>1 HOUR FIRE</b>	<b>45 to 49 FSTC SOUND</b>	
<b>GYPSUM WALLBOARD, STEEL STUDS</b>				
<p><b>Base</b> layer 1/4" gypsum wallboard applied parallel to each side of 15/8" steel studs 24" o.c. with 1" Type S drywall screws 24" o.c. at vertical joints and 36" o.c. at intermediate studs. <b>Face</b> layer 1/2" type X gypsum wallboard or gypsum veneer base applied parallel to each side with 15/8" Type S drywall screws 12" o.c.</p> <p>Joints staggered 24" each layer and side. <b>(NLB)</b></p>				
		<p>Thickness: 3 1/8"                      Approx. Weight: 7 psf                      Fire Test: UC, 12-28-65                      Field Sound Test: ACI 7-1152019c, 12-29-65</p>		
<b>GA FILE NO. WP 1204</b>	<b>GENERIC</b>	<b>1 HOUR FIRE</b>	<b>40 to 44 STC SOUND</b>	
<b>GYPSUM WALLBOARD, STEEL STUDS</b>				
<p><b>Base</b> layer 1/2" type X gypsum wallboard or gypsum veneer base applied parallel to each side of 3 1/2" 20 gage steel studs 24" o.c. with 15/8" Type S-12 drywall screws 12" o.c. <b>Face</b> layer 1/2" type X gypsum wallboard or gypsum veneer base applied parallel to each side with 15/8" Type S-12 drywall screws 12" o.c. Studs attached to each side of floor and ceiling runners by welding or with 1/2" Type S-12 pan head screws.</p> <p>Joints staggered 24" each layer and side.</p> <p><b>Bracing:</b> Lateral bracing spaced not over 40" o.c. shall be 1" by 18 gage steel straps attached to each side or channel bracing attached to each stud with a clip angle. For studs with holes or punch-outs in the web the "Q" factor shall be determined by means of stub column tests. Tested at 100 percent of design load. (Passed 90 minute fire test.) <b>(LOAD-BEARING)</b></p>				
		<p>Thickness: 5 1/2"                      Approx. Weight: 9 psf                      Fire Test: UL NC 505-1, 7-29-82, UL Design U425                      Sound Test: See WP 1615 (NGC 2250, 1-3-68)</p>		
<b>GA FILE NO. WP 1206</b>	<b>GENERIC</b>	<b>1 HOUR FIRE</b>	<b>40 to 44 STC SOUND</b>	
<b>GYPSUM WALLBOARD, STEEL STUDS</b>				
<p>One layer 5/8" type X gypsum wallboard or gypsum veneer base applied parallel to each side of 3 1/2" 20 gage steel studs 24" o.c. with 1" Type S-12 drywall screws 12" o.c. Studs attached to each side of floor and ceiling runners by welding or with 1/2" Type S-12 pan head screws.</p> <p>Joints staggered 24" on opposite sides.</p> <p><b>Bracing:</b> Lateral bracing spaced not over 40" o.c. shall be 1" by 18 gage steel straps attached to each side or channel bracing attached to each stud with a clip angle. For studs with holes or punch-outs in the web the "Q" factor shall be determined by means of stub column tests. Tested at 100 percent of design load. <b>(LOAD-BEARING)</b></p>				
		<p>Thickness: 4 3/4"                      Approx. Weight: 6 psf                      Fire Test: UL NC 505-2, 7-29-82, UL Design U425                      Sound Test: See WP 1350 (NGC 2385, 7-28-70)</p>		

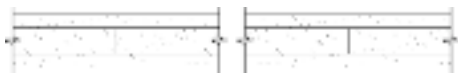

<b>WALLS AND INTERIOR PARTITIONS, NONCOMBUSTIBLE</b>				
<b>GA FILE NO. WP 1240</b>	<b>GENERIC</b>	<b>1 HOUR FIRE</b>	<b>40 to 44 STC SOUND</b>	
<b>GYPSUM VENEER PLASTER, GYPSUM VENEER BASE, STEEL STUDS</b>				
<p>One layer 1/2" type X gypsum veneer base applied parallel or at right angles to each side of 2 1/2" steel studs 24" o.c. with 1" Type S drywall screws 8" o.c. at vertical joints and 12" o.c. at intermediate studs. 1/16" gypsum veneer plaster applied over each side.</p> <p>Joints staggered 24" on each side and on opposite sides. Sound tested with 3" glass fiber insulation in stud space and with studs 16" o.c. <b>(NLB)</b></p>				
				Thickness: 3 5/8" Approx. Weight: 5 psf Fire Test: UC, 8-5-63; UC, 11-1-63; UC, 5-31-66 Sound Test: G&H NG-269FT, 12-20-65
<b>GA FILE NO. WP 1290</b>	<b>GENERIC</b>	<b>1 HOUR FIRE</b>	<b>40 to 44 STC SOUND</b>	
<b>GYPSUM PLASTER, GYPSUM LATH, STEEL STUDS</b>				
<p>1/2" 1:2 gypsum-sand plaster applied over 1/2" plain gypsum lath applied at right angles to each side of 2 1/2" steel studs 24" o.c. with 1" Type S screws, 3 per stud per lath width, or 12 gage wire clips. End joint clips at lath corners. <b>(NLB)</b></p>				
				Thickness: 4 1/2" Approx. Weight: 15 psf Fire Test: FM WP-53, 11-29-66 Sound Test: NGC 2061, 10-24-66
<b>GA FILE NO. WP 1296</b>	<b>PROPRIETARY*</b>	<b>1 HOUR FIRE</b>	<b>40 to 44 STC SOUND</b>	
<b>GYPSUM WALLBOARD, STEEL STUDS, MINERAL FIBER INSULATION, FIBER-CEMENT BOARD</b>				
<p>One layer 5/8" proprietary type X gypsum wallboard applied parallel to ONE SIDE of 3 5/8" steel studs 16" o.c. with 1" Type S drywall screws 8" o.c. at vertical joints and 12" o.c. at intermediate studs. 3 1/2" mineral fiber insulation, 3.0 pcf, friction fit in stud space.</p> <p>OPPOSITE SIDE: One layer 7/16" proprietary fiber-cement board applied parallel to studs with 1" No. 8-18 x 0.323" head diameter ribbed bugle head screws 6" o.c. <b>(NLB)</b></p>				
<b>PROPRIETARY GYPSUM BOARD</b>				
CertainTeed Gypsum Inc. - 5/8" ProRoc® Type X Gypsum Panels				Thickness: 4 3/4" Approx. Weight: 7.5 psf Fire Test: OPL 11710-92783, 2-13-92 Sound Test: See WP 1350 (NGC 2385, 7-28-70)



\*Contact the manufacturer for more detailed information on proprietary products.

<b>WALLS AND INTERIOR PARTITIONS, NONCOMBUSTIBLE</b>			
<b>GA FILE NO. WP 1311</b>	<b>PROPRIETARY*</b>	<b>1 HOUR FIRE</b>	<b>35 to 39 STC SOUND</b>
<b>SOLID GYPSUM WALLBOARD</b>			
<p>One layer 1/2" regular gypsum wallboard or gypsum veneer base applied parallel to each side of 1" x 24" proprietary type X gypsum panels with laminating compound combed over the entire contact surface and 1 5/16" Type S screws 24" o.c. horizontally and vertically. 1" gypsum coreboard panels attached to 25 gage 1" x 2 1/4" high "L" runners along floor and ceiling lines with two 1 5/16" Type S screws at top and bottom. Wallboard layers attached to "L" runners with 1 7/8" Type S screws 12" o.c.</p> <p>Joints staggered 12" each layer and side. <b>(NLB)</b></p> <p style="text-align: center;"><b>PROPRIETARY GYPSUM BOARD</b></p> <p>National Gypsum Company - 1" Gold Bond® Brand FIRE-SHIELD® Shaftliner</p>		<p>Thickness: 2"                      Limiting Height: 11'0"                      Approx. Weight: 8 psf                      Fire Test: FM WP-671, 6-28-82                      Sound Test: Based on NGC 2359, 11-18-69</p>	
<b>GA FILE NO. WP 1330</b>	<b>GENERIC</b>	<b>1 HOUR FIRE</b>	<b>35 to 39 STC SOUND</b>
<b>SEMI-SOLID GYPSUM WALLBOARD, GYPSUM STUDS</b>			
<p>One layer 5/8" type X gypsum wallboard or gypsum veneer base applied parallel to each side of 6" wide gypsum studs 24" o.c. with 1" Type G drywall screws 20" o.c. and with laminating compound. Gypsum studs fabricated from 2 or 3 layers of 1/2" or 5/8" laminated gypsum panels. Fire tested with 1" thick gypsum studs.</p> <p>Sound tested with 5/8" thick gypsum studs. <b>(NLB)</b></p>		<p>Thickness: Varies                      Limiting Height: 12'0"                      Approx. Weight: 8 psf                      Fire Test: UL R2717-19, -21, 6-3-57, UL Design U510; ULC Design W502                      Sound Test: Based on G&amp;H BW-8FT, 8-1-62</p>	
<b>GA FILE NO. WP 1340</b>	<b>GENERIC</b>	<b>1 HOUR FIRE</b>	<b>35 to 39 STC SOUND</b>
<b>GYPSUM WALLBOARD, STEEL STUDS</b>			
<p>One layer 5/8" type X gypsum wallboard or gypsum veneer base applied parallel to each side of 1 5/8" steel studs 24" o.c. with 1" Type S drywall screws 8" o.c. at edges and 12" o.c. at intermediate studs.</p> <p>Joints staggered 24" on opposite sides. <b>(NLB)</b></p>		<p>Thickness: 2 7/8"                      Approx. Weight: 6 psf                      Fire Test: OSU T-3296, 10-1-65                      Sound Test: RAL TL64-244, 5-8-64</p>	

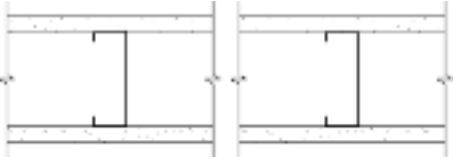
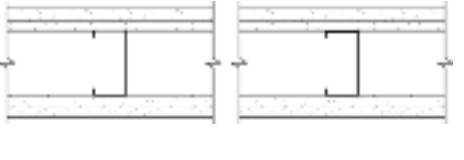
\*Contact the manufacturer for more detailed information on proprietary products.

**WALLS AND INTERIOR PARTITIONS, NONCOMBUSTIBLE**

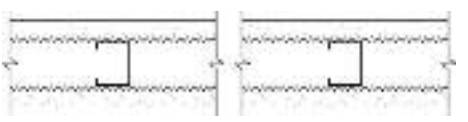
GA FILE NO. WP 1350	GENERIC	1 HOUR FIRE	35 to 39 STC SOUND
<b>GYPSUM WALLBOARD, STEEL STUDS</b>			
One layer 5/8" type X gypsum wallboard or gypsum veneer base applied parallel or at right angles to each side of 35/8" steel studs 24" o.c. with 1" Type S drywall screws 8" o.c. at vertical joints and 12" o.c. at floor and ceiling runners and intermediate studs.			
Joints staggered 24" on opposite sides. (NLB)			
		Thickness: 47/8" Approx. Weight: 6 psf Fire Test: FM WP-45, 6-19-68; OSU T-1770, 8-61; ULC 79T484, 79T500, 79T497, 8-12-81, ULC Design W415 Sound Test: NGC 2005004, 6-15-05 RAL TL06-114, 4-11-06	
GA FILE NO. WP 1370	GENERIC	1 HOUR FIRE	35 to 39 STC SOUND
<b>GYPSUM PLASTER, GYPSUM LATH, STEEL STUDS</b>			
1/2" 1:2 gypsum-sand plaster applied over 3/8" type X gypsum lath applied at right angles to each side of 21/2" steel studs 24" o.c. with two 1" Type S drywall screws at each stud and two butt joint clips per lath at lath ends. (NLB)			
		Thickness: 41/4" Approx. Weight: 14 psf Fire Test: UC, 12-21-65 Sound Test: RAL TL63-268, 6-4-63	
GA FILE NO. WP 1380	GENERIC	1 HOUR FIRE	35 to 39 STC SOUND
<b>SOLID GYPSUM PLASTER, METAL LATH, METAL CHANNEL</b>			
2" solid 1:11/2 gypsum-sand plaster applied over 2.5 lb. metal lath wire tied 6" o.c. to one side of 3/4" cold rolled channel studs 16" o.c. embedded in the plaster. (NLB)			
		Thickness: 2" Limiting Height: 12'6" Approx. Weight: 18 psf Fire Test: OSU T-129, 3-16-48 Sound Test: BMS 144/523, 2-25-55; NBS Monograph 77, 11-30-64	

WALLS AND INTERIOR PARTITIONS, NONCOMBUSTIBLE				
GA FILE NO. WP 1390	GENERIC	1 HOUR FIRE	35 to 39 STC SOUND	
<p align="center"><b>SOLID GYPSUM PLASTER, METAL LATH</b></p>				
<p>1" 1:2 gypsum-sand plaster applied over each side of 3/8" rib metal lath to form 2" solid studless wall. (NLB)</p>		<p>Thickness: 2"                      Limiting Height: 10'0"                      Approx. Weight: 18 psf                      Fire Test: OSU T-162, 4-26-51                      Sound Test: BMS 144/527, 2-25-55;                      NBS Monograph 77, 11-30-64</p>		
GA FILE NO. WP 1400	GENERIC	1 HOUR FIRE	35 to 39 STC SOUND	
<p align="center"><b>GYPSUM PLASTER, METAL LATH, STEEL STUDS</b></p>				
<p>5/8" 1:2-1:3 gypsum-sand plaster applied over 3.4 lb. metal lath wire tied 6" o.c. to each side of 1 5/8" open or punched web steel studs 16" o.c. (NLB)</p>		<p>Thickness: 3 1/8"                      Approx. Weight: 18 psf                      Fire Test: OSU T-1511, 9-23-60                      Sound Test: RAL TL61-2, 9-8-60</p>		
GA FILE NO. WP 1411	PROPRIETARY*	1 HOUR FIRE		
<p align="center"><b>GYPSUM PANEL PRODUCTS, STEEL STUDS</b></p>				
<p>One layer 5/8" proprietary type X gypsum wallboard or gypsum panels applied parallel to each side of 3 5/8" proprietary steel studs 24" o.c. with 1" Type S drywall screws 8" o.c. at vertical joints and at wall perimeter and 12" o.c. at intermediate studs.</p>		<p>Thickness: 4 7/8"                      Approx. Weight: 5 psf                      Fire Test: UL R14196, 07NK11544, 8-6-07, UL Design V450</p>		
<p>Joints staggered 24" on opposite sides. (NLB)</p>				
<p align="center"><b>PROPRIETARY GYPSUM PANEL PRODUCTS</b></p>				
<p>American Gypsum Company LLC</p>	-	5/8" FireBloc® Type X		
<p>Georgia-Pacific Gypsum LLC</p>	-	5/8" DensArmor Plus® Fireguard® Interior Guard		
<p>Lafarge North America Inc.</p>	-	5/8" Firecheck® Type X		

\*Contact the manufacturer for more detailed information on proprietary products.

**WALLS AND INTERIOR PARTITIONS, NONCOMBUSTIBLE**

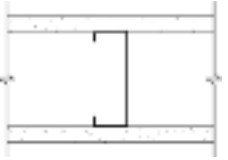
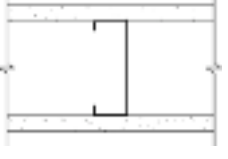
GA FILE NO. WP 1412	PROPRIETARY*	1 HOUR FIRE
<p align="center"><b>GYPSUM PANEL PRODUCTS, RESILIENT CHANNELS, STEEL STUDS</b></p> <p>Resilient channels 16" o.c. attached at right angles to ONE SIDE of 3<sup>5</sup>/<sub>8</sub>" proprietary steel studs 24" o.c. with 1/2" Type S-12 drywall screws. One layer 5/8" proprietary type X gypsum wallboard or gypsum panels applied at right angles to channels with 1" Type S drywall screws 8" o.c. at horizontal joints and at wall perimeter and 12" o.c. at intermediate channels.</p> <p>OPPOSITE SIDE: One layer 5/8" proprietary type X gypsum wallboard or gypsum panels applied at right angles to studs with 1" Type S drywall screws 8" o.c. at vertical joints and at wall perimeter and 12" o.c. at intermediate studs.</p> <p>Vertical joints staggered 24" on opposite sides. <b>(NLB)</b></p> <p align="center"><b>PROPRIETARY GYPSUM PANEL PRODUCTS</b></p> <p>American Gypsum Company LLC - 5/8" FireBloc® Type X          Georgia-Pacific Gypsum LLC - 5/8" DensArmor Plus® Fireguard® Interior Guard</p>		<p>Thickness: 4<sup>7</sup>/<sub>8</sub>"          Approx. Weight: 5 psf          Fire Test: UL R14196, 07NK11544, 8-6-07, UL Design V450</p>
GA FILE NO. WP 1413	PROPRIETARY*	1 HOUR FIRE
<p align="center"><b>GYPSUM WALLBOARD, STEEL STUDS</b></p> <p>One layer 5/8" proprietary type X gypsum wallboard or gypsum veneer base applied parallel or at right angles to each side of 3<sup>1</sup>/<sub>2</sub>", 25 gauge steel studs 24" o.c. with 1" Type S drywall screws 8" o.c. at edges and 12" o.c. at intermediate studs when applied parallel to framing or 8" o.c. at ends and at intermediate studs when applied at right angles to framing.</p> <p>Vertical joints centered over studs and staggered one stud cavity on opposite sides. Horizontal joints on opposite sides need not be staggered or backed. <b>(NLB)</b></p> <p align="center"><b>PROPRIETARY GYPSUM BOARD</b></p> <p>United States Gypsum Company - 5/8" SHEETROCK® Brand FIRECODE® Core Gypsum Panels</p>		<p>Thickness: 4<sup>3</sup>/<sub>4</sub>"          Approx. Weight: 7 psf          Fire Test: UL R1319, 05NK17682, 8-22-05, UL Design U419</p>
GA FILE NO. WP 1414	PROPRIETARY*	1 HOUR FIRE
<p align="center"><b>GYPSUM WALLBOARD, STEEL STUDS</b></p> <p>One layer 5/8" proprietary type X gypsum wallboard or gypsum veneer base applied parallel or at right angles to each side of 3<sup>5</sup>/<sub>8</sub>" proprietary steel studs 24" o.c. with 1" Type S drywall screws 8" o.c.</p> <p>Horizontal joints on opposite sides need not be staggered or backed. <b>(NLB)</b></p> <p align="center"><b>PROPRIETARY GYPSUM BOARD</b></p> <p>United States Gypsum Company - 5/8" SHEETROCK® Brand FIRECODE® Core Gypsum Panels</p>		<p>Thickness: 4<sup>7</sup>/<sub>8</sub>"          Approx. Weight: 7 psf          Fire Test: UL R1319, 05NK17682, 8-22-05, UL Design U419</p>

\*Contact the manufacturer for more detailed information on proprietary products.

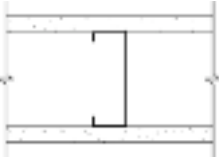
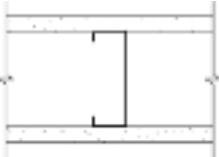
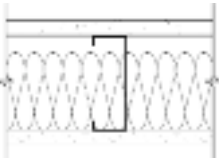
<b>WALLS AND INTERIOR PARTITIONS, NONCOMBUSTIBLE</b>			
<b>GA FILE NO. WP 1415</b>	<b>PROPRIETARY*</b>	<b>1 HOUR FIRE</b>	
<b>GYPSUM WALLBOARD, GLASS MAT GYPSUM SUBSTRATE, STEEL STUDS</b>			
<p>One layer 5/8" proprietary type X gypsum wallboard applied parallel to ONE SIDE of 35/8" steel studs 24" o.c. with 1" Type S drywall screws 8" o.c. at vertical joints and 12" o.c. at floor and ceiling runners and intermediate studs. Optional resilient channel (not shown) 24" o.c. applied to studs with one 1/2" Type S-12 pan head screw at each stud.</p> <p>OPPOSITE SIDE: One layer 5/8" proprietary type X glass mat gypsum substrate applied parallel to studs with 1" Type S drywall screws 8" o.c. at vertical joints and 12" o.c. at floor and ceiling runners and intermediate studs.</p> <p>Joints staggered 24" on opposite sides. <b>(NLB)</b></p>			<p>Thickness: 47/8"                  Approx. Weight: 6 psf                  Fire Test: UL R6937, 06NK17962, 2/19/08, UL Design U465</p>
<b>PROPRIETARY GYPSUM PANEL PRODUCTS</b>			
Temple-Inland	-		5/8" GreenGlass Type X 5/8" Type X
<b>GA FILE NO. WP 1416</b>	<b>PROPRIETARY*</b>	<b>1 HOUR FIRE</b>	
<b>GYPSUM WALLBOARD, STEEL STUDS</b>			
<p>One layer 5/8" proprietary type X gypsum wallboard or gypsum veneer base applied parallel to each side of 35/8" proprietary steel studs 24" o.c. with 11/4" Type S drywall screws 8" o.c. at vertical joints and 12" o.c. at floor and ceiling runners and intermediate studs.</p> <p>Joints staggered on opposite sides. <b>(NLB)</b></p>			<p>Thickness: 47/8"                  Approx. Weight: 7 psf                  Fire Test: WFCi 07024, 6-5-07; WFCi 08067, 9-12-08</p>
<b>PROPRIETARY GYPSUM BOARD</b>			
Temple-Inland	-		5/8" Type X
<b>GA FILE NO. WP 1417</b>	<b>PROPRIETARY*</b>	<b>1 HOUR FIRE</b>	
<b>GYPSUM WALLBOARD, STEEL STUDS, MINERAL FIBER INSULATION, CEMENTITIOUS BACKER UNIT</b>			
<p>One layer 5/8" proprietary type X gypsum wallboard or gypsum veneer base applied parallel or at right angles to ONE SIDE of 31/2" 20 gage steel studs 16" o.c. with 1" Type S drywall screws 8" o.c. at vertical joints and 12" o.c. at intermediate studs. 3" mineral fiber insulation batts, 2 pcf, in stud space. For load-bearing, studs attached to each side of floor and ceiling runners by welding or with 1/2" Type S-12 pan head screws.</p> <p>OPPOSITE SIDE: One layer 1/2" proprietary cementitious backer units applied parallel or at right angles to studs with 11/4" Type S-12 wafer head screws 8" o.c. Joints staggered and covered with glass fiber mesh tape. <b>(LOAD-BEARING)</b></p>			<p>Thickness: 45/8"                  Approx. Weight: 7 psf                  Fire Test: UL R12262, 96NK4276, 5-1-96, UL Design U404</p>
<b>PROPRIETARY GYPSUM BOARD</b>			
United States Gypsum Company	-		5/8" SHEETROCK® Brand FIRECODE® Core Gypsum Panels

\*Contact the manufacturer for more detailed information on proprietary products.

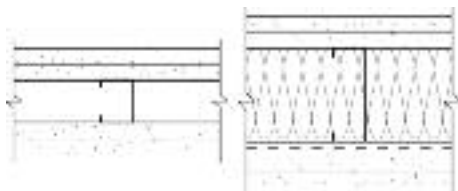
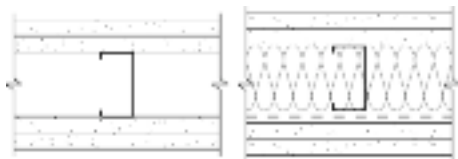
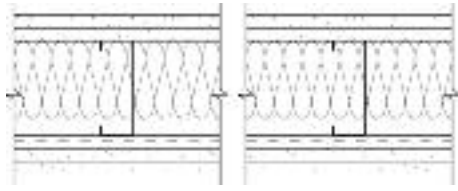

WALLS AND INTERIOR PARTITIONS, NONCOMBUSTIBLE			
<b>GA FILE NO. WP 1450</b>	<b>PROPRIETARY*</b>	<b>2 HOUR FIRE</b>	<b>60 to 64 STC SOUND</b>
<b>GYPSUM WALLBOARD, STEEL STUDS</b>			
<p><b>Base</b> layer 5/8" proprietary type X gypsum wallboard or gypsum veneer base applied at right angles to each side of 15/8" proprietary steel studs 24" o.c. with 1" Type S drywall screws 16" o.c. <b>Face</b> layer 5/8" proprietary type X gypsum wallboard or gypsum veneer base applied at right angles to studs with 15/8" Type S drywall screws 16" o.c. Face layer horizontal joints offset not less than 12" from base layer horizontal joints.</p> <p>Horizontal joints on opposite sides need not be staggered or backed. <b>(NLB)</b></p> <p>Sound tested with 35/8" proprietary steel studs, resilient channels, and 3 1/2" glass fiber insulation in stud cavity.</p>			
<p style="text-align: center;"><b>PROPRIETARY GYPSUM BOARD</b></p> <p>CertainTeed Gypsum Inc. - 5/8" ProRoc® Type X Gypsum Panels</p>		<p>Thickness: 4 1/8" (Fire) 6 5/8" (Sound)</p> <p>Approx. Weight: 12 psf</p> <p>Fire Test: UL R3660, 07NK14500, 8-16-07, UL Design V450</p> <p>Sound Test: RAL TL07-359, 11-8-07</p>	
<b>GA FILE NO. WP 1451</b>	<b>PROPRIETARY*</b>	<b>2 HOUR FIRE</b>	<b>60 to 64 STC SOUND</b>
<b>GYPSUM WALLBOARD, STEEL STUDS</b>			
<p><b>Base</b> layer 5/8" proprietary type X gypsum wallboard applied parallel or at right angles to each side of 2 1/2" proprietary steel studs 24" o.c. with 1" Type S drywall screws 24" o.c. <b>Face</b> layer 5/8" type X gypsum wallboard applied parallel or at right angles to each side with 15/8" Type S drywall screws 16" o.c. Face layer horizontal joints offset 12" from base layer horizontal joints. When face layer is applied at right angles to framing locate first screw 1 1/4" from board edge and locate second screw 2" from board edge.</p> <p>Sound tested with horizontal resilient furring channels 24" o.c. and glass fiber insulation in stud cavity. <b>(NLB)</b></p>			
<p style="text-align: center;"><b>PROPRIETARY GYPSUM BOARD</b></p> <p>National Gypsum Company - 5/8" Gold Bond® Brand FIRE-SHIELD® Gypsum Board</p>		<p>Thickness: 5" (Fire) 5 1/2" (Sound)</p> <p>Approx. Weight: 9 psf</p> <p>Fire Test: UL R3501, 07NK12306, 8-24-07, UL Design V450</p> <p>Sound Test: RAL TL05-081, 4-14-05</p>	
<b>GA FILE NO. WP 1470</b>	<b>PROPRIETARY*</b>	<b>2 HOUR FIRE</b>	<b>55 to 59 STC SOUND</b>
<b>GYPSUM WALLBOARD, RESILIENT CHANNELS, STEEL STUDS, MINERAL FIBER INSULATION</b>			
<p>Resilient channels 24" o.c. attached at right angles to ONE SIDE of 3 1/2" 20 gage steel studs 24" o.c. with one 1/2" Type S-12 drywall screw at each stud. <b>Base</b> layer 1/2" proprietary type X gypsum wallboard or gypsum veneer base applied at right angles to channels with 1" Type S drywall screws 24" o.c. <b>Face</b> layer 1/2" proprietary type X gypsum wallboard or gypsum veneer base applied at right angles to channels with 15/8" Type S drywall screws 12" o.c. 3" mineral fiber insulation, 2 pcf, friction fit in stud space.</p> <p><b>OPPOSITE SIDE:</b> <b>Base</b> layer 1/2" proprietary type X gypsum wallboard applied parallel with 1" Type S-12 drywall screws 24" o.c. <b>Face</b> layer 1/2" proprietary type X gypsum wallboard or gypsum veneer base applied parallel to studs with 15/8" Type S-12 drywall screws 12" o.c.</p> <p>Joints staggered 24" each layer and side. <b>(NLB)</b></p>			
<p style="text-align: center;"><b>PROPRIETARY GYPSUM BOARD</b></p> <p>American Gypsum Company LLC - 1/2" FireBloc® Type C            CertainTeed Gypsum Inc. - 1/2" ProRoc® Type C Gypsum Panels            CertainTeed Gypsum Canada Inc. - 1/2" ProRoc® Type C Gypsum Panels            Georgia-Pacific Gypsum LLC - 1/2" ToughRock® Fireguard C™            Lafarge North America Inc. - 1/2" Firecheck® Type C            National Gypsum Company - 1/2" Gold Bond® Brand FIRE-SHIELD C™ Gypsum Board            Temple-Inland - 1/2" TG-C            United States Gypsum Company - 1/2" SHEETROCK® Brand FIRECODE® C Core Gypsum Panels</p>		<p>Thickness: 6"</p> <p>Approx. Weight: 12 psf</p> <p>Fire Test: UL R1319-141 through 145, 2-11-87, UL Design U454</p> <p>Sound Test: RAL TL83-214, 9-1-83</p>	

\*Contact the manufacturer for more detailed information on proprietary products.

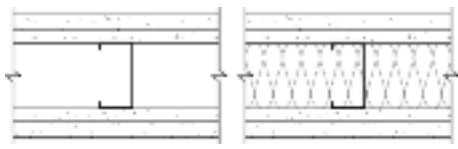
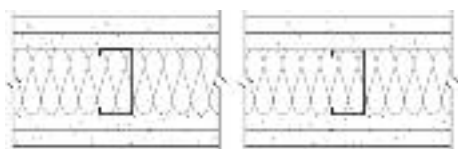
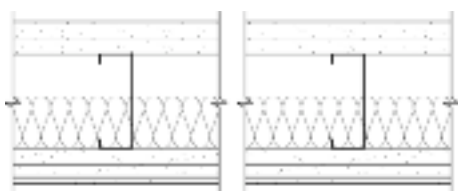
<b>WALLS AND INTERIOR PARTITIONS, NONCOMBUSTIBLE</b>			
<b>GA FILE NO. WP 1505</b>	<b>PROPRIETARY*</b>	<b>2 HOUR FIRE</b>	<b>55 to 59 STC SOUND</b>
<b>GYPSUM WALLBOARD, STEEL STUDS</b>			
<p><b>Base</b> layer 1/2" proprietary type X gypsum wallboard applied at right angles to each side of 2 1/2" steel studs 24" o.c. with 1" Type S drywall screws 12" o.c. <b>Face</b> layer 5/8" proprietary type X gypsum wallboard applied parallel to each side with vertical joints midway between studs. <b>Face</b> layer attached to <b>base</b> layer only with 1 1/2" Type G drywall screws 12" o.c. at vertical joints and centerline of face layer gypsum board. 3/8" to 1/2" diameter adhesive beads around the perimeter of face board, 2" from each edge and end, and in the form of an X joining the corners of the perimeter beads, are optional.</p> <p>Joints staggered 24" each layer and side. Sound tested with adhesive attachment and 2 1/2" glass fiber insulation friction fit in stud space. <b>(NLB)</b></p>			
<p style="text-align: center;"><b>PROPRIETARY GYPSUM BOARD</b></p> <p>CertainTeed Gypsum Canada Inc. - 1/2" ProRoc® Type C Gypsum Panels                      - 5/8" ProRoc® Type X Gypsum Panels                      Georgia-Pacific Gypsum LLC - 1/2" ToughRock® Fireguard C™                      - 5/8" ToughRock® Fireguard®</p>		<p>Thickness: 4 3/4"                      Approx. Weight: 10 psf                      Fire Test: ULC 75T208, 11-20-75,                      ULC Design W404                      Sound Test: DRC 70-18-2, 2-16-70</p>	
<b>GA FILE NO. WP 1506</b>	<b>PROPRIETARY*</b>	<b>2 HOUR FIRE</b>	<b>55 to 59 STC SOUND</b>
<b>GYPSUM WALLBOARD, STEEL STUDS, MINERAL FIBER INSULATION</b>			
<p><b>Base</b> layer 5/8" proprietary type X gypsum wallboard or gypsum veneer base applied parallel to each side of 2 1/2" steel studs 24" o.c. with 1" Type S drywall screws 16" o.c. <b>Face</b> layer 5/8" proprietary type X gypsum wallboard or gypsum veneer base applied at right angles to each side with 1 5/8" Type S drywall screws 16" o.c. at studs and 12" o.c. at top and bottom track. Face layer horizontal joints offset not less than 12" from base layer horizontal joints. Mineral fiber insulation in stud cavity</p> <p>Horizontal joints on opposite sides need not be staggered or backed <b>(NLB)</b></p>			
<p style="text-align: center;"><b>PROPRIETARY GYPSUM BOARD</b></p> <p>CertainTeed Gypsum Inc. - 5/8" ProRoc® Type X Gypsum Panels</p>		<p>Thickness: 5"                      Approx. Weight: 8.25 psf                      Fire Test: UL R3660, 07NK21428,                      2-14-08                      UL Design V419                      Sound Test: NGC 2006049, 1-31-07</p>	
<b>GA FILE NO. WP 1510</b>	<b>GENERIC</b>	<b>2 HOUR FIRE</b>	<b>55 to 59 STC SOUND</b>
<b>GYPSUM WALLBOARD, STEEL STUDS, GLASS FIBER INSULATION</b>			
<p><b>Base</b> layer 5/8" type X gypsum wallboard or gypsum veneer base applied parallel to each side of 3 5/8" steel studs 24" o.c. with 1" Type S drywall screws 32" o.c. 2" glass fiber insulation, 0.9 pcf, stapled to one side in stud space.</p> <p><b>Face</b> layer 5/8" type X gypsum wallboard or gypsum veneer base applied parallel to ONE SIDE with 1 5/8" Type S drywall screws 12" o.c. at edges and 24" o.c. at intermediate studs.</p> <p>OPPOSITE SIDE: <b>Second</b> layer 1/2" type X gypsum wallboard or gypsum veneer base applied parallel to studs with 1 5/8" Type S drywall screws 12" o.c. <b>Face</b> layer 1/4" or 3/8" regular gypsum wallboard laminated parallel to studs with 3/4" daubs of adhesive spaced 12" o.c. each direction.</p> <p>Joints staggered 24" each layer and side. <b>(NLB)</b></p>			
		<p>Thickness: 6 1/4" - 6 3/8" Varies                      Approx. Weight: 11 psf                      Fire Test: UL R3660-1, 8-21-68,                      UL Design U403                      Sound Test: RAL TL69-118, 12-16-68</p>	

\*Contact the manufacturer for more detailed information on proprietary products.

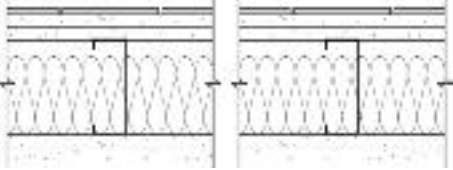
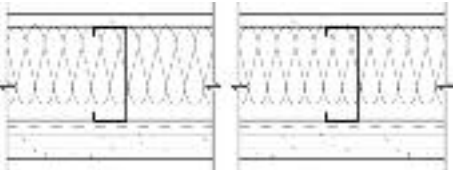

**WALLS AND INTERIOR PARTITIONS, NONCOMBUSTIBLE**

GA FILE NO. WP 1515	PROPRIETARY*	2 HOUR FIRE	55 to 59 FSTC SOUND																								
<p align="center"><b>GYPSUM WALLBOARD, STEEL STUDS, MINERAL FIBER INSULATION, CEMENTITIOUS BACKER UNIT, CERAMIC TILE</b></p>																											
<p><b>Base</b> layer 1/2" proprietary type X gypsum wallboard or gypsum veneer base applied parallel to each side of 35/8" 20 gage steel studs 24" o.c. with 1" Type S drywall screws 24" o.c. 3" proprietary mineral fiber insulation, 2.0 pcf, friction fit in stud space. <b>Face</b> layer 1/2" proprietary type X gypsum wallboard or gypsum veneer base applied parallel to ONE SIDE with 15/8" Type S drywall screws 12" o.c. Joints offset 24" o.c. from base layer joints.</p> <p>OPPOSITE SIDE: <b>Face</b> layer 1/2" proprietary cementitious backer unit applied at right angles with 15/8" Type S-12 wafer head screws 8" o.c. Vertical joints offset 24" from base layer vertical joints. Joints covered with glass fiber mesh tape. Ceramic tile, 1/4" thick, joints grouted, installed with latex-modified portland cement mortar or ANSI A136.1 Type I organic adhesive. <b>(NLB)</b></p>		<p>Thickness: 57/8"                  Approx. Weight: 14 psf                  Fire Test: UL R11270-1, -2, 1-21-85, UL Design U443                  Field Sound Test: SA-851016, 10-14-85</p>																									
<p align="center"><b>PROPRIETARY GYPSUM BOARD</b></p>																											
<table border="0"> <tr> <td>American Gypsum Company LLC</td> <td>-</td> <td>1/2" FireBloc® Type C</td> </tr> <tr> <td>Georgia-Pacific Gypsum LLC</td> <td>-</td> <td>1/2" ToughRock® Fireguard C™</td> </tr> <tr> <td>Lafarge North America Inc.</td> <td>-</td> <td>1/2" Firecheck® Type C</td> </tr> <tr> <td>National Gypsum Company</td> <td>-</td> <td>1/2" Gold Bond® Brand FIRE-SHIELD C™ Gypsum Board</td> </tr> <tr> <td>Temple-Inland</td> <td>-</td> <td>1/2" TG-C</td> </tr> <tr> <td>United States Gypsum Company</td> <td>-</td> <td>1/2" SHEETROCK® Brand FIRECODE® C Core Gypsum Panels</td> </tr> </table>				American Gypsum Company LLC	-	1/2" FireBloc® Type C	Georgia-Pacific Gypsum LLC	-	1/2" ToughRock® Fireguard C™	Lafarge North America Inc.	-	1/2" Firecheck® Type C	National Gypsum Company	-	1/2" Gold Bond® Brand FIRE-SHIELD C™ Gypsum Board	Temple-Inland	-	1/2" TG-C	United States Gypsum Company	-	1/2" SHEETROCK® Brand FIRECODE® C Core Gypsum Panels						
American Gypsum Company LLC	-	1/2" FireBloc® Type C																									
Georgia-Pacific Gypsum LLC	-	1/2" ToughRock® Fireguard C™																									
Lafarge North America Inc.	-	1/2" Firecheck® Type C																									
National Gypsum Company	-	1/2" Gold Bond® Brand FIRE-SHIELD C™ Gypsum Board																									
Temple-Inland	-	1/2" TG-C																									
United States Gypsum Company	-	1/2" SHEETROCK® Brand FIRECODE® C Core Gypsum Panels																									
GA FILE NO. WP 1520	PROPRIETARY*	2 HOUR FIRE	55 to 59 STC SOUND																								
<p align="center"><b>GYPSUM WALLBOARD, RESILIENT CHANNELS, STEEL STUDS, MINERAL FIBER INSULATION</b></p>																											
<p>Resilient channels 24" o.c. attached at right angles to ONE SIDE of 31/2" 20 gage steel studs 24" o.c. with one 1/2" Type S-12 drywall screw at each stud. <b>Base</b> layer 1/2" proprietary type X gypsum wallboard or gypsum veneer base applied at right angles to channels with 1" Type S drywall screws 24" o.c. <b>Face</b> layer 1/2" proprietary type X gypsum wallboard or gypsum veneer base applied at right angles to channels with 15/8" Type S drywall screws 12" o.c. 3" mineral fiber insulation, 2 pcf, friction fit in stud space.</p> <p>OPPOSITE SIDE: One layer 1/2" proprietary type X gypsum wallboard applied parallel to studs with 1" Type S-12 drywall screws 12" o.c.</p> <p>Joints staggered 24" each layer and side. <b>(NLB)</b></p>		<p>Thickness: 51/2"                  Approx. Weight: 9 psf                  Fire Test: UL R1319-141 through 145, 2-11-87, UL Design U453                  Sound Test: RAL TL83-215, 9-2-83</p>																									
<p align="center"><b>PROPRIETARY GYPSUM BOARD</b></p>																											
<table border="0"> <tr> <td>American Gypsum Company LLC</td> <td>-</td> <td>1/2" FireBloc® Type C</td> </tr> <tr> <td>CertainTeed Gypsum Inc.</td> <td>-</td> <td>1/2" ProRoc® Type C Gypsum Panels</td> </tr> <tr> <td>CertainTeed Gypsum Canada Inc.</td> <td>-</td> <td>1/2" ProRoc® Type C Gypsum Panels</td> </tr> <tr> <td>Georgia-Pacific Gypsum LLC</td> <td>-</td> <td>1/2" ToughRock® Fireguard C™</td> </tr> <tr> <td>Lafarge North America Inc.</td> <td>-</td> <td>1/2" Firecheck® Type C</td> </tr> <tr> <td>National Gypsum Company</td> <td>-</td> <td>1/2" Gold Bond® Brand FIRE-SHIELD C™ Gypsum Board</td> </tr> <tr> <td>Temple-Inland</td> <td>-</td> <td>1/2" TG-C</td> </tr> <tr> <td>United States Gypsum Company</td> <td>-</td> <td>1/2" SHEETROCK® Brand FIRECODE® C Core Gypsum Panels</td> </tr> </table>				American Gypsum Company LLC	-	1/2" FireBloc® Type C	CertainTeed Gypsum Inc.	-	1/2" ProRoc® Type C Gypsum Panels	CertainTeed Gypsum Canada Inc.	-	1/2" ProRoc® Type C Gypsum Panels	Georgia-Pacific Gypsum LLC	-	1/2" ToughRock® Fireguard C™	Lafarge North America Inc.	-	1/2" Firecheck® Type C	National Gypsum Company	-	1/2" Gold Bond® Brand FIRE-SHIELD C™ Gypsum Board	Temple-Inland	-	1/2" TG-C	United States Gypsum Company	-	1/2" SHEETROCK® Brand FIRECODE® C Core Gypsum Panels
American Gypsum Company LLC	-	1/2" FireBloc® Type C																									
CertainTeed Gypsum Inc.	-	1/2" ProRoc® Type C Gypsum Panels																									
CertainTeed Gypsum Canada Inc.	-	1/2" ProRoc® Type C Gypsum Panels																									
Georgia-Pacific Gypsum LLC	-	1/2" ToughRock® Fireguard C™																									
Lafarge North America Inc.	-	1/2" Firecheck® Type C																									
National Gypsum Company	-	1/2" Gold Bond® Brand FIRE-SHIELD C™ Gypsum Board																									
Temple-Inland	-	1/2" TG-C																									
United States Gypsum Company	-	1/2" SHEETROCK® Brand FIRECODE® C Core Gypsum Panels																									

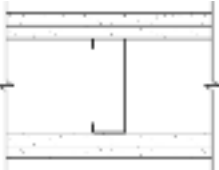
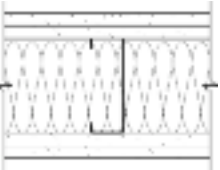
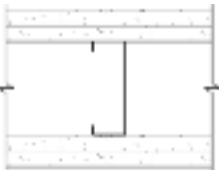
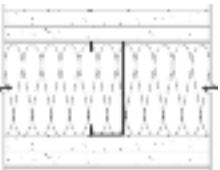
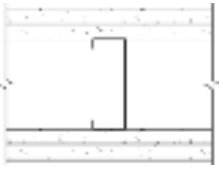
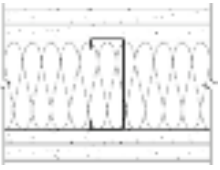
\*Contact the manufacturer for more detailed information on proprietary products.

<b>WALLS AND INTERIOR PARTITIONS, NONCOMBUSTIBLE</b>			
<b>GA FILE NO. WP 1521</b>	<b>GENERIC</b>	<b>2 HOUR FIRE</b>	<b>55 to 59 STC SOUND</b>
<b>GYPSUM WALLBOARD, STEEL STUDS</b>			
<p><b>Base</b> layer 1/2" type X gypsum wallboard or gypsum veneer base applied parallel to each side of 3 5/8" steel studs 24" o.c. with 1" Type S drywall screws 24" o.c. <b>Face</b> layer 1/2" type X gypsum wallboard or gypsum veneer base applied parallel to each side with 1 5/8" Type S drywall screws 12" o.c.</p> <p>Joints staggered 24" each layer and side. Sound tested with 3 1/2" glass fiber friction fit in stud space. <b>(NLB)</b></p>			
<b>GA FILE NO. WP 1522</b>	<b>GENERIC</b>	<b>2 HOUR FIRE</b>	<b>55 to 59 STC SOUND</b>
<b>GYPSUM WALLBOARD, STEEL STUDS</b>			
<p><b>Base</b> layer 5/8" type X gypsum wallboard or gypsum veneer base applied parallel or at right angles to each side of 3 5/8" steel studs 24" o.c. with 1" Type S drywall screws 24" o.c. <b>Face</b> layer 5/8" type X gypsum wallboard or gypsum veneer base applied parallel or at right angles to each side with 1 5/8" Type S drywall screws 12" o.c.</p> <p>Joints staggered 24" each layer and side. Sound tested with 3 1/2" glass fiber friction fit in stud space. <b>(NLB)</b></p>			
<b>GA FILE NO. WP 1523</b>	<b>PROPRIETARY*</b>	<b>2 HOUR FIRE</b>	<b>55 to 59 STC SOUND</b>
<b>GYPSUM WALLBOARD, STEEL STUDS</b>			
<p><b>Base</b> layer 5/8" proprietary type X gypsum wallboard or gypsum veneer base applied at right angles to each side of 3 5/8" steel studs 24" o.c. with 1" Type S drywall screws 16" o.c. <b>Face</b> layer 5/8" proprietary type X gypsum wallboard or gypsum veneer base applied at right angles to each side with 1 5/8" Type S drywall screws 16" o.c. Face layer horizontal joints offset not less than 12" from base layer horizontal joints.</p> <p>Horizontal joints on opposite sides need not be staggered or backed. Sound tested with 3 1/2" glass fiber insulation in stud cavity. <b>(NLB)</b></p>			
<b>PROPRIETARY GYPSUM BOARD</b>			
<p>CertainTeed Gypsum Canada Inc. - 5/8" ProRoc® Type X Gypsum Panels</p>			

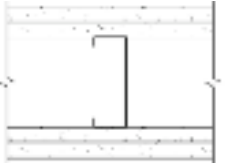
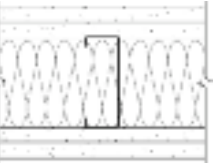
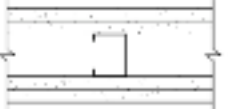
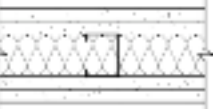
\*Contact the manufacturer for more detailed information on proprietary products.

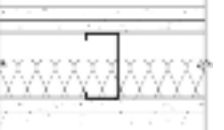

WALLS AND INTERIOR PARTITIONS, NONCOMBUSTIBLE					
GA FILE NO. WP 1524	PROPRIETARY*	2 HOUR FIRE	55 to 59 STC SOUND		
GYPSUM WALLBOARD, STEEL STUDS					
<p><b>Base</b> layer 5/8" proprietary type X gypsum wallboard or gypsum veneer base applied at right angles to each side of 35/8" steel studs 24" o.c. with 1" Type S drywall screws 16" o.c. <b>Face</b> layer 5/8" proprietary type X gypsum wallboard or gypsum veneer base applied at right angles to each side with 15/8" Type S drywall screws 16" o.c. Face layer horizontal joints offset not less than 12" from base layer horizontal joints.</p> <p>Horizontal joints on opposite sides need not be staggered or backed. Sound tested with 3 1/2" glass fiber insulation in stud cavity. (NLB)</p>					
<p><b>PROPRIETARY GYPSUM BOARD</b> CertainTeed Gypsum Inc. - 5/8" ProRoc® Type X Gypsum Panels</p>		<p>Thickness: 6 1/8" Approx. Weight: 10 psf Fire Test: UL R3660, 07NK21428, 2-14-08, UL Design U411 Sound Test: NGC 2006049, 1-31-07</p>			
GA FILE NO. WP 1530	GENERIC	2 HOUR FIRE	50 to 54 FSTC SOUND		
GYPSUM WALLBOARD, STEEL STUDS					
<p><b>Base</b> layer 1/2" type X gypsum wallboard or gypsum veneer base applied parallel to each side of 15/8" steel studs 24" o.c. with 1" Type S drywall screws 12" o.c. <b>Face</b> layer 1/2" type X gypsum wallboard or gypsum veneer base applied parallel to each side with 15/8" Type S drywall screws 12" o.c.</p> <p>Joints staggered 24" each layer and side. Sound tested with 1 1/2" mineral fiber insulation stapled in stud space. (NLB)</p>					
<p>Thickness: 3 5/8" Approx. Weight: 9 psf Fire Test: UC, 12-7-64 Field Sound Test: ACI 1131a, 7-14-64</p>					
GA FILE NO. WP 1545	GENERIC	2 HOUR FIRE	50 to 54 STC SOUND		
GYPSUM WALLBOARD, STEEL STUDS					
<p><b>Base</b> layer 1/2" type X gypsum wallboard or gypsum veneer base applied parallel to each side of 2 1/2" steel studs 24" o.c. with 1" Type S drywall screws 24" o.c. <b>Face</b> layer 1/2" type X gypsum wallboard or gypsum veneer base applied parallel to each side with 15/8" Type S drywall screws 12" o.c.</p> <p>Joints staggered 24" each layer and side. Sound tested with 1 1/2" mineral fiber insulation friction fit in stud space. (NLB)</p>					
<p>Thickness: 4 1/2" Approx. Weight: 9 psf Fire Test: UC, 9-7-64; ULC 80T499, 3-26-81, ULC Design W414 Sound Test: CK 654-40, 9-7-65</p>					

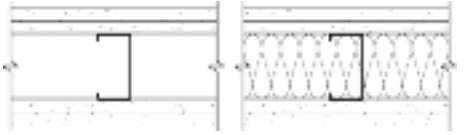
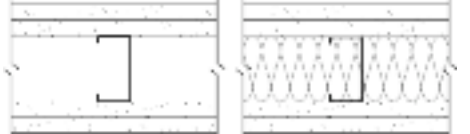
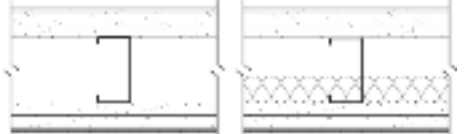
\*Contact the manufacturer for more detailed information on proprietary products.

WALLS AND INTERIOR PARTITIONS, NONCOMBUSTIBLE				
GA FILE NO. WP 1546	GENERIC	2 HOUR FIRE	50 to 54 STC SOUND	<p align="center"><b>GYPSUM WALLBOARD, STEEL STUDS</b></p> <p><b>Base</b> layer 1/2" type X gypsum wallboard or gypsum veneer base applied parallel to each side of 2 1/2" steel studs 24" o.c. with 1" Type S drywall screws 24" o.c. <b>Face</b> layer 1/2" type X gypsum wallboard or gypsum veneer base applied parallel to each side with 1 5/8" Type S drywall screws 12" o.c.</p> <p>Joints staggered 24" each layer and side. Sound tested with 2 1/2" glass fiber friction fit in stud space. <b>(NLB)</b></p>
				<p>Thickness: 4 1/2"</p> <p>Approx. Weight: 9 psf</p> <p>Fire Test: See WP 1545 (UC, 9-7-64; ULC 80T499, 3-26-81, ULC Design W414)</p> <p>Sound Test: NRCC 798-NV, 2-2-81</p>
GA FILE NO. WP 1548	GENERIC	2 HOUR FIRE	50 to 54 STC SOUND	<p align="center"><b>GYPSUM WALLBOARD, STEEL STUDS</b></p> <p><b>Base</b> layer 5/8" type X gypsum wallboard or gypsum veneer base applied parallel or at right angles to each side of 2 1/2" steel studs 24" o.c. with 1" Type S drywall screws 24" o.c. <b>Face</b> layer 5/8" type X gypsum wallboard or gypsum veneer base applied parallel or at right angles to each side with 1 5/8" Type S drywall screws 12" o.c.</p> <p>Joints staggered 24" each layer and side. Sound tested with 2 1/2" glass fiber insulation friction fit in stud space. <b>(NLB)</b></p>
				<p>Thickness: 5"</p> <p>Approx. Weight: 12 psf</p> <p>Fire Test: WHI-495-0236, 1-30-80</p> <p>Sound Test: WHI-218-1, 6-11-80</p>
GA FILE NO. WP 1560	GENERIC	2 HOUR FIRE	50 to 54 STC SOUND	<p align="center"><b>GYPSUM VENEER PLASTER, GYPSUM VENEER BASE, STEEL STUDS</b></p> <p><b>Base</b> layer 1/2" type X gypsum veneer base applied parallel to each side of 2 1/2" steel studs 24" o.c. with 1" Type S drywall screws 24" o.c. at vertical joints and intermediate studs. <b>Face</b> layer 1/2" type X gypsum veneer base applied parallel to each side with 1 5/8" Type S drywall screws 12" o.c. at vertical joints and intermediate studs. 3/32" gypsum veneer plaster applied over each side.</p> <p>Joints staggered 24" each layer and side. Sound tested with 1" mineral fiber insulation stapled in stud space. <b>(NLB)</b></p>
				<p>Thickness: 4 3/4"</p> <p>Approx. Weight: 10 psf</p> <p>Fire Test: UL R5085-7, R4142, 12-1-66 (Rev. 1-16-80), UL Design U424</p> <p>Sound Test: CK 654-66, 12-29-65</p>

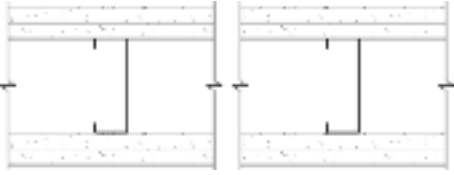
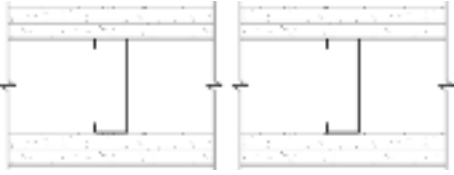
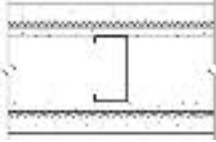
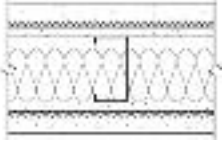

WALLS AND INTERIOR PARTITIONS, NONCOMBUSTIBLE				
GA FILE NO. WP 1565	PROPRIETARY*	2 HOUR FIRE	50 to 54 STC SOUND	<p align="center"><b>GYPSUM WALLBOARD, STEEL STUDS, MINERAL FIBER INSULATION, CEMENTITIOUS BACKER UNIT</b></p> <p><b>Base</b> layer 1/2" proprietary type X gypsum wallboard or veneer base applied parallel to each side of 3 5/8" 25 gage steel studs 16" o.c. with 1" Type S drywall screws 24" o.c.</p> <p><b>Face</b> layer 1/2" proprietary type X gypsum wallboard or veneer base applied parallel to ONE SIDE with 1 5/8" Type S drywall screws 12" o.c. 3" mineral fiber insulation batts, 2.5 pcf, in stud space.</p> <p>OPPOSITE SIDE: <b>Face</b> layer 1/2" proprietary cementitious backer units applied parallel to studs with 1 5/8" Type S wafer head screws 8" o.c.</p> <p>Joints staggered 16" each layer and side. (NLB)</p> <p align="center"><b>PROPRIETARY GYPSUM BOARD</b></p> <p>National Gypsum Company - 1/2" Gold Bond® Brand FIRE-SHIELD C™ Gypsum Board</p>
GA FILE NO. WP 1570	PROPRIETARY*	2 HOUR FIRE	50 to 54 FSTC SOUND	<p align="center"><b>GYPSUM WALLBOARD, STEEL STUDS, MINERAL FIBER INSULATION</b></p> <p>One layer 3/4" proprietary type X gypsum wallboard applied parallel to each side of 3 1/2" steel studs 24" o.c. with 1 1/4" Type S drywall screws 8" o.c. at vertical joints and 12" o.c. at intermediate studs. 3" proprietary mineral fiber insulation, 2.0 pcf, friction fit in stud space.</p> <p>Joints staggered 24" on opposite sides. (NLB)</p> <p align="center"><b>PROPRIETARY GYPSUM BOARD</b></p> <p>United States Gypsum Company - 3/4" SHEETROCK® Brand ULTRACODE® Core Gypsum Panels</p>
GA FILE NO. WP 1615	GENERIC	2 HOUR FIRE	45 to 49 STC SOUND	<p align="center"><b>GYPSUM WALLBOARD, STEEL STUDS</b></p> <p><b>Base</b> layer 1/2" type X gypsum wallboard or gypsum veneer base applied parallel to each side of 2 1/2" steel studs 24" o.c. with 1" Type S drywall screws 24" o.c. <b>Face</b> layer 1/2" type X gypsum wallboard or gypsum veneer base applied parallel to each side with 1 5/8" Type S drywall screws 12" o.c.</p> <p>Joints staggered 24" each layer and side. (NLB)</p>

\*Contact the manufacturer for more detailed information on proprietary products.

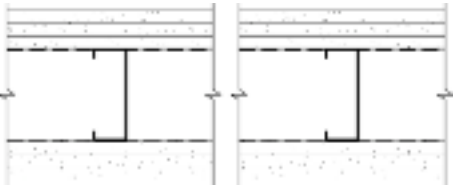

<b>WALLS AND INTERIOR PARTITIONS, NONCOMBUSTIBLE</b>				
<b>GA FILE NO. WP 1616</b>	<b>GENERIC</b>	<b>2 HOUR FIRE</b>	<b>45 to 49 STC SOUND</b>	
<b>GYPSUM WALLBOARD, STEEL STUDS</b>				
<p><b>Base</b> layer 5/8" type X gypsum wallboard or gypsum veneer base applied parallel to each side of 3 5/8" steel studs 24" o.c. with 1" Type S drywall screws 8" o.c. at vertical joints and 12" o.c. at intermediate studs. <b>Face</b> layer 5/8" plain or predecorated type X gypsum wallboard or gypsum veneer base applied parallel to each side laminating compound combed over entire surface. Metal base and top retainer channels.</p> <p>Joints staggered 24" each layer and side. <b>(NLB)</b></p>				<p>Thickness: 6 1/8"                      Approx. Weight: 10 psf                      Fire Test: UL R1319-31, 6-2-60, UL Design U411                      Sound Test: NGC 2005005, 6-15-05                      RAL TL06-115, 4-12-06</p>
<b>GA FILE NO. WP 1625</b>	<b>PROPRIETARY*</b>	<b>2 HOUR FIRE</b>	<b>45 to 49 STC SOUND</b>	
<b>GYPSUM PLASTER, GYPSUM LATH, METAL LATH, STEEL STUDS</b>				
<p>One layer 3/8" thick proprietary gypsum lath applied at right angles to each side of 2 1/2" 20 gage steel studs 16" o.c. with 1" Type S drywall screws 8" o.c. Mineral fiber batts (optional) in stud space. 3.4 lb self furring diamond mesh metal lath applied to each side over gypsum lath with 1" Type S screws. 3/4" 1:2 gypsum-sand plaster with a lime gauging plaster finish applied over each side.</p> <p>Sound tested with 2" mineral fiber stapled in stud space. <b>(NLB)</b></p> <p style="text-align: center;"><b>PROPRIETARY GYPSUM LATH</b>                      United States Gypsum Company - 3/8" ROCKLATH® FIRECODE® Core Plaster Base</p>				<p>Thickness: 4 3/4"                      Approx. Weight: 16 psf                      Fire Test: UL R1319, 2-28-90, UL Design U484                      Sound Test: CK 664-17, 4-1-66; CK 664-18, 4-6-66</p>
<b>GA FILE NO. WP 1630</b>	<b>GENERIC</b>	<b>2 HOUR FIRE</b>	<b>45 to 49 STC SOUND</b>	
<b>GYPSUM WALLBOARD, STEEL STUDS</b>				
<p><b>Base</b> layer 1/2" type X gypsum wallboard or gypsum veneer base applied parallel to each side of 2 1/2" steel studs 24" o.c. with 1" Type S drywall screws 12" o.c. at vertical joints and wall perimeter and 36" o.c. at intermediate studs. <b>Face</b> layer 1/2" type X gypsum wallboard or gypsum veneer base applied parallel to each side with 4" wide strips of drywall laminating adhesive 2" from board edges and 4" off board centerline and 1 3/4" Type S drywall screws 12" o.c. at wall perimeter and 16" o.c. at intermediate studs.</p> <p>Joints staggered 24" each layer and side. <b>(NLB)</b></p>				<p>Thickness: 4 1/2"                      Approx. Weight: 9 psf                      Fire Test: OSU T-3218, 9-17-65                      Sound Test: NGC 2111, 2-6-67</p>

\*Contact the manufacturer for more detailed information on proprietary products.



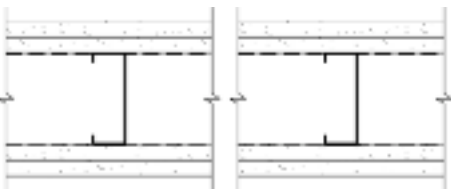

WALLS AND INTERIOR PARTITIONS, NONCOMBUSTIBLE			
<p><b>GA FILE NO. WP 1632</b></p>	<p><b>PROPRIETARY*</b></p>	<p><b>2 HOUR FIRE</b></p>	<p><b>45 to 49 STC SOUND</b></p>
<p><b>GYPSUM WALLBOARD, GLASS MAT GYPSUM BOARD, STEEL STUDS</b></p>			
<p><b>Base</b> layer 1/2" proprietary type X gypsum wallboard applied parallel to each side of 2 1/2" steel studs 24" o.c. with 1" Type S drywall screws 24" o.c. <b>Face</b> layer 1/2" proprietary glass mat water-resistant gypsum backing board applied parallel to each side with 1 5/8" Type S drywall screws 8" o.c. at vertical joints and 12" o.c. at intermediate studs and wall perimeter.</p>		<p>Thickness: 4 1/2"                  Approx. Weight: 9 psf                  Fire Test: CTC 1894-1530, 1-15-88                  Sound Test: See WP 1615 (NGC 2250, 1-3-68)</p>	
<p>Joints staggered 24" each layer and side and covered with 10 x 10 mesh glass tape and tile adhesive. <b>(NLB)</b></p>			
<p><b>PROPRIETARY GYPSUM PANEL PRODUCTS</b>                  Georgia-Pacific Gypsum LLC - 1/2" DensShield®                  - 1/2" ToughRock® Fireguard C™</p>			
<p><b>GA FILE NO. WP 1635</b></p>	<p><b>GENERIC</b></p>	<p><b>2 HOUR FIRE</b></p>	<p><b>45 to 49 STC SOUND</b></p>
<p><b>GYPSUM WALLBOARD, STEEL STUDS</b></p>			
<p><b>Base</b> layer 1/2" type X gypsum wallboard or gypsum veneer base applied parallel to each side of 3 1/2" 20 gage steel studs 24" o.c. with 1" Type S-12 drywall screws 12" o.c. <b>Second</b> layer 1/2" type X gypsum wallboard or gypsum veneer base applied parallel to each side with 1 5/8" Type S-12 drywall screws 12" o.c. <b>Face</b> layer 1/2" type X gypsum wallboard or gypsum veneer base applied parallel or at right angles to each side with 1 7/8" Type S-12 drywall screws 12" o.c. and 1 1/2" Type G screws 12" o.c. midway between studs. Studs attached to each side of floor and ceiling runners by welding or with 1/2" Type S-12 panhead screws.</p>		<p>Thickness: 6 1/2"                  Approx. Weight: 11 psf                  Fire Test: UL NC 505-4, 7-29-82, UL Design U425                  Sound Test: Estimated</p>	
<p>Joints staggered 24" each layer and side.</p> <p><b>Bracing:</b> Lateral bracing spaced not over 40" o.c. shall be 1" by 18 gage steel straps attached to each side or channel bracing attached to each stud with a clip angle. For studs with holes or punch-outs in the web the "Q" factor shall be determined by means of stub column tests. Tested at 100 percent of design load. <b>(LOAD-BEARING)</b></p>			
<p><b>GA FILE NO. WP 1714</b></p>	<p><b>GENERIC</b></p>	<p><b>2 HOUR FIRE</b></p>	<p><b>40 to 44 STC SOUND</b></p>
<p><b>GYPSUM WALLBOARD, STEEL STUDS</b></p>			
<p><b>Base</b> layer 5/8" type X gypsum wallboard or gypsum veneer base applied parallel to 2 1/2" 18 gage steel studs 16" o.c. with 1" Type S-12 drywall screws 12" o.c. <b>Face</b> layer 5/8" type X gypsum wallboard or gypsum veneer base applied parallel to each side with 1 5/8" Type S-12 drywall screws 12" o.c. Studs attached to each side of floor and ceiling runners by welding.</p>		<p>Thickness: 5"                  Approx. Weight: 10 psf                  Fire Test: FM WP 199-2, 1-25-71                  Sound Test: See WP 1615 (NGC 2250, 1-3-68)</p>	
<p>Joints staggered 16" each layer and side.</p> <p><b>Bracing:</b> Lateral bracing on each side shall be 3/4" cold rolled channel at 1/3 points screw attached with 1/2" Type S-12 drywall screws. Tested at 100 percent of design load. <b>(LOAD-BEARING)</b></p>			

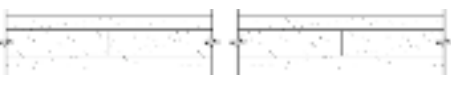
\*Contact the manufacturer for more detailed information on proprietary products.

<b>WALLS AND INTERIOR PARTITIONS, NONCOMBUSTIBLE</b>			
<b>GA FILE NO. WP 1716</b>	<b>GENERIC</b>	<b>2 HOUR FIRE</b>	<b>40 to 44 STC SOUND</b>
<b>GYPSUM WALLBOARD, STEEL STUDS</b>			
<p><b>Base</b> layer 5/8" type X gypsum wallboard or gypsum veneer base applied parallel to each side of 3 1/2" 20 gage steel studs 24" o.c. with 1" Type S-12 drywall screws 12" o.c. <b>Face</b> layer 5/8" type X gypsum wallboard or gypsum veneer base applied parallel to each side with 1 5/8" Type S-12 drywall screws 12" o.c. Studs attached to each side of floor and ceiling runners by welding or with 1/2" Type S-12 panhead screws.</p> <p>Joints staggered 24" each layer and side.</p> <p><b>Bracing:</b> Lateral bracing spaced not over 40" o.c. shall be 1" by 18 gage steel straps attached to each side or channel bracing attached to each stud with a clip angle. For studs with holes or punch-outs in the web the "Q" factor shall be determined by means of stub column tests. <b>Tested at 80 percent of design load. (LIMITED LOAD-BEARING)</b></p>		<p>Thickness: 6"                      Approx. Weight: 10 psf                      Fire Test: UL NC 505-6, 7-29-82, UL Design U425                      Sound Test: See WP 1615 (NGC 2250, 1-3-68)</p>	
<b>GA FILE NO. WP 1830</b>	<b>GENERIC</b>	<b>2 HOUR FIRE</b>	<b>35 to 39 STC SOUND</b>
<b>SEMI-SOLID GYPSUM WALLBOARD, GYPSUM STUDS</b>			
<p><b>Base</b> layer 1/2" type X gypsum wallboard or gypsum veneer base applied parallel to each side of 1 5/8" x 6" type X gypsum board studs 24" o.c. with laminating compound combed over entire surface of gypsum studs and 2" Type G drywall screws 24" o.c. <b>Face</b> layer 1/2" type X gypsum wallboard or gypsum veneer base applied parallel to each side with laminating compound combed over entire contact surface, 2" Type G drywall screws 24" o.c. at gypsum studs and 1 1/2" Type S drywall screws 24" o.c. at floor and ceiling channels.</p> <p>Joints staggered 24" each layer and side. <b>(NLB)</b></p>		<p>Thickness: 3 5/8"                      Limiting Height: 14'0"                      Approx. Weight: 10 psf                      Fire Test: UC, 2-8-62                      Sound Test: See WP 1330 (Based on G&amp;H BW-8FT, 8-1-62)</p>	
<b>GA FILE NO. WP 1841</b>	<b>PROPRIETARY*</b>	<b>2 HOUR FIRE</b>	<b>35 to 39 STC SOUND</b>
<b>SOLID GYPSUM WALLBOARD</b>			
<p>One layer 1/2" proprietary type X gypsum wallboard or gypsum veneer base applied parallel to each side of 1" x 24" proprietary type X gypsum panels with laminating compound combed over the entire contact surface and 1 5/16" Type S screws 24" o.c. horizontally and vertically. 1" gypsum coreboard panels attached to 25 gage 1" x 2 1/4" high "L" runners along floor and ceiling lines with two 1 5/16" Type S screws at top and bottom. Wallboard layers attached to "L" runners with 1 7/8" Type S screws 12" o.c.</p> <p>Joints staggered 12" on opposite sides. <b>(NLB)</b></p> <p style="text-align: center;"><b>PROPRIETARY GYPSUM BOARD</b></p> <p>National Gypsum Company      - 1/2" Gold Bond® Brand FIRE-SHIELD C™ Gypsum Wallboard                      - 1" Gold Bond® Brand FIRE-SHIELD® Shaftliner</p>		<p>Thickness: 2"                      Limiting Height: Refer to manufacturer                      Approx. Weight: 8 psf                      Fire Test: UL R3501, 92NK28896, 6-4-93, UL Design U525; FM WP-668, 6-28-82                      Sound Test: Based on NGC 2359, 11-18-69</p>	

\*Contact the manufacturer for more detailed information on proprietary products.

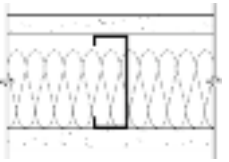
WALLS AND INTERIOR PARTITIONS, NONCOMBUSTIBLE				
GA FILE NO. WP 1870	PROPRIETARY*	2 HOUR FIRE	35 to 39 STC SOUND	
<p align="center"><b>SOLID GYPSUM WALLBOARD, PROTECTED STEEL H MEMBERS</b></p>				
<p>Two 1" x 24" proprietary type X gypsum panels installed vertically between floor and ceiling runners and friction fit into "H" members 24" o.c. One layer 1/2" x 6" wide strips proprietary type X gypsum wallboard applied to each side over steel flanges and runners with 1" Type S drywall screws 12" o.c. (NLB)</p>				
<p align="center"><b>PROPRIETARY GYPSUM BOARD</b></p>				
<p>Georgia-Pacific Gypsum LLC</p>	<p>- 1/2" ToughRock® Fireguard C™ - 1" ToughRock® Fireguard® Shaftliner</p>	<p>Thickness: 3" Approx. Weight: 9.5 psf Fire Test: WHI 495-0743, 1-28-86; WHI 495-0744, 1-30-86; CTC 1869-0438, 9-22-87 Sound Test: Estimated</p>		
GA FILE NO. WP 1930	GENERIC	2 HOUR FIRE	30 to 34 STC SOUND	
<p align="center"><b>SOLID GYPSUM PLASTER, METAL CHANNEL, METAL LATH</b></p>				
<p>2 1/2" solid 1:2 or 1:3 gypsum-perlite plaster applied over 3.4 lb metal lath wire tied 6" o.c. to one side of 3/4" cold rolled channel studs 16" o.c. embedded in the plaster. (NLB)</p>				
				<p>Thickness: 2 1/2" Limiting Height: 12'0" Approx. Weight: 12 psf Fire Test: UL R3453, 2-13-52 Sound Test: See WP 1380 (BMS 144/523, 2-25-55; NBS Monograph 77, 11-30-64)</p>
GA FILE NO. WP 1941	PROPRIETARY*	2 HOUR FIRE		
<p align="center"><b>GYPSUM WALLBOARD, STEEL STUDS, MINERAL FIBER INSULATION</b></p>				
<p>One layer 3/4" proprietary type X gypsum wallboard or gypsum veneer base applied parallel or at right angles to each side of 3 1/2" 20 gage steel studs 24" o.c. with 1 1/4" Type S drywall screws 8" o.c. at vertical edges and either 12" o.c. at intermediate studs when applied parallel to studs or 8" o.c. at intermediate studs when applied at right angles to studs. 3" mineral fiber insulation, 3.0 pcf, friction fit in stud space.</p>				
<p>Vertical joints staggered 24" on opposite sides. (NLB)</p>				
<p align="center"><b>PROPRIETARY GYPSUM BOARD</b></p>				
<p>United States Gypsum Company</p>	<p>- 3/4" SHEETROCK® Brand ULTRACODE® Core Gypsum Panels</p>	<p>Thickness: 5" Approx. Weight: 7 psf Fire Test: UL R1319, 91NK16132, 11-18-91 (rev. 12-15-92), UL Design U491; UL R1319, 96NK11081, 4-3-97, UL Design U419</p>		

\*Contact the manufacturer for more detailed information on proprietary products.

**WALLS AND INTERIOR PARTITIONS, NONCOMBUSTIBLE**

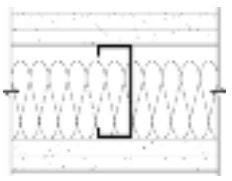
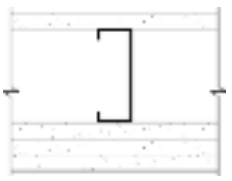
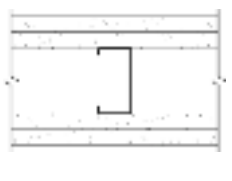
GA FILE NO. WP 1942	PROPRIETARY*	2 HOUR FIRE
<p align="center"><b>GYPSUM WALLBOARD, STEEL STUDS, MINERAL FIBER INSULATION, CEMENTITIOUS BACKER UNITS</b></p> <p><b>Base</b> layer 5/8" proprietary type X gypsum wallboard or gypsum sheathing applied parallel or at right angles to one side of 3 1/2" 20 gage steel studs 16" o.c. with 1" Type S drywall screws 12" o.c. <b>Face</b> layer 1/2" or 5/8" proprietary cementitious backer units applied parallel or at right angles to studs with 1 5/8" corrosion resistant Type S-12 wafer-head screws 8" o.c. 3" mineral fiber insulation, 3.0 pcf, friction fit in stud space.</p> <p>OPPOSITE SIDE: <b>Base</b> layer 5/8" proprietary type X gypsum board or gypsum veneer base applied parallel or at right angles to studs with 1" Type S drywall screws 16" o.c. <b>Face</b> layer 5/8" proprietary type X gypsum board or gypsum veneer base applied parallel or at right angles to studs with 1 5/8" Type S drywall screws 16" o.c.</p> <p>Vertical joints staggered 16" each layer and side, horizontal joints staggered 12" each layer and side. <b>(LOAD-BEARING)</b></p> <p align="center"><b>PROPRIETARY GYPSUM BOARD</b> United States Gypsum Company - 5/8" SHEETROCK® Brand FIRECODE® Core Gypsum Panels</p>		 <p>Thickness: 5 7/8" Approx. Weight: 10 psf Fire Test: UL R12262, 98NK38523, 1-27-98 &amp; 98NK4375, 1-26-98, UL Design U404</p>
<p align="center"><b>GYPSUM WALLBOARD, STEEL STUDS</b></p> <p><b>Base</b> layer 5/8" proprietary type X gypsum wallboard applied parallel to each side of 3 1/2" 25 gage steel studs 24" o.c. with 1 1/8" Type S drywall screws 8" o.c. at vertical joints and wall perimeter and 12" o.c. at intermediate studs. <b>Second</b> layer 5/8" proprietary type X gypsum wallboard applied parallel to studs ONE SIDE ONLY with 1 5/8" Type S drywall screws 12" o.c. <b>Face</b> layer 5/8" proprietary type X gypsum wallboard applied parallel to studs ONE SIDE ONLY with 2 1/4" Type S drywall screws 8" o.c. at vertical joints and wall perimeter and 12" o.c. at intermediate studs.</p> <p>Vertical joints staggered 24" each layer and side. <b>(NLB)</b></p> <p align="center"><b>PROPRIETARY GYPSUM BOARD</b> National Gypsum Company - 5/8" Gold Bond® Brand FIRE-SHIELD® Gypsum Board</p>		 <p>Thickness: 6" Approx. Weight: 9 psf Fire Test: UL R3501, 03NK13365, 10-27-03, UL Design V449</p>
<p align="center"><b>GYPSUM PANEL PRODUCTS, STEEL STUDS</b></p> <p><b>Base</b> layer 5/8" proprietary type X gypsum wallboard or gypsum panel products applied parallel to each side of 2 1/2" proprietary steel studs 24" o.c. with 1" Type S drywall screws 12" o.c. at top and bottom track and 16" o.c. at studs. <b>Face</b> layer 5/8" proprietary type X gypsum wallboard or gypsum panel products applied parallel to each side of studs with 1 5/8" Type S drywall screws 12" o.c. at top and bottom runner and 16" o.c. at studs. Face layer joints offset 24" from base layer joints.</p> <p>Joints staggered 24" each layer and side. <b>(NLB)</b></p> <p align="center"><b>PROPRIETARY GYPSUM PANEL PRODUCTS</b> American Gypsum Company LLC - 5/8" FireBloc® Type X Georgia-Pacific Gypsum LLC - 5/8" DensArmor Plus® Fireguard® Interior Guard Lafarge North America Inc. - 5/8" Firecheck® Type X</p>		 <p>Thickness: 5" Approx. Weight: 9 psf Fire Test: UL R14196, 07NK11544, 8-6-07, UL Design V450</p>

\*Contact the manufacturer for more detailed information on proprietary products.

## WALLS AND INTERIOR PARTITIONS, NONCOMBUSTIBLE

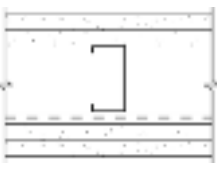
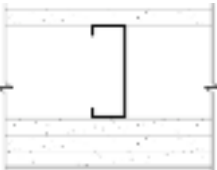
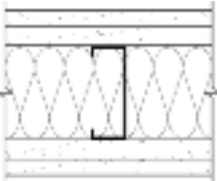
GA FILE NO. WP 1945	PROPRIETARY*	2 HOUR FIRE					
<p style="text-align: center;"><b>GYPSUM PANEL PRODUCTS, STEEL STUDS, RESILIENT CHANNELS</b></p> <p>Resilient channels 16" o.c. attached at right angles to ONE SIDE of 2 1/2" proprietary steel studs 24" o.c. with 1/2" Type S-12 panhead screws. <b>Base</b> layer 5/8" proprietary type X gypsum wallboard or glass mat gypsum panels applied at right angles to channels with 1" Type S drywall screws 12" o.c. at top and bottom of the wall and 16" o.c. in the field of the wall. <b>Face</b> layer 5/8" proprietary type X gypsum wallboard or glass mat gypsum panels applied at right angles to channels with 1 5/8" Type S drywall screws 12" o.c. at top and bottom of the wall and 16" o.c. in the field of the wall. Face layer joints offset 24" from base layer joints.</p> <p>OPPOSITE SIDE: <b>Base</b> layer 5/8" proprietary type X gypsum wallboard or glass mat gypsum panels applied parallel to studs with 1" Type S drywall screws 12" o.c. at top and bottom runners and 16" o.c. in the field of the wall. <b>Face</b> layer 5/8" proprietary type X gypsum wallboard or glass mat gypsum panels applied parallel to studs with 1 5/8" Type S drywall screws 12" o.c. at top and bottom runners and 16" o.c. in the field of the wall. Face layer joints offset 24" from base layer joints.</p> <p>Joints staggered 24" each layer and side. <b>(NLB)</b></p> <p style="text-align: center;"><b>PROPRIETARY GYPSUM PANEL PRODUCTS</b></p> <table style="width: 100%; border: none;"> <tr> <td style="border: none;">American Gypsum Company LLC</td> <td style="border: none; text-align: center;">-</td> <td style="border: none;">5/8" FireBloc® Type X</td> </tr> <tr> <td style="border: none;">Georgia-Pacific Gypsum LLC</td> <td style="border: none; text-align: center;">-</td> <td style="border: none;">5/8" DensArmor Plus® Fireguard® Interior Guard</td> </tr> </table>	American Gypsum Company LLC	-	5/8" FireBloc® Type X	Georgia-Pacific Gypsum LLC	-	5/8" DensArmor Plus® Fireguard® Interior Guard	 <p style="margin-top: 20px;">Thickness: 5 1/2" Approx. Weight: 9 psf Fire Test: UL R14196, 07NK11544, 8-6-07, UL Design V450</p>
American Gypsum Company LLC	-	5/8" FireBloc® Type X					
Georgia-Pacific Gypsum LLC	-	5/8" DensArmor Plus® Fireguard® Interior Guard					
<p style="text-align: center;"><b>GA FILE NO. WP 1946</b></p> <p style="text-align: center;"><b>PROPRIETARY*</b></p> <p style="text-align: center;"><b>2 HOUR FIRE</b></p> <p style="text-align: center;"><b>GYPSUM WALLBOARD, STEEL STUDS</b></p> <p>One layer 5/8" proprietary type X gypsum wallboard applied parallel or at right angles to ONE SIDE of 3 1/2", 25 gage steel studs 24" o.c. with 1" Type S drywall screws 8" o.c. at vertical joints and 12" o.c. at intermediate studs when applied parallel to framing, or 8" o.c. at vertical joints and in the field when applied at right angles to framing.</p> <p>OPPOSITE SIDE: <b>Base</b> layer 5/8" proprietary type X gypsum wallboard applied parallel or at right angles to studs with 1" Type S drywall screws 8" o.c. at vertical joints and 12" o.c. at intermediate studs when applied parallel to framing, or 8" o.c. at vertical joints and in the field when applied at right angles to framing. <b>Second</b> layer 5/8" proprietary type X gypsum wallboard applied parallel or at right angles to studs with 1 5/8" Type S drywall screws 12" o.c. <b>Face</b> layer 5/8" proprietary type X gypsum wallboard applied parallel or at right angles to studs with 2 3/8" Type S drywall screws 8" o.c. at vertical joints and 12" o.c. at intermediate studs when applied parallel to framing, or 8" o.c. at vertical joints and in the field when applied at right angles to framing. Horizontal joints staggered not less than 6" between layers. When gypsum panels are other than 48" wide, panels are applied at right angles to the framing.</p> <p>Vertical joints staggered 24" each layer and side. <b>(NLB)</b></p> <p style="text-align: center;"><b>PROPRIETARY GYPSUM BOARD</b></p> <table style="width: 100%; border: none;"> <tr> <td style="border: none;">United States Gypsum Company</td> <td style="border: none; text-align: center;">-</td> <td style="border: none;">5/8" SHEETROCK® Brand FIRECODE® Core Gypsum Panels</td> </tr> </table>	United States Gypsum Company	-	5/8" SHEETROCK® Brand FIRECODE® Core Gypsum Panels	 <p style="margin-top: 20px;">Thickness: 6" Approx. Weight: 8.5 psf Fire Test: UL R1319, 01NK40260, 12-17-01; UL R1319, 06NK16621, 07-06-06; UL Design U408; ULC Design W451</p>			
United States Gypsum Company	-	5/8" SHEETROCK® Brand FIRECODE® Core Gypsum Panels					
<p style="text-align: center;"><b>GA FILE NO. WP 1947</b></p> <p style="text-align: center;"><b>PROPRIETARY*</b></p> <p style="text-align: center;"><b>2 HOUR FIRE</b></p> <p style="text-align: center;"><b>GYPSUM WALLBOARD, STRUCTURAL CEMENT PANELS, GLASS FIBER INSULATION, STEEL STUDS</b></p> <p><b>Base</b> layer 3/4" proprietary structural cement panels applied at right angles to each side of 3 1/2", 20 gage steel studs 16" o.c. with #8 by 1 5/8" self-drilling wing screws 8" o.c. <b>Face</b> layer 5/8" proprietary type X gypsum wallboard applied parallel or at right angles to each side with #6 by 2" Type S-12 drywall screws 8" o.c. Face layer horizontal joints offset 2" from base layer joints. Glass fiber insulation, 3 1/2" thick, friction fit in stud space. <b>(LOAD-BEARING)</b></p> <p>ALTERNATE INSTALLATION: Two layers of proprietary structural cement panels applied at the top of the wall with the <b>base</b> layer a minimum of 12" wide and the <b>face</b> layer a minimum of 10" wide. Remainder of the <b>face</b> layer is 5/8" proprietary type X gypsum wallboard applied as described above. Glass fiber insulation as described above. <b>(LOAD-BEARING)</b></p> <p style="text-align: center;"><b>PROPRIETARY GYPSUM BOARD</b></p> <table style="width: 100%; border: none;"> <tr> <td style="border: none;">United States Gypsum Company</td> <td style="border: none; text-align: center;">-</td> <td style="border: none;">5/8" SHEETROCK® Brand FIRECODE® Core Gypsum Panels</td> </tr> </table>	United States Gypsum Company	-	5/8" SHEETROCK® Brand FIRECODE® Core Gypsum Panels	 <p style="margin-top: 20px;">Thickness: 6 1/4" Approx. Weight: 10.5 psf Fire Test: UL R25352, 07CA23480, 8-27-07, UL Design V465</p>			
United States Gypsum Company	-	5/8" SHEETROCK® Brand FIRECODE® Core Gypsum Panels					

*\*Contact the manufacturer for more detailed information on proprietary products.*

<b>WALLS AND INTERIOR PARTITIONS, NONCOMBUSTIBLE</b>			
<b>GA FILE NO. WP 2800</b>	<b>PROPRIETARY*</b>	<b>3 HOUR FIRE</b>	<b>55 to 59 FSTC SOUND</b>
<b>GYPSUM WALLBOARD, STEEL STUDS</b>			
<p><b>Base</b> layer 1/2" proprietary type X gypsum wallboard or gypsum veneer base applied parallel to each side of 1 5/8" steel studs 24" o.c. with 1" Type S drywall screws 24" o.c. <b>Second</b> layer 1/2" proprietary type X gypsum wallboard or gypsum veneer base applied parallel to each side with 1 5/8" Type S drywall screws 24" o.c. <b>Face</b> layer 1/2" proprietary type X gypsum wallboard or gypsum veneer base applied parallel or at right angles to each side with 2 1/4" Type S drywall screws 12" o.c. and 1 1/2" Type G drywall screws midway between studs 1" above and below horizontal joints for right angle application.</p> <p>Joints staggered 24" each layer and side. Sound tested with 1 1/2" mineral fiber insulation friction fit in stud space. <b>(NLB)</b></p>			
<p style="text-align: center;"><b>PROPRIETARY GYPSUM BOARD</b></p> <p>United States Gypsum Company - 1/2" SHEETROCK® Brand FIRECODE® C Core Gypsum Panels</p>		<p>Thickness: 4 5/8"                      Approx. Weight: 13 psf                      Fire Test: UL R1319-138, 139, 5-27-82, UL Design U435                      Field Sound Test: SA-830112, 1-12-83</p>	
<b>GA FILE NO. WP 2921</b>	<b>PROPRIETARY*</b>	<b>3 HOUR FIRE</b>	<b>50 to 54 STC SOUND</b>
<b>GYPSUM WALLBOARD, STEEL STUDS</b>			
<p><b>Base</b> layer 1/2" proprietary type X gypsum wallboard or gypsum veneer base applied parallel to each side of 1 5/8" steel studs 24" o.c. with 1" Type S drywall screws 12" o.c. Joints staggered 24" on opposite sides. <b>Second</b> layer 1/2" proprietary type X gypsum wallboard or gypsum veneer base applied parallel to each side with 1 5/8" Type S drywall screws 30" o.c. and 1 1/2" Type G drywall screws 12" o.c. spaced 1 1/2" from vertical joints. Vertical joints located 8" from studs and staggered 24" on opposite sides. <b>Face</b> layer 1/2" proprietary type X gypsum wallboard or gypsum veneer base applied at right angles to each side with 2 1/4" Type S drywall screws 12" o.c. and 1 1/2" Type G drywall screws midway between studs 1 1/2" above and below horizontal joints. Joints offset 24" from second layer joints.</p> <p>Sound tested with 1 1/2" glass fiber insulation friction fit in stud space. <b>(NLB)</b></p>			
<p style="text-align: center;"><b>PROPRIETARY GYPSUM BOARD</b></p> <p>National Gypsum Company - 1/2" Gold Bond® Brand FIRE-SHIELD C™ Gypsum Board</p>		<p>Thickness: 4 5/8"                      Approx. Weight: 14 psf                      Fire Test: UL R3501, 92NK28896, 9-15-93, UL Design U435;                      Sound Test: WHI-694-0084, 3-16-83, NGC 2636, 7-21-83</p>	
<b>GA FILE NO. WP 2922</b>	<b>PROPRIETARY*</b>	<b>3 HOUR FIRE</b>	<b>50 to 54 STC SOUND</b>
<b>GYPSUM WALLBOARD, STEEL STUDS</b>			
<p><b>Base</b> layer 1/2" proprietary type X gypsum wallboard applied parallel to each side of 1 5/8" steel studs 24" o.c. with 1" Type S drywall screws 36" o.c. <b>Second</b> layer 1/2" proprietary type X gypsum wallboard applied at parallel or at right angles to each side with 1 5/8" Type S drywall screws 24" o.c. <b>Face</b> layer 1/2" proprietary type X gypsum wallboard applied at right angles to each side with 2 1/4" Type S drywall screws 12" o.c. and 1 1/2" Type G drywall screws midway between studs 1 1/2" above and below horizontal joints.</p> <p>Joints staggered 24" each layer and side. Sound tested with 1 1/2" glass fiber insulation friction fit in stud space. <b>(NLB)</b></p>			
<p style="text-align: center;"><b>PROPRIETARY GYPSUM BOARD</b></p> <p>American Gypsum Company LLC - 1/2" FireBloc® Type C                      CertainTeed Gypsum Inc. - 1/2" ProRoc® Type C Gypsum Panels                      CertainTeed Gypsum Canada Inc. - 1/2" ProRoc® Type C Gypsum Panels                      Georgia-Pacific Gypsum LLC - 1/2" ToughRock® Fireguard C™                      Lafarge North America Inc. - 1/2" Firecheck® Type C                      PABCO Gypsum - 1/2" FLAME CURB® Super 'C'™                      Temple-Inland - 1/2" TG-C</p>		<p>Thickness: 4 5/8"                      Approx. Weight: 13 psf                      Fire Test: WHI-495-0804, 11-19-86; UL R7094, 10-24-90, UL Design U435                      Sound Test: WEAL 87-118, 1-22-87</p>	

\*Contact the manufacturer for more detailed information on proprietary products.

WALLS AND INTERIOR PARTITIONS, NONCOMBUSTIBLE				
GA FILE NO. WP 2924	PROPRIETARY*	3 HOUR FIRE	50 to 54 STC SOUND	
GYPSUM WALLBOARD, STEEL STUDS				
<p><b>Base</b> layer 1/2" proprietary type X gypsum wallboard or gypsum veneer base applied parallel to each side of 1 5/8" steel studs 24" o.c. with 1" Type S drywall screws 12" o.c. <b>Second</b> layer 1/2" proprietary type X gypsum wallboard or gypsum veneer base applied parallel to each side with 1 5/8" Type S drywall screws 12" o.c. <b>Face</b> layer 1/2" proprietary type X gypsum wallboard or gypsum veneer base applied at right angles to each side with 2 1/4" Type S drywall screws 12" o.c. and 1 1/2" Type G drywall screws 24" o.c. midway between studs and 1 1/4" above and below horizontal joints.</p> <p>Joints staggered 24" each layer and side. Sound tested with 1 1/2" mineral fiber insulation friction fit in stud space. (NLB)</p>				
<p><b>PROPRIETARY GYPSUM BOARD</b> CertainTeed Gypsum Canada Inc. - 1/2" ProRoc® Type C Gypsum Panels</p>		<p>Thickness: 4 5/8" Approx. Weight: 14 psf Fire Test: ULC 85T381, 11-14-85, ULC Design W418 Sound Test: NRCC 1073-NV, 6-18-86</p>		
GA FILE NO. WP 2925	PROPRIETARY*	3 HOUR FIRE	50 to 54 STC SOUND	
GYPSUM WALLBOARD, STEEL STUDS				
<p><b>Base</b> layer 5/8" proprietary type X gypsum wallboard or gypsum veneer base applied parallel to each side of 1 5/8" steel studs 24" o.c. with 1" Type S drywall screws 24" o.c. <b>Second</b> layer 5/8" proprietary type X gypsum wallboard or gypsum veneer base applied parallel to each side with 1 5/8" Type S drywall screws 24" o.c. <b>Face</b> layer 5/8" proprietary type X gypsum wallboard or gypsum veneer base applied at right angles to each side with 2 5/8" Type S drywall screws 12" o.c.</p> <p>Joints staggered 24" on opposite sides and between layers. Screws offset 6" between layers.</p> <p>Sound tested with 1 5/8" glass fiber insulation friction fit in stud space. (NLB)</p>				
<p><b>PROPRIETARY GYPSUM BOARD</b> National Gypsum Company - 5/8" Gold Bond® Brand FIRE-SHIELD® Gypsum Board</p>		<p>Thickness: 5 3/8" Approx. Weight: 14 psf Fire Test: UL R3501, 03NK32889, 10-30-03, UL Design V438 Sound Test: NGC 2636, 7-21-83</p>		
GA FILE NO. WP 2930	PROPRIETARY*	3 HOUR FIRE		
GYPSUM WALLBOARD, STEEL STUDS				
<p><b>Base</b> layer 3/4" proprietary type X gypsum wallboard applied parallel to each side of 1 5/8" steel studs 24" o.c. with 1 1/4" Type S drywall screws 24" o.c. <b>Face</b> layer 3/4" proprietary type X gypsum wallboard applied parallel or at right angles to each side with 2 1/4" long Type S drywall screws 12" o.c. and 1 1/2" Type G screws midway between studs along horizontal joints.</p> <p>Joints staggered 24" each layer and side. (NLB)</p>				
<p><b>PROPRIETARY GYPSUM BOARD</b> United States Gypsum Company - 3/4" SHEETROCK® Brand ULTRACODE® Core Gypsum Panels</p>		<p>Thickness: 4 5/8" Approx. Weight: 11 psf Fire Test: UL R1319, 92NK18757, 8-17-92, UL Design U435</p>		

\*Contact the manufacturer for more detailed information on proprietary products.

**WALLS AND INTERIOR PARTITIONS, NONCOMBUSTIBLE**

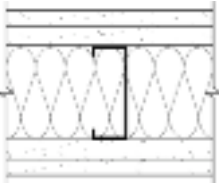
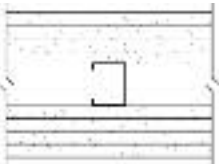
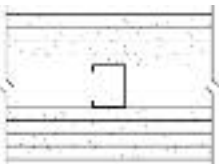
<p><b>GA FILE NO. WP 2931</b></p>	<p><b>PROPRIETARY*</b></p>	<p><b>3 HOUR FIRE</b></p>	
<p><b>GYPSUM WALLBOARD, STRUCTURAL CEMENT PANELS, GLASS FIBER INSULATION, STEEL STUDS</b></p>			<p>Thickness: 6 1/4" Approx. Weight: 10.5 psf Fire Test: UL R25352, 07NK26195, 3-14-08, UL Design V471</p>
<p><b>Base</b> layer 3/4" proprietary structural cement panels applied at right angles to each side of 3 1/2", 18 gage steel studs 16" o.c. with #8 by 1 5/8" self-drilling wing screws 8" o.c. <b>Face</b> layer 5/8" proprietary type X gypsum wallboard applied parallel or at right angles to each side with #6 by 2" Type S-12 drywall screws 8" o.c. Face layer horizontal joints offset 2" from base layer joints. Glass fiber insulation, 3 1/2" thick, friction fit in stud space. <b>(LOAD-BEARING)</b></p> <p>ALTERNATE INSTALLATION: Two layers of proprietary structural cement panels applied at the top of the wall with the <b>base</b> layer a minimum of 12" wide and the <b>face</b> layer a minimum of 10" wide. Remainder of the <b>face</b> layer is 5/8" proprietary type X gypsum wallboard applied as described above. Glass fiber insulation as described above. <b>(LOAD-BEARING)</b></p> <p style="text-align: center;"><b>PROPRIETARY GYPSUM BOARD</b> United States Gypsum Company - 5/8" SHEETROCK® Brand FIRECODE® Core Gypsum Panels</p>			
<p><b>GA FILE NO. WP 2945</b></p>	<p><b>PROPRIETARY*</b></p>	<p><b>4 HOUR FIRE</b></p>	<p><b>60 to 64 FSTC SOUND</b></p>
<p><b>GYPSUM WALLBOARD, STEEL STUDS</b></p>			<p>Thickness: 5 5/8" Approx. Weight: 17 psf Fire Test: UL R1319-138, -139, 5-27-82, UL Design U435 Field Sound Test: SA-830113, 1-13-83</p>
<p><b>Base</b> layer 1/2" proprietary type X gypsum wallboard or gypsum veneer base applied parallel to each side of 1 5/8" steel studs 24" o.c. with 1" Type S drywall screws 48" o.c. <b>Second</b> layer 1/2" proprietary type X gypsum wallboard or gypsum veneer base applied parallel to each side with 1 5/8" Type S drywall screws 48" o.c. <b>Third</b> layer 1/2" proprietary type X gypsum wallboard or gypsum veneer base applied parallel to each side with 2 1/4" Type S drywall screws 48" o.c. <b>Face</b> layer 1/2" proprietary gypsum wallboard or gypsum veneer base applied parallel or at right angles to each side with 2 5/8" Type S drywall screws 12" o.c. and 1 1/2" Type G screws midway between studs 1" above and below horizontal joints for right angle application.</p> <p>Joints staggered 24" each layer and side. Sound tested with 1 1/2" mineral fiber insulation friction fit in stud space. <b>(NLB)</b></p> <p style="text-align: center;"><b>PROPRIETARY GYPSUM BOARD</b> United States Gypsum Company - 1/2" SHEETROCK® Brand FIRECODE® C Core Gypsum Panels</p>			
<p><b>GA FILE NO. WP 2960</b></p>	<p><b>PROPRIETARY*</b></p>	<p><b>4 HOUR FIRE</b></p>	<p><b>55 to 59 STC SOUND</b></p>
<p><b>GYPSUM WALLBOARD, STEEL STUDS</b></p>			<p>Thickness: 5 5/8" Approx. Weight: 19 psf Fire Test: UL R3501, 92NK28896, 9-15-93, UL Design U435; WHI-694-108.1, 6-28-83 Sound Test: NGC 2634, 7-20-83</p>
<p><b>Base</b> layer 1/2" proprietary type X gypsum wallboard or gypsum veneer base applied parallel to each side of 1 5/8" steel studs 24" o.c. with 1" Type S drywall screws 48" o.c. at studs and 24" o.c. at floor and ceiling runners. Joints staggered 24" on opposite sides. <b>Second</b> layer 1/2" proprietary type X gypsum wallboard or gypsum veneer base applied parallel to each side with 1 5/8" Type S drywall screws 12" o.c. Joints aligned with base layer joints. <b>Third</b> layer 1/2" proprietary type X gypsum wallboard or gypsum veneer base applied parallel to each side with 2 1/4" Type S drywall screws 30" o.c. and 1 1/2" Type G drywall screws 12" o.c. spaced 1 1/2" from vertical joints. Vertical joints located 8" from studs and staggered 24" on opposite sides. <b>Face</b> layer 1/2" proprietary type X gypsum wallboard or gypsum veneer base applied at right angles to each side with 2 5/8" Type S drywall screws 12" o.c. and 1 1/2" Type G drywall screws midway between studs 1 1/2" above and below horizontal joints. Joints offset 24" from third layer joints.</p> <p>Sound tested with 1 1/2" glass fiber insulation friction fit in stud space. <b>(NLB)</b></p> <p style="text-align: center;"><b>PROPRIETARY GYPSUM BOARD</b> National Gypsum Company - 1/2" Gold Bond® Brand FIRE-SHIELD C™ Gypsum Board</p>			

\*Contact the manufacturer for more detailed information on proprietary products.



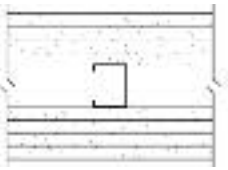
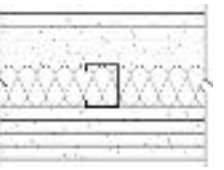
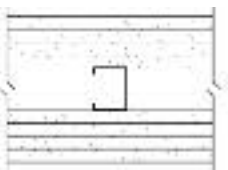
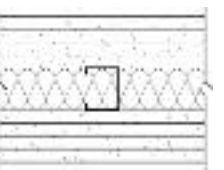
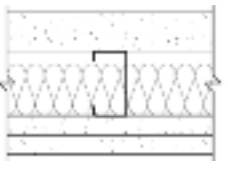
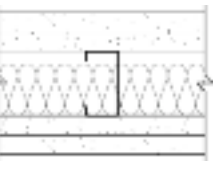

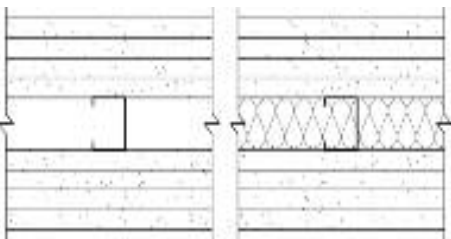
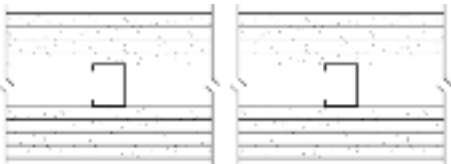
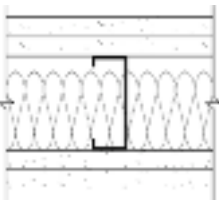

WALLS AND INTERIOR PARTITIONS, NONCOMBUSTIBLE																							
GA FILE NO. WP 2961	PROPRIETARY*	4 HOUR FIRE	55 to 59 STC SOUND																				
GYPSUM WALLBOARD, STEEL STUDS																							
<p><b>Base</b> layer 1/2" proprietary type X gypsum wallboard applied parallel to each side of 15/8" steel studs 24" o.c. with 1" Type S drywall screws 48" o.c. <b>Second</b> layer 1/2" proprietary type X gypsum wallboard applied parallel to each side with 15/8" Type S drywall screws 36" o.c. <b>Third</b> layer 1/2" proprietary type X gypsum wallboard applied parallel or at right angles to each side with 21/4" Type S drywall screws 24" o.c. and 11/2" Type G drywall screws midway between studs 36" o.c. vertically. <b>Face</b> layer 1/2" proprietary type X gypsum wallboard applied at right angles to each side with 21/2" Type S drywall screws 12" o.c. and 11/2" Type G drywall screws midway between studs 11/2" above and below horizontal joints.</p> <p>Joints staggered 24" each layer and side. Sound tested with 11/2" glass fiber insulation friction fit in stud space. (NLB)</p>		<p>Thickness: 55/8"          Approx. Weight: 18 psf          Fire Test: WHI 495-0819, 1-21-87;          UL R7094, 10-24-90,          UL Design U435          Sound Test: WEAL 87-119, 1-23-87</p>																					
<p><b>PROPRIETARY GYPSUM BOARD</b></p> <table border="0"> <tr> <td>American Gypsum Company LLC</td> <td>-</td> <td>1/2" FireBloc® Type C</td> </tr> <tr> <td>CertainTeed Gypsum Inc.</td> <td>-</td> <td>1/2" ProRoc® Type C Gypsum Panels</td> </tr> <tr> <td>CertainTeed Gypsum Canada Inc.</td> <td>-</td> <td>1/2" ProRoc® Type C Gypsum Panels</td> </tr> <tr> <td>Georgia-Pacific Gypsum LLC</td> <td>-</td> <td>1/2" ToughRock® Fireguard C™</td> </tr> <tr> <td>Lafarge North America Inc.</td> <td>-</td> <td>1/2" Firecheck® Type C</td> </tr> <tr> <td>PABCO Gypsum</td> <td>-</td> <td>1/2" FLAME CURB® Super 'C'™</td> </tr> <tr> <td>Temple-Inland</td> <td>-</td> <td>1/2" TG-C</td> </tr> </table>		American Gypsum Company LLC	-	1/2" FireBloc® Type C	CertainTeed Gypsum Inc.	-	1/2" ProRoc® Type C Gypsum Panels	CertainTeed Gypsum Canada Inc.	-	1/2" ProRoc® Type C Gypsum Panels	Georgia-Pacific Gypsum LLC	-	1/2" ToughRock® Fireguard C™	Lafarge North America Inc.	-	1/2" Firecheck® Type C	PABCO Gypsum	-	1/2" FLAME CURB® Super 'C'™	Temple-Inland	-	1/2" TG-C	
American Gypsum Company LLC	-	1/2" FireBloc® Type C																					
CertainTeed Gypsum Inc.	-	1/2" ProRoc® Type C Gypsum Panels																					
CertainTeed Gypsum Canada Inc.	-	1/2" ProRoc® Type C Gypsum Panels																					
Georgia-Pacific Gypsum LLC	-	1/2" ToughRock® Fireguard C™																					
Lafarge North America Inc.	-	1/2" Firecheck® Type C																					
PABCO Gypsum	-	1/2" FLAME CURB® Super 'C'™																					
Temple-Inland	-	1/2" TG-C																					
GA FILE NO. WP 2963	PROPRIETARY*	4 HOUR FIRE	55 to 59 STC SOUND																				
GYPSUM WALLBOARD, STEEL STUDS																							
<p><b>Base</b> layer 1/2" proprietary type X gypsum wallboard or gypsum veneer base applied parallel to each side of 15/8" steel studs 24" o.c. with 1" Type S drywall screws 12" o.c. <b>Second</b> layer 1/2" proprietary type X gypsum wallboard or gypsum veneer base applied parallel to each side with 15/8" Type S drywall screws 12" o.c. <b>Third</b> layer 1/2" proprietary type X gypsum wallboard or gypsum veneer base applied parallel to each side with 2" Type S drywall screws 12" o.c. <b>Face</b> layer 1/2" proprietary type X gypsum wallboard or gypsum veneer base applied at right angles to studs with 25/8" Type S drywall screws 12" o.c. and 11/2" Type G drywall screws 24" o.c. midway between studs and 11/4" above and below horizontal joints.</p> <p>Joints staggered 24" each layer and side. Sound tested with 11/2" thick mineral fiber insulation in stud space. (NLB)</p>		<p>Thickness: 55/8"          Approx. Weight: 19 psf          Fire Test: ULC 85T381, 11-14-85,          ULC Design W418          Sound Test: NRCC 1074-NV, 6-18-86</p>																					
<p><b>PROPRIETARY GYPSUM BOARD</b></p> <table border="0"> <tr> <td>CertainTeed Gypsum Canada Inc.</td> <td>-</td> <td>1/2" ProRoc® Type C Gypsum Panels</td> </tr> </table>		CertainTeed Gypsum Canada Inc.	-	1/2" ProRoc® Type C Gypsum Panels																			
CertainTeed Gypsum Canada Inc.	-	1/2" ProRoc® Type C Gypsum Panels																					
GA FILE NO. WP 2964	PROPRIETARY*	4 HOUR FIRE	55 to 59 FSTC SOUND																				
GYPSUM WALLBOARD, STEEL STUDS, MINERAL FIBER INSULATION																							
<p><b>Base</b> layer 3/4" proprietary type X gypsum wallboard applied parallel to each side of 21/2" steel studs 24" o.c. with 11/4" Type S drywall screws 24" o.c. <b>Face</b> layer 3/4" proprietary type X gypsum wallboard on each side applied parallel or at right angles to each side with 21/4" long Type S drywall screws 12" o.c. and 11/2" Type G drywall screws midway between studs along horizontal joints. 2" proprietary mineral fiber insulation batts, 2.0 pcf, in stud space.</p> <p>Joints staggered 24" each layer and side. (NLB)</p>		<p>Thickness: 51/2"          Approx. Weight: 11 psf          Fire Test: UL R1319, 91NK16132,          11-18-91,          UL Design U490          Field Sound Test: SA-910907, 9-6-91</p>																					
<p><b>PROPRIETARY GYPSUM BOARD</b></p> <table border="0"> <tr> <td>United States Gypsum Company</td> <td>-</td> <td>3/4" SHEETROCK® Brand ULTRACODE® Core Gypsum Panels</td> </tr> </table>		United States Gypsum Company	-	3/4" SHEETROCK® Brand ULTRACODE® Core Gypsum Panels																			
United States Gypsum Company	-	3/4" SHEETROCK® Brand ULTRACODE® Core Gypsum Panels																					

\*Contact the manufacturer for more detailed information on proprietary products.

<b>WALLS AND INTERIOR PARTITIONS, NONCOMBUSTIBLE</b>			
<b>GA FILE NO. WP 2965</b>	<b>PROPRIETARY*</b>	<b>4 HOUR FIRE</b>	<b>55 to 59 STC SOUND</b>
<b>GYPSUM WALLBOARD, STEEL STUDS</b>			
<p><b>Base</b> layer 5/8" proprietary type X gypsum wallboard or gypsum veneer base applied parallel to each side of 15/8" steel studs 24" o.c. with 1" Type S drywall screws 24" o.c. Joints staggered 24" on opposite sides. <b>Second</b> layer 5/8" proprietary type X gypsum wallboard or gypsum veneer base applied parallel to each side with 15/8" Type S drywall screws 24" o.c. <b>Third</b> layer 5/8" proprietary type X gypsum wallboard or gypsum veneer base applied parallel to each side with 25/8" Type S drywall screws 12" o.c. <b>Face</b> layer 5/8" proprietary type X gypsum wallboard or gypsum veneer base applied parallel or at right angles to each side with 3" Type S drywall screws 12" o.c. Screws offset 6" from preceding layer. Joints staggered 24" on opposite sides and between layers.</p> <p>Sound tested with 15/8" glass fiber insulation friction fit in stud space. <b>(NLB)</b></p>		<p>Thickness: 65/8"                      Approx. Weight: 19 psf                      Fire Test: UL R3501, 03NK13364, 1-27-04, UL Design V438                      Sound Test: NGC 2634, 7-20-83</p>	
<b>PROPRIETARY GYPSUM BOARD</b>			
<p>National Gypsum Company - 5/8" Gold Bond® Brand FIRE-SHIELD® Gypsum Board</p>			
<b>GA FILE NO. WP 2970</b>	<b>PROPRIETARY*</b>	<b>4 HOUR FIRE</b>	<b>50 to 54 STC SOUND</b>
<b>GYPSUM WALLBOARD, STEEL STUDS</b>			
<p><b>Base</b> layer 1/2" proprietary type X gypsum wallboard or gypsum veneer base applied parallel to each side of 15/8" steel studs 24" o.c. with 1" Type S drywall screws 48" o.c. at studs and 24" o.c. at floor and ceiling runners. Joints staggered 24" on opposite sides. <b>Second</b> layer 1/2" proprietary type X gypsum wallboard or gypsum veneer base applied parallel to each side with 15/8" Type S drywall screws 12" o.c. Joints aligned with base layer joints. <b>Third</b> layer 1/2" proprietary type X gypsum wallboard or gypsum veneer base applied parallel to each side with 21/4" Type S drywall screws 30" o.c. and 11/2" Type G drywall screws 12" o.c. spaced 11/2" from vertical joints. Vertical joints offset 8" from studs and staggered 24" on opposite sides. <b>Face</b> layer 1/2" proprietary type X gypsum wallboard or gypsum veneer base applied at right angles to each side with 25/8" Type S drywall screws 12" o.c. and 11/2" Type G drywall screws midway between studs 11/2" above and below horizontal joints. Joints offset 24" from third layer joints. <b>(NLB)</b></p>		<p>Thickness: 55/8"                      Approx. Weight: 19 psf                      Fire Test: UL R3501, 92NK28896, 9-15-93, UL Design U435; WHI-694-108.1, 6-28-83                      Sound Test: NGC 2633, 7-18-83</p>	
<b>PROPRIETARY GYPSUM BOARD</b>			
<p>National Gypsum Company - 1/2" Gold Bond® Brand FIRE-SHIELD C™ Gypsum Board</p>			
<b>GA FILE NO. WP 2995</b>	<b>PROPRIETARY*</b>	<b>4 HOUR FIRE</b>	
<b>GYPSUM WALLBOARD, STEEL STUDS, MINERAL FIBER INSULATION</b>			
<p><b>Base</b> layer 3/4" proprietary type X gypsum wallboard or gypsum veneer base applied parallel or at right angles to 31/2" 20 gage steel studs 16" or 24" o.c. with 11/4" Type S-12 drywall screws 24" o.c. <b>Face</b> layer 3/4" proprietary type X gypsum wallboard or veneer base applied parallel or at right angles to studs with 21/4" Type S-12 drywall screws 12" o.c. and 11/2" Type G drywall screws located midway between studs and 1" from gypsum board edges at horizontal joints. 3" mineral fiber insulation, 3.0 pcf, friction fit in stud space.</p> <p>Vertical joints staggered one stud cavity each layer and side, horizontal joints staggered 12" each layer and side. <b>(LOAD-BEARING)</b></p>		<p>Thickness: 61/2"                      Approx. Weight: 14 psf                      Fire Test: UL R1319, 98NK36210, 2-24-99, UL Design U490</p>	
<b>PROPRIETARY GYPSUM BOARD</b>			
<p>United States Gypsum Company - 3/4" SHEETROCK® Brand ULTRACODE® Core Gypsum Panels</p>			

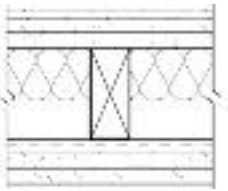
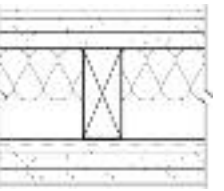
\*Contact the manufacturer for more detailed information on proprietary products.

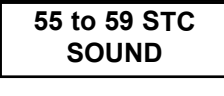
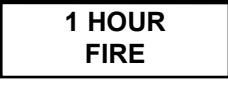
**WALLS AND INTERIOR PARTITIONS, WOOD FRAMED**

GA FILE NO. WP 3010	GENERIC	1 HOUR FIRE	60 to 64 STC SOUND
<p align="center"><b>GYPSUM WALLBOARD, RESILIENT CHANNELS, GLASS FIBER INSULATION, WOOD STUDS</b></p> <p>Resilient channels 24" o.c. attached at right angles to ONE SIDE of 2 x 4 wood studs 16" o.c. with 1" Type S drywall screws. <b>Base</b> layer 5/8" type X gypsum wallboard or gypsum veneer base applied at right angles to channels with 1" Type S drywall screws 12" o.c. <b>Face</b> layer 5/8" type X gypsum wallboard or gypsum veneer base applied at right angles to channels with 3/4" daubs of adhesive 12" o.c. vertically and horizontally.</p> <p>OPPOSITE SIDE: <b>Base</b> layer 5/8" type X gypsum wallboard or gypsum veneer base applied parallel to studs with 5d coated nails, 1 5/8" long, 0.086" shank, 15/64" heads, 32" o.c. <b>Second</b> layer 1/2" type X gypsum wallboard or gypsum veneer base applied parallel to studs with 8d coated nails, 2 3/8" long, 0.113" shank, 9/32" heads, 12" o.c. <b>Face</b> layer 3/8" regular gypsum wallboard applied parallel to studs with 3/4" daubs of adhesive 12" o.c. vertically and horizontally. 2" glass fiber insulation, 0.90 pcf, stapled to three layer side in stud space.</p> <p>Joints staggered 16" each layer and side. <b>(LOAD-BEARING)</b></p>			
<p align="center"><b>GYPSUM WALLBOARD, RESILIENT CHANNELS, GLASS FIBER INSULATION, WOOD STUDS</b></p> <p>Resilient channels 24" o.c. attached at right angles to ONE SIDE of 2 x 4 wood studs 16" o.c. with 1" Type S drywall screws. <b>Base</b> layer 5/8" type X gypsum wallboard or gypsum veneer base applied at right angles to channels with 1" Type S drywall screws 12" o.c. <b>Face</b> layer 5/8" type X gypsum wallboard or gypsum veneer base applied at right angles to channels with 3/4" daubs of adhesive 12" o.c. vertically and horizontally.</p> <p>OPPOSITE SIDE: <b>Base</b> layer 5/8" type X gypsum wallboard or gypsum veneer base applied parallel to studs with 5d coated nails, 1 5/8" long, 0.086" shank, 15/64" heads, 32" o.c. <b>Second</b> layer 1/2" type X gypsum wallboard or gypsum veneer base applied parallel to studs with 8d coated nails, 2 3/8" long, 0.113" shank, 9/32" heads, 12" o.c. <b>Face</b> layer 1/4" regular gypsum wallboard applied parallel to studs with 3/4" daubs of adhesive 12" o.c. vertically and horizontally. 2" glass fiber insulation, 0.90 pcf, stapled to three layer side in stud space.</p> <p>Joints staggered 16" each layer and side. <b>(LOAD-BEARING)</b></p>			
<p align="center"><b>GYPSUM WALLBOARD, RESILIENT CHANNELS, MINERAL FIBER INSULATION, WOOD STUDS</b></p> <p>Resilient channels 24" o.c. attached at right angles to ONE SIDE of 2 x 4 wood studs 16" or 24" o.c. with 1 1/4" Type S drywall screws. One layer 5/8" proprietary type X gypsum wallboard or gypsum veneer base applied parallel to channels with 1" Type S drywall screws 12" o.c. End joints backblocked with resilient channels. 3" mineral fiber insulation, 2.0 or 2.3 pcf, in stud space.</p> <p>OPPOSITE SIDE: One layer 5/8" proprietary type X gypsum wallboard or gypsum veneer base applied at right angles to studs with 1 1/4" Type W drywall screws 12" o.c.</p> <p>Vertical joints staggered 48" on opposite sides. Sound tested with studs 16" o.c. and open face of mineral fiber insulation blankets toward resilient channel-side of stud space. <b>(LOAD-BEARING)</b></p> <p align="center"><b>PROPRIETARY GYPSUM BOARD</b></p> <p>United States Gypsum Company      - 5/8" SHEETROCK® Brand FIRECODE® C Core Gypsum Panels</p>			

*\*Contact the manufacturer for more detailed information on proprietary products.*

**WALLS AND INTERIOR PARTITIONS, WOOD FRAMED**

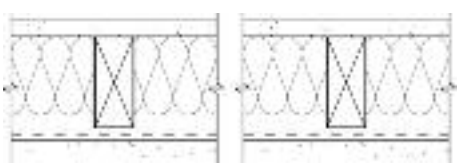
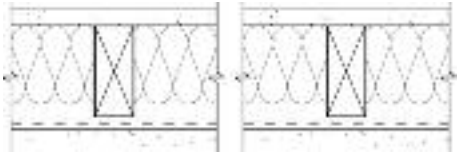
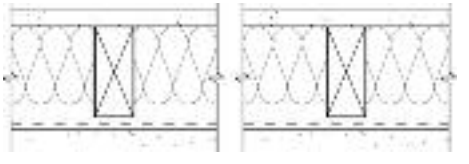
GA FILE NO. WP 3241	PROPRIETARY*	1 HOUR FIRE	50 to 54 STC SOUND																									
<p align="center"><b>GYPSUM WALLBOARD, RESILIENT CHANNELS, MINERAL FIBER INSULATION, WOOD STUDS</b></p> <p>Resilient channels 24" o.c. attached at right angles to ONE SIDE of 2 x 4 wood studs 16" or 24" o.c. with 1 1/4" Type S drywall screws. One layer 5/8" proprietary type X gypsum wallboard or gypsum veneer base applied parallel to channels with 1" Type S drywall screws 12" o.c. End joints backblocked with resilient channels. 3" mineral fiber insulation, 2.0 or 2.3 pcf, in stud space.</p> <p>OPPOSITE SIDE: One layer 5/8" proprietary type X gypsum wallboard or gypsum veneer base applied at right angles to studs with 1 1/4" Type W drywall screws 12" o.c.</p> <p>Vertical joints staggered 48" on opposite sides. Sound tested with studs 16" o.c. and open face of mineral fiber insulation blankets toward resilient channel-side of stud space. <b>(LOAD-BEARING)</b></p> <p align="center"><b>PROPRIETARY GYPSUM BOARD</b></p> <table border="0"> <tr> <td>American Gypsum Company LLC</td> <td>-</td> <td>5/8" FireBloc® Type C</td> </tr> <tr> <td>CertainTeed Gypsum Inc.</td> <td>-</td> <td>5/8" ProRoc® Type C Gypsum Panels</td> </tr> <tr> <td>CertainTeed Gypsum Canada Inc.</td> <td>-</td> <td>5/8" ProRoc® Type C Gypsum Panels</td> </tr> <tr> <td>Georgia-Pacific Gypsum LLC</td> <td>-</td> <td>5/8" ToughRock® Fireguard C™</td> </tr> <tr> <td>Lafarge North America Inc.</td> <td>-</td> <td>5/8" Firecheck® Type C</td> </tr> <tr> <td>National Gypsum Company</td> <td>-</td> <td>5/8" Gold Bond® Brand FIRE-SHIELD C™ Gypsum Board</td> </tr> <tr> <td>PABCO Gypsum</td> <td>-</td> <td>5/8" FLAME CURB® Super 'C'™</td> </tr> <tr> <td>Temple-Inland</td> <td>-</td> <td>5/8" TG-C</td> </tr> </table>		American Gypsum Company LLC	-	5/8" FireBloc® Type C	CertainTeed Gypsum Inc.	-	5/8" ProRoc® Type C Gypsum Panels	CertainTeed Gypsum Canada Inc.	-	5/8" ProRoc® Type C Gypsum Panels	Georgia-Pacific Gypsum LLC	-	5/8" ToughRock® Fireguard C™	Lafarge North America Inc.	-	5/8" Firecheck® Type C	National Gypsum Company	-	5/8" Gold Bond® Brand FIRE-SHIELD C™ Gypsum Board	PABCO Gypsum	-	5/8" FLAME CURB® Super 'C'™	Temple-Inland	-	5/8" TG-C			<p>Thickness: 5 3/8"                  Approx. Weight: 7 psf                  Fire Test: Based on UL R3660-7, 11-12-87; UL R2717-61, 8-18-87; UL Design U311                  Sound Test: Estimated</p>
American Gypsum Company LLC	-	5/8" FireBloc® Type C																										
CertainTeed Gypsum Inc.	-	5/8" ProRoc® Type C Gypsum Panels																										
CertainTeed Gypsum Canada Inc.	-	5/8" ProRoc® Type C Gypsum Panels																										
Georgia-Pacific Gypsum LLC	-	5/8" ToughRock® Fireguard C™																										
Lafarge North America Inc.	-	5/8" Firecheck® Type C																										
National Gypsum Company	-	5/8" Gold Bond® Brand FIRE-SHIELD C™ Gypsum Board																										
PABCO Gypsum	-	5/8" FLAME CURB® Super 'C'™																										
Temple-Inland	-	5/8" TG-C																										
GA FILE NO. WP 3242	GENERIC	1 HOUR FIRE	50 to 54 STC SOUND																									
<p align="center"><b>GYPSUM WALLBOARD, RESILIENT CHANNELS, MINERAL OR GLASS FIBER INSULATION, WOOD STUDS</b></p> <p>Resilient channels 16" o.c. attached at right angles to ONE SIDE of 2 x 4 wood studs 24" o.c. with 1 1/4" Type S drywall screws. One layer 5/8" type X gypsum wallboard or gypsum veneer base applied at right angles to channels with 1" Type S drywall screws 8" o.c. with vertical joints located midway between studs. 3" mineral or glass fiber insulation in stud space.</p> <p>OPPOSITE SIDE: One layer 5/8" type X gypsum wallboard or gypsum veneer base applied parallel or at right angles to studs with 6d cement coated nails, 1 7/8" long, 0.0915" shank, 15/64" heads, 7" o.c.</p> <p>Vertical joints staggered 24" on opposite sides. <b>(LOAD-BEARING)</b></p>				<p>Thickness: 5 3/8"                  Approx. Weight: 7 psf                  Fire Test: Based on UL R14196, 05NK05371, 2-15-05, UL Design U309                  Sound Test: NRCC TL-93-098, IRC-IR-761, 3/98</p>																								
GA FILE NO. WP 3243	GENERIC	1 HOUR FIRE	50 to 54 STC SOUND																									
<p align="center"><b>GYPSUM WALLBOARD, RESILIENT CHANNELS, MINERAL OR GLASS FIBER INSULATION, WOOD STUDS</b></p> <p>Resilient channels 24" o.c. attached at right angles to ONE SIDE of 2 x 4 wood studs 24" o.c. with 1 1/4" Type S drywall screws. One layer 5/8" type X gypsum wallboard or gypsum veneer base applied at right angles to channels with 1" Type S drywall screws 8" o.c. with vertical joints located midway between studs. 3" mineral or glass fiber insulation in stud space.</p> <p>OPPOSITE SIDE: One layer 5/8" type X gypsum wallboard or gypsum veneer base applied parallel or at right angles to studs with 6d cement coated nails, 1 7/8" long, 0.0915" shank, 15/64" heads, 7" o.c.</p> <p>Vertical joints staggered 24" on opposite sides. <b>(LOAD-BEARING)</b></p>				<p>Thickness: 5 3/8"                  Approx. Weight: 7 psf                  Fire Test: Based on UL R14196, 05NK05371, 2-15-05, UL Design U309                  Sound Test: NRCC TL-93-103, IRC-IR-761, 3/98</p>																								

\*Contact the manufacturer for more detailed information on proprietary products.

## WALLS AND INTERIOR PARTITIONS, WOOD FRAMED

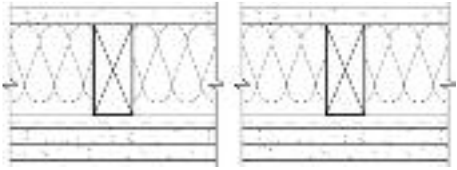
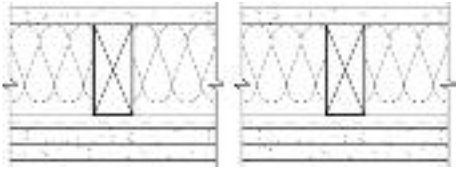
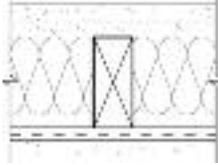
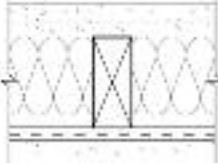
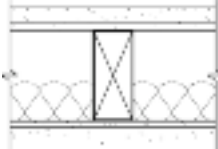
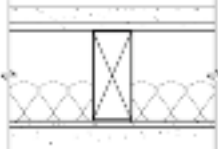
GA FILE NO. WP 3244	GENERIC	1 HOUR FIRE	50 to 54 STC SOUND										
<p style="text-align: center;"><b>GYPSUM WALLBOARD, RESILIENT CHANNELS, MINERAL OR GLASS FIBER INSULATION, WOOD STUDS</b></p> <p>Resilient channels 16" o.c. attached at right angles to ONE SIDE of 2 x 4 wood studs 16" o.c. with 1 1/4" Type S drywall screws. <b>Base</b> layer 5/8" type X gypsum wallboard or gypsum veneer base applied at right angles to channels with 1" Type S drywall screws 8" o.c. with vertical joints located midway between studs. <b>Face</b> layer 5/8" type X gypsum wallboard or gypsum veneer base applied at right angles to channels with 1 5/8" Type S drywall screws 8" o.c. Face layer joints offset 16" from base layer joints. 3" mineral or glass fiber insulation in stud space.</p> <p>OPPOSITE SIDE: One layer 5/8" type X gypsum wallboard or gypsum veneer base applied parallel or at right angles to studs with 6d cement coated nails, 1 7/8" long, 0.0915" shank, 15/64" heads, 7" o.c.</p> <p>Vertical joints staggered 16" on opposite sides. <b>(LOAD-BEARING)</b></p>													
		Thickness: 6" Approx. Weight: 9 psf Fire Test: Based on UL R14196, 05NK05371, 2-15-05, UL Design U305 Sound Test: NRCC TL-93-118, IRC-IR-761, 3/98											
GA FILE NO. WP 3245	GENERIC	1 HOUR FIRE	50 to 54 STC SOUND										
<p style="text-align: center;"><b>GYPSUM WALLBOARD, RESILIENT CHANNELS, MINERAL OR GLASS FIBER INSULATION, WOOD STUDS</b></p> <p>Resilient channels 24" o.c. attached at right angles to ONE SIDE of 2 x 4 wood studs 16" o.c. with 1 1/4" Type S drywall screws. One layer 5/8" type X gypsum wallboard or gypsum veneer base applied at right angles to channels with 1" Type S drywall screws 8" o.c. with vertical joints located midway between studs. 3" mineral or glass fiber insulation in stud space.</p> <p>OPPOSITE SIDE: <b>Base</b> layer 5/8" type X gypsum wallboard or gypsum veneer base applied parallel or at right angles to studs with 6d cement coated nails, 1 7/8" long, 0.0915" shank, 15/64" heads, 7" o.c. <b>Face</b> layer 5/8" type X gypsum wallboard or gypsum veneer base applied at parallel or at right angles to studs with 8d cement coated nails, 2 3/8" long, 8" o.c. Face layer joints offset 16" from base layer joints.</p> <p>Vertical joints staggered 16" on opposite sides. <b>(LOAD-BEARING)</b></p>													
		Thickness: 6" Approx. Weight: 9 psf Fire Test: Based on UL R14196, 05NK05371, 2-15-05, UL Design U305 Sound Test: NRCC TL-93-116, IRC-IR-761, 3/98											
GA FILE NO. WP 3260	PROPRIETARY*	1 HOUR FIRE	50 to 54 STC SOUND										
<p style="text-align: center;"><b>GYPSUM WALLBOARD, GLASS FIBER INSULATION, WOOD STUDS</b></p> <p><b>Base</b> layer 1/4" proprietary gypsum wallboard applied parallel to each side of 2 x 4 wood studs 16" o.c. with 4d coated nails, 1 1/2" long, 0.099" shank, 1/4" heads, 12" o.c. <b>Face</b> layer 5/8" proprietary type X gypsum wallboard or gypsum veneer base applied parallel to each side with 6" wide strips of laminating compound along the edges and centerline of each board and 6d coated nails, 1 7/8" long, 0.0915" shank, 1/4" heads, 16" o.c. at top and bottom plates only. 1 1/2" glass fiber insulation, 0.8 pcf, in stud space.</p> <p>Joints staggered 16" each layer and side. <b>(LOAD-BEARING)</b></p>													
<p style="text-align: center;"><b>PROPRIETARY GYPSUM BOARD</b></p> <table style="width: 100%; border: none;"> <tr> <td style="width: 30%;">Georgia-Pacific Gypsum LLC</td> <td style="width: 70%;">- 1/4" ToughRock® Sound Deadening Board</td> </tr> <tr> <td></td> <td style="text-align: center;">- 5/8" ToughRock® Fireguard C™</td> </tr> <tr> <td>Lafarge North America Inc.</td> <td style="text-align: center;">- 1/4" Soundcheck®</td> </tr> <tr> <td></td> <td style="text-align: center;">- 5/8" Firecheck® Type C</td> </tr> <tr> <td>National Gypsum Company</td> <td style="text-align: center;">- 5/8" Gold Bond® Brand FIRE-SHIELD C™ Gypsum Board</td> </tr> </table>	Georgia-Pacific Gypsum LLC	- 1/4" ToughRock® Sound Deadening Board		- 5/8" ToughRock® Fireguard C™	Lafarge North America Inc.	- 1/4" Soundcheck®		- 5/8" Firecheck® Type C	National Gypsum Company	- 5/8" Gold Bond® Brand FIRE-SHIELD C™ Gypsum Board		Thickness: 5 3/8" Approx. Weight: 9 psf Fire Test: See WP 3340 (UL R2717-52, 9-9-68, UL Design U312; ULC Design W300) Sound Test: G&H BW-35ST, 4-16-69	
Georgia-Pacific Gypsum LLC	- 1/4" ToughRock® Sound Deadening Board												
	- 5/8" ToughRock® Fireguard C™												
Lafarge North America Inc.	- 1/4" Soundcheck®												
	- 5/8" Firecheck® Type C												
National Gypsum Company	- 5/8" Gold Bond® Brand FIRE-SHIELD C™ Gypsum Board												

*\*Contact the manufacturer for more detailed information on proprietary products.*

**WALLS AND INTERIOR PARTITIONS, WOOD FRAMED**

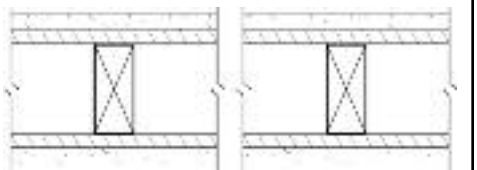
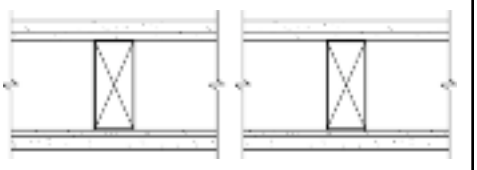
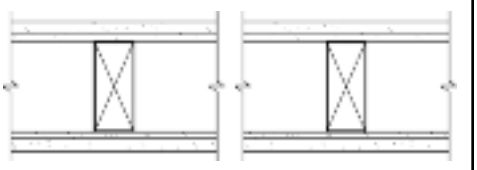
GA FILE NO. WP 3330	GENERIC	1 HOUR FIRE	45 to 49 STC SOUND																								
<p align="center"><b>GYPSUM WALLBOARD, WOOD FIBERBOARD, WOOD STUDS</b></p> <p><b>Base</b> layer 1/2" wood fiberboard, 0.82 psf, applied parallel to each side of 2 x 4 wood studs 16" o.c. with 5d coated nails, 17/8" long, 0.0915" shank, 1/4" heads, 24" o.c. at vertical joints and intermediate studs and 16" o.c. at top and bottom plates. <b>Face</b> layer 5/8" type X gypsum wallboard or gypsum veneer base applied parallel to each side with 6" wide strips of 1/2" thick beads of laminating adhesive along the perimeter and centerline of each board and 8d coated nails, 2 1/2" long, 0.131" shank, 9/32" heads, 12" o.c. to top and bottom plates, 24" o.c. at vertical joints, and at third-points at intermediate studs.</p> <p>Joints staggered 24" each layer and side. <b>(LOAD-BEARING)</b></p>		 <p>Thickness: 5/8"                      Approx. Weight: 8 psf                      Fire Test: OSU T-3054, 4-3-65                      Sound Test: OR 64-73, 9-23-64</p>																									
GA FILE NO. WP 3340	PROPRIETARY*	1 HOUR FIRE	45 to 49 STC SOUND																								
<p align="center"><b>GYPSUM WALLBOARD, WOOD STUDS</b></p> <p><b>Base</b> layer 1/4" proprietary gypsum wallboard applied parallel to each side of 2 x 4 wood studs 16" o.c. with 4d coated nails, 1 1/2" long, 0.099" shank, 1/4" heads, 12" o.c. Joints staggered 16" on opposite sides. <b>Face</b> layer 1/2" proprietary type X plain or predecorated gypsum wallboard or gypsum veneer base applied parallel to each side with 1/2" beads of adhesive 16" o.c. and 6d coated nails, 17/8" long, 0.0915" shank, 1/4" heads, 6" o.c. at top and bottom plates only. Joints offset 24" from base layer joints. <b>(LOAD-BEARING)</b></p> <p align="center"><b>PROPRIETARY GYPSUM BOARD</b></p> <table border="0"> <tr> <td>American Gypsum Company LLC</td> <td>-</td> <td>1/2" FireBloc® Type C</td> </tr> <tr> <td>Georgia-Pacific Gypsum LLC</td> <td>-</td> <td>1/4" ToughRock® Sound Deadening Board</td> </tr> <tr> <td></td> <td>-</td> <td>1/2" ToughRock® Fireguard C™</td> </tr> <tr> <td>Lafarge North America Inc.</td> <td>-</td> <td>1/4" Soundcheck®</td> </tr> <tr> <td></td> <td>-</td> <td>1/2" Firecheck® Type C</td> </tr> <tr> <td>National Gypsum Company</td> <td>-</td> <td>1/2" Gold Bond® Brand FIRE-SHIELD C™ Gypsum Board</td> </tr> <tr> <td>Temple-Inland</td> <td>-</td> <td>1/4" Temple-4 Sound Deadening Board</td> </tr> <tr> <td></td> <td>-</td> <td>1/2" TG-C</td> </tr> </table>		American Gypsum Company LLC	-	1/2" FireBloc® Type C	Georgia-Pacific Gypsum LLC	-	1/4" ToughRock® Sound Deadening Board		-	1/2" ToughRock® Fireguard C™	Lafarge North America Inc.	-	1/4" Soundcheck®		-	1/2" Firecheck® Type C	National Gypsum Company	-	1/2" Gold Bond® Brand FIRE-SHIELD C™ Gypsum Board	Temple-Inland	-	1/4" Temple-4 Sound Deadening Board		-	1/2" TG-C	 <p>Thickness: 5 1/8"                      Approx. Weight: 8 psf                      Fire Test: UL R2717-52, 9-9-68, UL Design U312; ULC Design W300                      Sound Test: G&amp;H BW-27FT, 7-13-67</p>	
American Gypsum Company LLC	-	1/2" FireBloc® Type C																									
Georgia-Pacific Gypsum LLC	-	1/4" ToughRock® Sound Deadening Board																									
	-	1/2" ToughRock® Fireguard C™																									
Lafarge North America Inc.	-	1/4" Soundcheck®																									
	-	1/2" Firecheck® Type C																									
National Gypsum Company	-	1/2" Gold Bond® Brand FIRE-SHIELD C™ Gypsum Board																									
Temple-Inland	-	1/4" Temple-4 Sound Deadening Board																									
	-	1/2" TG-C																									
GA FILE NO. WP 3341	GENERIC	1 HOUR FIRE	45 to 49 STC SOUND																								
<p align="center"><b>GYPSUM WALLBOARD, WOOD STUDS</b></p> <p><b>Base</b> layer 1/4" gypsum wallboard applied parallel to each side of 2 x 4 wood studs 16" o.c. with 4d coated nails, 1 1/2" long, 0.099" shank, 1/4" heads, 12" o.c. Joints staggered 16" on opposite sides. <b>Face</b> layer 1/2" type X plain or predecorated gypsum wallboard or gypsum veneer base applied parallel to each side with 1/4" beads of adhesive 2" o.c. and 6d coated nails, 17/8" long, 0.0915" shank, 1/4" heads, 6" o.c. at top and bottom plates only. Offset joints 24" from base layer joints. <b>(LOAD-BEARING)</b></p>		 <p>Thickness: 5 1/8"                      Approx. Weight: 7 psf                      Fire Test: FM WP-147, 1-2-69                      Sound Test: NGC 2321, 8-29-68</p>																									

\*Contact the manufacturer for more detailed information on proprietary products.

**WALLS AND INTERIOR PARTITIONS, WOOD FRAMED**

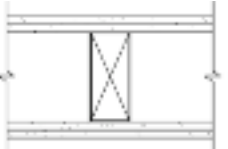
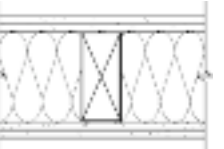
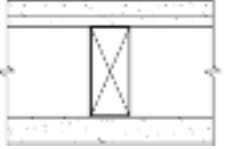
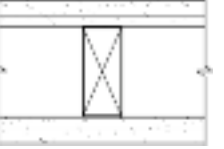
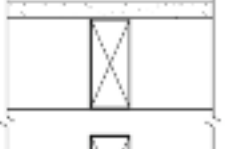
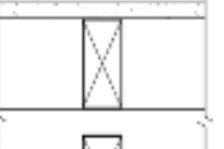
GA FILE NO. WP 3343	PROPRIETARY*	1 HOUR FIRE	45 to 49 STC SOUND
<p align="center"><b>GYPSUM PANEL PRODUCT, WOOD STUDS</b></p> <p>One layer 5/8" proprietary gypsum panel product applied parallel to each side of 2 x 4 wood studs 16" o.c. with 6d coated nails, 17/8" long, 0.0915" shank, 1/4" heads, 7" o.c.</p> <p>Joints staggered 16" on opposite sides. Sound tested with 3 1/2" glass fiber insulation friction fit in stud space. <b>(LOAD-BEARING)</b></p> <p align="center"><b>PROPRIETARY GYPSUM PANEL PRODUCT</b></p> <p>Temple-Inland - 5/8" ComfortGuard Sound Deadening Gypsum Board</p>			
		<p>Thickness: 47/8"</p> <p>Approx. Weight: 7 psf</p> <p>Fire Test: ITS 3152726, 9-8-08</p> <p>Sound Test: OL 08-0905, 9-3-08</p>	
GA FILE NO. WP 3360	GENERIC	1 HOUR FIRE	45 to 49 FSTC SOUND
<p align="center"><b>GYPSUM WALLBOARD, WOOD STUDS</b></p> <p><b>Base</b> layer 3/8" gypsum wallboard or gypsum veneer base applied parallel to each side of 2 x 4 wood studs 16" o.c. with 5d coated nails, 1 3/4" long, 0.082" shank, 7/32" heads, 12" o.c. <b>Face</b> layer 5/8" type X gypsum wallboard or gypsum veneer base applied parallel to each side with 6" wide strips of laminating compound combed along edges and intermediate studs and 6d finish nails, 2" long, 0.0915" shank, 0.135" heads driven at 45° angle 24" o.c. at intermediate studs.</p> <p>Joints staggered 16" o.c. each layer and side. <b>(LOAD-BEARING)</b></p>			
		<p>Thickness: 5 5/8"</p> <p>Approx. Weight: 8 psf</p> <p>Fire Test: UC, 2-4-65</p> <p>Field Sound Test: ACI 7-1152004a, 12-21-64</p>	
GA FILE NO. WP 3370	GENERIC	1 HOUR FIRE	45 to 49 STC SOUND
<p align="center"><b>GYPSUM WALLBOARD, WOOD STUDS</b></p> <p>One layer 5/8" type X gypsum wallboard or gypsum veneer base applied parallel or at right angles to each side of double row of 2 x 4 wood studs 16" o.c. on separate plates 1" apart with 6d coated nails, 17/8" long, 0.0915" shank, 1/4" heads, 7" o.c.</p> <p>Joints staggered 16" on opposite sides. Horizontal bracing required at mid-height. <b>(LOAD-BEARING)</b></p>			
		<p>Thickness: 9 1/2"</p> <p>Approx. Weight: 8 psf</p> <p>Fire Test: See WP 3605 (UL R1319-4, 6, 6-17-52; UL R2717-39, 1-20-66; UL R3501-52, 3-15-66, UL Design U305; ULC Design W301); UL R4024, 10-31-68</p> <p>Sound Test: NRCC TL-93-261, IRC-IR-761, 3/98</p>	

\*Contact the manufacturer for more detailed information on proprietary products.

**WALLS AND INTERIOR PARTITIONS, WOOD FRAMED**

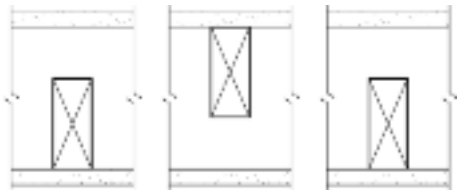
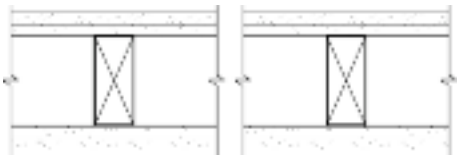
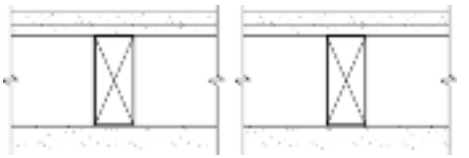
GA FILE NO. WP 3380	GENERIC	1 HOUR FIRE	40 to 44 STC SOUND
<p align="center"><b>GYPSUM WALLBOARD, WOOD STUDS</b></p>			
<p>One layer 5/8" type X gypsum wallboard or gypsum veneer base applied parallel or at right angles to each side of 2 x 4 wood studs 16" o.c. staggered 8" o.c. on 2 x 6 wood plates with 6d coated nails, 17/8" long, 0.0915" shank, 1/4" heads, 7" o.c.</p> <p>Joints staggered 24" on opposite sides. Horizontal bracing required at mid-height. <b>(LOAD-BEARING)</b></p>			
		<p>Thickness: 7<sup>3</sup>/<sub>4</sub>"                      Approx. Weight: 8 psf                      Fire Test: See WP 3605                      (UL R1319-4, -6, 6-17-52;                      UL R2717-39, 1-20-66;                      UL R3501-52, 3-15-66,                      UL Design U305;                      ULC Design W301);                      UL R4024, 10-31-68                      Sound Test: NRCC TL-93-254,                      IRC-IR-761, 3/98</p>	
GA FILE NO. WP 3430	GENERIC	1 HOUR FIRE	40 to 44 STC SOUND
<p align="center"><b>GYPSUM LATH, GYPSUM PLASTER, WOOD STUDS</b></p>			
<p>1/2" 1:2 gypsum-sand plaster applied over 3/8" plain gypsum lath applied at right angles to each side of 2 x 4 wood studs 16" o.c. with 13 gage blued lath nails, 11/8" long, 0.0915" shank, 19/64" heads, 4" o.c. <b>(LOAD-BEARING)</b></p>			
		<p>Thickness: 5<sup>3</sup>/<sub>8</sub>"                      Approx. Weight: 15 psf                      Fire Test: OSU T-948, 7-17-58;                      OSU T-1380, 7-5-60                      Sound Test: RAL TL58-60, 8-7-58</p>	
GA FILE NO. WP 3431	GENERIC	1 HOUR FIRE	40 to 44 STC SOUND
<p align="center"><b>GYPSUM LATH, GYPSUM PLASTER, WOOD STUDS</b></p>			
<p>1/2" 1:2 gypsum-sand plaster applied over 3/8" type X gypsum lath applied at right angles to each side of 2 x 4 wood studs 16" o.c. with 13 gage blued lath nails, 11/8" long, 0.0915" shank, 19/64" heads, 5" o.c. <b>(LOAD-BEARING)</b></p>			
		<p>Thickness: 5<sup>3</sup>/<sub>8</sub>"                      Approx. Weight: 15 psf                      Fire Test: OSU T-1488, 12-60                      Sound Test: RAL TL58-60, 8-7-58</p>	





WALLS AND INTERIOR PARTITIONS, WOOD FRAMED			
<p><b>GA FILE NO. WP 3436</b></p>	<p><b>GENERIC</b></p>	<p><b>1 HOUR FIRE</b></p>	<p><b>40 to 44 STC SOUND</b></p>
<p><b>GYPSUM LATH, GYPSUM PLASTER, RESILIENT CHANNELS, WOOD STUDS</b></p>			
<p>Resilient channels 16" o.c. attached at right angles to each side of 2 x 4 wood studs 16" o.c. with 5d coated nails, 1<sup>5</sup>/<sub>8</sub>" long, 0.072" shank, 7/32" heads. 1/2" x 3" strips of gypsum wallboard applied on each side at top plate and at mid-height with 5d nails. 1/2" 1:2 or 1:3 gypsum-sand plaster applied over 3/8" type X gypsum lath attached at right angles to channels with 3/4" Type S drywall screws, 3 per lath at each channel, and 5d coated nails, 1<sup>5</sup>/<sub>8</sub>" long, 0.072" shank, 7/32" heads, 3 per lath at top plate.</p>		<p>Thickness: 57/8"                  Approx. Weight: 15 psf                  Fire Test: UC, 2-15-66                  Sound Test: RAL TL66-299, 8-24-66</p>	
<p>Horizontal joints staggered 16" and vertical joints 6" on opposite sides. <b>(LOAD-BEARING)</b></p>			
<p><b>GA FILE NO. WP 3441</b></p>	<p><b>PROPRIETARY*</b></p>	<p><b>1 HOUR FIRE</b></p>	<p><b>40 to 44 FSTC SOUND</b></p>
<p><b>GYPSUM WALLBOARD, MINERAL FIBER INSULATION, CEMENTITIOUS BACKER UNIT, CERAMIC TILE, WOOD STUDS</b></p>			
<p>One layer 1/2" thick proprietary cementitious backer unit applied parallel or at right angles to 2 x 4 wood studs 16" o.c. with 1 1/2" galvanized roofing nails or 1 5/8" wafer head screws 8" o.c. Ceramic tile, 1/4" thick, joints grouted, installed with latex-modified portland cement mortar or ANSI A136.1 Type I organic adhesive. 3 1/2" mineral fiber insulation, 2.0 pcf, friction fit in stud space.</p>		<p>Thickness: 5 1/8"                  Approx. Weight: 13 psf                  Fire Test: UL R11270, 4-19-85,                  UL Design U329                  Field Sound Test: USG 840314, 3-12-84;                  USG 840404, 4-4-84</p>	
<p>OPPOSITE SIDE: One layer 5/8" proprietary type X gypsum wallboard applied parallel or at right angles to studs with 6d cement coated nails, 17/8" long, 0.0915" shank, 1/4" heads, 7" o.c. As an alternate, one layer 1/2" thick proprietary cementitious backer unit applied with 1 1/2" galvanized roofing nails or 1 5/8" wafer head screws 8" o.c. and faced with ceramic tile. (FSTC 37 when alternate is used.) <b>(LOAD-BEARING)</b></p>			
<p><b>PROPRIETARY GYPSUM BOARD</b></p> <ul style="list-style-type: none"> <li>American Gypsum Company LLC - 5/8" FireBloc® Type X</li> <li>Lafarge North America Inc. - 5/8" Firecheck® Type X</li> <li>Temple-Inland - 5/8" Type X</li> <li>United States Gypsum Company - 5/8" SHEETROCK® Brand FIRECODE® Core Gypsum Panels</li> </ul>			
<p><b>GA FILE NO. WP 3510</b></p>	<p><b>GENERIC</b></p>	<p><b>1 HOUR FIRE</b></p>	<p><b>35 to 39 STC SOUND</b></p>
<p><b>GYPSUM WALLBOARD, WOOD STUDS</b></p>			
<p>One layer 5/8" type X gypsum wallboard or gypsum veneer base applied parallel or at right angles to each side of 2 x 4 wood studs 24" o.c. with 6d coated nails, 17/8" long, 0.0915" shank, 1/4" heads, 7" o.c.</p>		<p>Thickness: 47/8"                  Approx. Weight: 7 psf                  Fire Test: UL R3501-47, -48, 9-17-65,                  UL Design U309;                  UL R1319-129, 7-22-70,                  UL Design U314                  Sound Test: NGC 2404, 10-14-70</p>	
<p>Joints staggered 24" on opposite sides. <b>(LOAD-BEARING)</b></p>			

\*Contact the manufacturer for more detailed information on proprietary products.

**WALLS AND INTERIOR PARTITIONS, WOOD FRAMED**

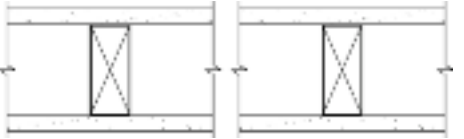
GA FILE NO. WP 3514	GENERIC	1 HOUR FIRE	35 to 39 STC SOUND
<p align="center"><b>GYPSUM WALLBOARD, WOOD STUDS</b></p>			
<p>One layer 5/8" type X gypsum wallboard or gypsum veneer base applied parallel or at right angles to each side of 2 x 4 wood studs 16" o.c. with 1 1/4" Type W drywall screws 12" o.c.                      Joints staggered 16" on opposite sides. <b>(LOAD-BEARING)</b></p>			
		<p>Thickness: 4 3/4"                      Approx. Weight: 7 psf                      Fire Test: SWRI 01-4511-619[1], 3-94                      Sound Test: See WP 3520 (G&amp;H NG-246FT, 7-2-65)</p>	
GA FILE NO. WP 3520	GENERIC	1 HOUR FIRE	35 to 39 STC SOUND
<p align="center"><b>GYPSUM WALLBOARD, WOOD STUDS</b></p>			
<p>One layer 5/8" type X plain or predecorated gypsum wallboard applied parallel to each side of 2 x 4 wood studs 24" o.c. with 6d coated nails, 1 7/8" long, 0.0915" shank, 1/4" heads, 7" o.c. at joints and top and bottom plates and 3/8" beads of adhesive at intermediate studs.                      Joints staggered 24" on opposite sides. <b>(LOAD-BEARING)</b></p>			
		<p>Thickness: 4 7/8"                      Approx. Weight: 7 psf                      Fire Test: FM WP 90, 8-21-67                      Sound Test: G&amp;H NG-246FT, 7-2-65</p>	
GA FILE NO. WP 3605	GENERIC	1 HOUR FIRE	30 to 34 STC SOUND
<p align="center"><b>GYPSUM WALLBOARD, WOOD STUDS</b></p>			
<p>One layer 5/8" type X plain or predecorated gypsum wallboard, water-resistant gypsum backing board, or gypsum veneer base applied parallel or at right angles to each side of 2 x 4 wood studs 16" o.c. with 6d coated nails, 1 7/8" long, 0.0915" shank, 1/4" heads, 7" o.c. Joints of square edge, bevel edge or predecorated wallboard may be left exposed.                      Joints staggered 16" on opposite sides. <b>(LOAD-BEARING)</b></p>			
		<p>Thickness: 4 7/8"                      Approx. Weight: 7 psf                      Fire Test: UL R1319-4, -6, 6-17-52; UL R2717-39, 1-20-66; UL R3501-52, 3-15-66, UL Design U305; ULC Design W301                      Sound Test: OR 64-8, 2-4-64</p>	

WALLS AND INTERIOR PARTITIONS, WOOD FRAMED			
GA FILE NO. WP 3615	PROPRIETARY*	1 HOUR FIRE	30 to 34 STC SOUND
<p align="center"><b>GLASS MAT GYPSUM SUBSTRATE, WOOD STUDS</b></p>			
<p>One layer 5/8" proprietary type X glass mat water-resistant gypsum backing board applied parallel or at right angles to 2 x 4 wood studs 16" o.c. with phosphate coated nails, 17/8" long, 1/4" diameter cupped heads, 8" o.c.</p>		<p>Thickness: 43/4"            Approx. Weight: 7 psf            Fire Test: WHI-495-0853, 5-14-87;            WHI-495-0854, 5-15-87            Sound Test: See WP 3605            (OR 64-8, 2-4-64)</p>	
<p>Joints staggered 16" on opposite sides and covered with 10x10 mesh glass tape and tile adhesive. <b>(LOAD-BEARING)</b></p>			
<p align="center"><b>PROPRIETARY GYPSUM PANEL PRODUCT</b></p>			
<p>Georgia-Pacific Gypsum LLC - 5/8" DensShield® Fireguard®</p>			
GA FILE NO. WP 3620	GENERIC	1 HOUR FIRE	30 to 34 STC SOUND
<p align="center"><b>GYPSUM VENEER BASE, GYPSUM VENEER PLASTER, WOOD STUDS</b></p>			
<p>One layer 1/2" type X gypsum veneer base applied at right angles to each side of 2 x 4 wood studs 16" o.c. with 5d etched nails, 13/4" long, 0.099" shank, 1/4" heads, 8" o.c. 1/16" gypsum veneer plaster applied over each face.</p>		<p>Thickness: 47/8"            Approx. Weight: 7 psf            Fire Test: UC, 1-12-66            Sound Test: G&amp;H IBI-35FT, 5-26-64</p>	
<p>Vertical joints staggered 16" and horizontal joints 12" on opposite sides. Sound tested without gypsum veneer plaster. <b>(LOAD-BEARING)</b></p>			
GA FILE NO. WP 3640	GENERIC	1 HOUR FIRE	
<p align="center"><b>GYPSUM WALLBOARD, WOOD STUDS</b></p>			
<p>One layer 5/8" type X gypsum wallboard or gypsum veneer base applied parallel or at right angles to each side of either 2 x 3 or 2 x 4 wood studs, turned flatwise, 24" o.c. with 6d cement-coated nails, 17/8" long, 0.0915" shank, 1/4" heads, 7" o.c. <b>(NLB)</b></p>		<p>Thickness: 27/8"            Approx. Weight: 7 psf            Fire Test: UL, 9-12-96,            UL Design U338</p>	

\*Contact the manufacturer for more detailed information on proprietary products.

**WALLS AND INTERIOR PARTITIONS, WOOD FRAMED**

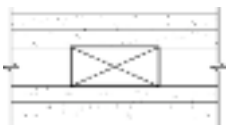
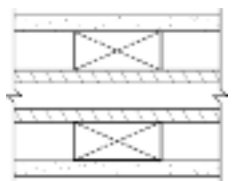
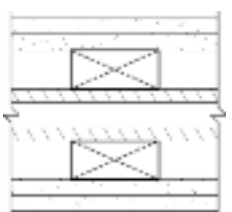
<p><b>GA FILE NO. WP 3641</b></p> <p><b>GYPSUM WALLBOARD, WOOD STUDS</b></p> <p><b>Base</b> layer 5/8" type X gypsum wallboard or gypsum veneer base applied parallel or at right angles to each side of either 2 x 3 or 2 x 4 wood studs, turned flatwise, 24" o.c. with 6d cement-coated nails, 17/8" long, 0.0915" shank, 1/4" heads, 7" o.c. <b>Face</b> layer 5/8" type X gypsum wallboard or gypsum veneer base applied parallel or at right angles to each side with 8d cement-coated nails, 23/8" long, 0.113" shank, 9/32" heads, 8" o.c. <b>(LOAD-BEARING)</b></p>	<p><b>GENERIC</b></p>	<p><b>1 HOUR FIRE</b></p>  <p>Thickness: 4 1/8"                  Approx. Weight: 12 psf                  Fire Test: UL, 9-12-96, UL Design U338</p>
<p><b>GA FILE NO. WP 3642</b></p> <p><b>GYPSUM WALLBOARD, WOOD STUDS</b></p> <p>One layer 5/8" type X gypsum wallboard or gypsum veneer base applied parallel or at right angles to ONE SIDE of either 2 x 3 or 2 x 4 wood studs, turned flatwise, 24" o.c. with 6d cement-coated nails, 17/8" long, 0.0915" shank, 1/4" heads, 7" o.c.</p> <p><b>Inner</b> layer plywood applied with nails.</p> <p>Second wall duplicate of first wall and separated by 1" air space. <b>(NLB)</b></p>	<p><b>GENERIC</b></p>	<p><b>1 HOUR FIRE</b></p>  <p>Thickness: 5 1/2"                  Approx. Weight: 10 psf                  Fire Test: UL, 9-12-96, UL Design U339</p>
<p><b>GA FILE NO. WP 3643</b></p> <p><b>GYPSUM WALLBOARD, WOOD STUDS</b></p> <p><b>Base</b> layer 5/8" type X gypsum wallboard applied parallel or at right angles to each side of a double row of either 2 x 3 or 2 x 4 wood studs, turned flatwise, 24" o.c. on separate plates 1" apart with 6d cement-coated nails, 17/8" long, 0.0915" shank, 1/4" heads, 7" o.c. <b>Face</b> layer 5/8" type X gypsum wallboard applied parallel or at right angles to each side with 8d cement-coated nails, 23/8" long, 0.113" shank, 9/32" heads, 8" o.c. <b>(LOAD-BEARING)</b></p>	<p><b>GENERIC</b></p>	<p><b>1 HOUR FIRE</b></p>  <p>Thickness: 6 3/4"                  Approx. Weight: 13 psf                  Fire Test: UL, 9-12-96, UL Design U339</p>

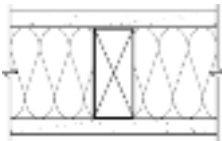
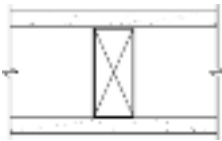
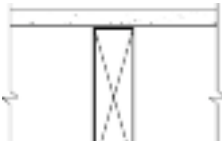
<b>WALLS AND INTERIOR PARTITIONS, WOOD FRAMED</b>			
<b>GA FILE NO. WP 3644</b>	<b>GENERIC</b>	<b>1 HOUR FIRE</b>	
<b>GYPSUM WALLBOARD, WOOD STUDS, MINERAL FIBER INSULATION</b>			
<p>One layer 5/8" type X gypsum wallboard applied at right angles to each side of 2 x 4 wood studs 16" o.c. with 2 1/4" Type S or W drywall screws 12" o.c. 3 1/2" mineral fiber insulation, nominal 2.5 pcf, friction fit in stud space.</p> <p>Vertical joints staggered 16" o.c., horizontal joints staggered 24" o.c., on opposite sides.</p> <p>Tested at 2,578 lbs per stud or 100 percent of design load. <b>(LOAD-BEARING)</b></p>			<p>Thickness: 4 3/4"</p> <p>Approx. Weight: 7.5 psf</p> <p>Fire Test: ITS J20-06170.1, 4-00</p>
<b>GA FILE NO. WP 3645</b>	<b>PROPRIETARY*</b>	<b>1 HOUR FIRE</b>	
<b>GYPSUM PANEL PRODUCTS, WOOD STUDS</b>			
<p>One layer 5/8" thick proprietary type X gypsum board applied parallel or at right angles to ONE SIDE of 2 x 4 wood studs 16" o.c. with 6d coated nails, 1 7/8" long, 0.0915" shank, 1/4" heads 7" o.c.</p> <p>OPPOSITE SIDE: One layer 5/8" proprietary type X glass mat gypsum substrate applied parallel or at right angles to studs with 6d coated nails, 1 7/8" long, 0.0915" shank, 1/4" heads, 7" o.c.</p> <p>Joints staggered 16" on opposite sides. <b>(LOAD-BEARING)</b></p>			<p>Thickness: 4 3/4"</p> <p>Approx. Weight: 7 psf</p> <p>Fire Test: UL R6937, 06NK17692, 9-19-08, UL Design U305</p>
<b>PROPRIETARY GYPSUM PANEL PRODUCTS</b>			
Temple-Inland	-	5/8" GreenGlass Type X	
	-	5/8" Type X	
<b>GA FILE NO. WP 3660</b>	<b>GENERIC</b>	<b>1 HOUR FIRE</b>	
<b>GYPSUM WALLBOARD, WOOD STUDS</b>			
<p>One layer 5/8" type X gypsum wallboard applied at right angles to each side of 2 x 6 wood studs 16" o.c. with 2 1/4" Type S or W drywall screws 7" o.c.</p> <p>Vertical joints staggered 16" o.c., horizontal joints staggered 24" o.c., on opposite sides.</p> <p>Tested at 5,156 lbs per stud or 100 percent of design load. <b>(LOAD-BEARING)</b></p>			<p>Thickness: 6 3/4"</p> <p>Approx. Weight: 8 psf</p> <p>Fire Test: ITS J99-22441.2, 10-99</p>

*\*Contact the manufacturer for more detailed information on proprietary products.*

**WALLS AND INTERIOR PARTITIONS, WOOD FRAMED**

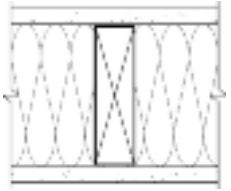
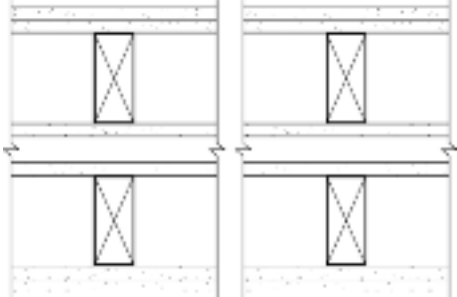
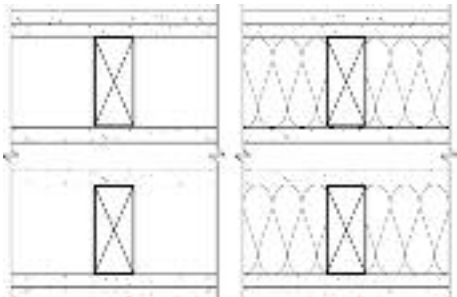
<p><b>GA FILE NO. WP 3661</b></p> <p><b>GENERIC</b></p> <p><b>GYPSUM WALLBOARD, WOOD STUDS, MINERAL FIBER INSULATION</b></p> <p>One layer 5/8" type X gypsum wallboard applied at right angles to each side of 2 x 6 wood studs 16" o.c. with 2 1/4" Type S or W drywall screws 12" o.c. 5 1/2" mineral fiber insulation, nominal 2.5 pcf, friction fit in stud space.</p> <p>Vertical joints staggered 16" o.c., horizontal joints staggered 24" o.c., on opposite sides.</p> <p>Tested at 5,156 lbs per stud or 100 percent of design load. <b>(LOAD-BEARING)</b></p>	<p><b>1 HOUR FIRE</b></p>  <p>Thickness: 6 3/4"                  Approx. Weight: 8.5 psf                  Fire Test: ITS J99-22441.1, 10-99</p>
<p><b>GA FILE NO. WP 3810</b></p> <p><b>GENERIC</b></p> <p><b>GYPSUM WALLBOARD, WOOD STUDS</b></p> <p><b>Base</b> layer 1/2" type X gypsum wallboard or gypsum veneer base applied at right angles to 2 x 4 wood studs 24" o.c. with 6d coated nails, 1 7/8" long, 0.0915" shank, 1/4" heads, 16" o.c. <b>Face</b> layer 1/2" type X gypsum wallboard or gypsum veneer base applied at right angles with 8d coated nails, 2 3/8" long, 0.099" shank, 9/32" heads, 8" o.c. Joints offset 24" from base layer joints.</p> <p><b>Inner</b> layer 1/2" type X gypsum wallboard or gypsum veneer base applied parallel to studs with 6d coated nails, 1 7/8" long, 0.0915" shank, 1/4" heads, 8" o.c. Joints in inner layer need not be taped.</p> <p>Second wall duplicate of first wall and separated by 1" space. Walls independently loaded.</p> <p>STC 59 with 3 1/2" glass fiber insulation friction fit in stud spaces both sides; STC 57 without glass fiber insulation. <b>(LOAD-BEARING)</b></p>	<p><b>2 HOUR FIRE</b></p> <p><b>55 to 59 STC SOUND</b></p>  <p>Thickness: 11"                  Approx. Weight: 14 psf                  Fire Test: FM WP 297, 1-5-73                  Sound Test: RAL TL73-215, 7-13-73; RAL TL73-224, 7-30-73</p>
<p><b>GA FILE NO. WP 3812</b></p> <p><b>GENERIC</b></p> <p><b>GYPSUM WALLBOARD, WOOD STUDS</b></p> <p><b>Base</b> layer 1/2" type X gypsum wallboard or gypsum veneer base applied at right angles to 2 x 4 wood studs 24" o.c. with 6d coated nails, 1 7/8" long, 0.086" shank, 1/4" heads, 16" o.c. <b>Face</b> layer 1/2" type X gypsum wallboard or gypsum veneer base applied at right angles to studs over base layer and to top and bottom plates with 8d coated nails, 2 3/8" long, 0.099" shank, 9/32" heads, 8" o.c. Joints offset 24" from base layer joints.</p> <p><b>Inner</b> layer 5/8" type X gypsum wallboard or gypsum veneer base applied parallel with 6d coated nails, 1 7/8" long, 0.0915" shank, 1/4" heads, 8" o.c. Joints in inner layer need not be taped.</p> <p>Second wall duplicate of first wall and separated by 1" space. Walls independently loaded. Sound tested with 3 1/2" glass fiber insulation, 0.75 pcf, friction fit in stud spaces. <b>(LOAD-BEARING)</b></p>	<p><b>2 HOUR FIRE</b></p> <p><b>55 to 59 STC SOUND</b></p>  <p>Thickness: 11 1/4"                  Approx. Weight: 15 psf                  Fire Test: See WP 3810 (FM WP 297, 1-5-73)                  Sound Test: Estimated Based on WP 3810 (RAL TL73-215, 7-13-73; RAL TL73-224, 7-30-73)</p>

**WALLS AND INTERIOR PARTITIONS, WOOD FRAMED**

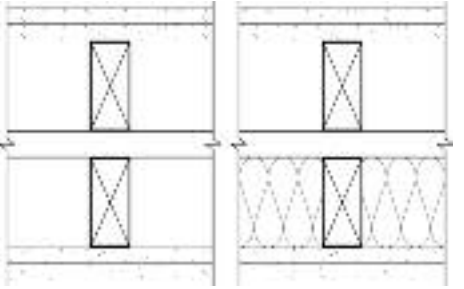
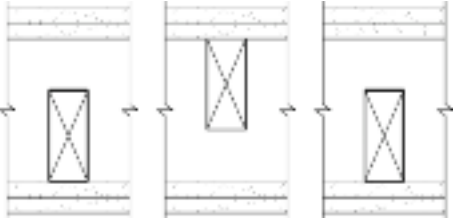
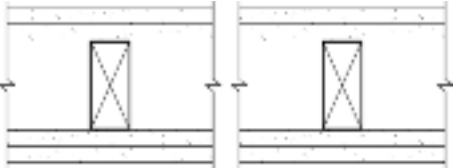
GA FILE NO. WP 3820	GENERIC	2 HOUR FIRE	55 to 59 STC SOUND
<p align="center"><b>GYPSUM WALLBOARD, WOOD STUDS</b></p> <p><b>Base</b> layer 5/8" type X gypsum wallboard or gypsum veneer base applied at right angles to each side of double row of 2 x 4 wood studs 16" o.c. on separate plates 1" apart with 6d coated nails, 17/8" long, 0.085" shank, 1/4" heads, 24" o.c. <b>Face</b> layer 5/8" type X gypsum wallboard or gypsum veneer base applied at right angles to each side with 8d coated nails, 23/8" long, 0.100" shank, 1/4" heads, 8" o.c.</p> <p>Joints staggered 16" each layer and side. Sound tested with 3 1/2" glass fiber insulation stapled to studs in stud spaces on one side and with nails for base layer spaced 6" o.c. Horizontal bracing required at mid-height. <b>(LOAD-BEARING)</b></p>			
		<p>Thickness: 10 3/4"            Approx. Weight: 13 psf            Fire Test: See WP 4135            (FM WP 360, 9-27-74);            UL R4024, 10-31-68            Sound Test: NGC 3056, 4-7-70</p>	
GA FILE NO. WP 3910	GENERIC	2 HOUR FIRE	50 to 54 STC SOUND
<p align="center"><b>GYPSUM WALLBOARD, WOOD STUDS</b></p> <p><b>Base</b> layer 5/8" type X gypsum wallboard or gypsum veneer base applied at right angles to each side of 2 x 4 wood studs 16" o.c., staggered 8" o.c. on 2 x 6 wood plates, with 6d coated nails, 17/8" long, 0.085" shank, 1/4" heads, 24" o.c. <b>Face</b> layer 5/8" type X gypsum wallboard or gypsum veneer base applied at right angles to each side with 8d coated nails, 23/8" long, 0.113" shank, 9/32" heads, 8" o.c.</p> <p>Joints staggered 16" each layer and side. Sound tested with nails for base layer spaced 6" o.c. Horizontal bracing required at mid-height. <b>(LOAD-BEARING)</b></p>			
		<p>Thickness: 8"            Approx. Weight: 13 psf            Fire Test: See WP 4135            (FM WP 360, 9-27-74);            UL R4024, 10-31-68            Sound Test: NGC 2377, 5-19-70</p>	
GA FILE NO. WP 4135	GENERIC	2 HOUR FIRE	40 to 44 STC SOUND
<p align="center"><b>GYPSUM WALLBOARD, WOOD STUDS</b></p> <p><b>Base</b> layer 5/8" type X gypsum wallboard or gypsum veneer base applied at right angles to each side of 2 x 4 wood studs 24" o.c. with 6d coated nails, 17/8" long, 0.085" shank, 1/4" heads, 24" o.c. <b>Face</b> layer 5/8" type X gypsum wallboard or gypsum veneer base applied at right angles to each side with 8d coated nails, 23/8" long, 0.100" shank, 1/4" heads, 8" o.c.</p> <p>Joints staggered 24" each layer and side. Sound tested with studs 16" o.c. and with nails for base layer spaced 6" o.c. <b>(LOAD-BEARING)</b></p>			
		<p>Thickness: 6 1/8"            Approx. Weight: 12 psf            Fire Test: FM WP 360, 9-27-74            Sound Test: NGC 2363, 4-1-70</p>	

**WALLS AND INTERIOR PARTITIONS, WOOD FRAMED**

<b>GA FILE NO. WP 4136</b>	<b>GENERIC</b>	<b>2 HOUR FIRE</b>	<b>40 to 44 STC SOUND</b>
<b>GYPSUM WALLBOARD, WOOD STUDS</b>			
<p><b>Base</b> layer 5/8" type X gypsum wallboard or veneer base applied parallel or at right angles to each side of 2 x 4 wood studs 16" o.c. with 1 1/4" Type W drywall screws 12" o.c. <b>Face</b> layer 5/8" type X gypsum wallboard or veneer base applied parallel or at right angles to each side with 1 7/8" Type W drywall screws 12" o.c. and offset 6" from screws in base layer.</p>			
<p>Joints staggered 16" each layer and side. <b>(LOAD-BEARING)</b></p>		<p>Thickness: 6 1/8"                  Approx. Weight: 12 psf                  Fire Test: SWRI 01-5920-614, 12-5-94                  Sound Test: See WP 4135 (NGC 2363, 4-1-70)</p>	

<b>GA FILE NO. WP 4230</b>	<b>GENERIC</b>	<b>2 HOUR FIRE</b>	
<b>GYPSUM WALLBOARD, WOOD STUDS, MINERAL FIBER INSULATION</b>			
<p><b>Base</b> layer 5/8" type X gypsum wallboard applied at right angles to each side of 2 x 6 wood studs 24" o.c. with 2 1/4" Type S or W drywall screws 24" o.c. <b>Face</b> layer 5/8" type X gypsum wallboard applied at right angles to each side with 2 1/4" Type S drywall screws 8" o.c. 5 1/2" mineral fiber insulation, nominal 3 pcf, friction fit in stud space.</p>			
<p>Joints staggered 24" each layer and side.</p>			
<p>Tested at 5,506 lbs per stud or 100 percent of design load. <b>(LOAD-BEARING)</b></p>		<p>Thickness: 8"                  Approx. Weight: 13 psf                  Fire Test: ITS J20-06170.3, 12-00</p>	

**This Space Left Blank**



CHASE WALLS, NONCOMBUSTIBLE															
GA FILE NO. WP 5005	PROPRIETARY*	1 HOUR FIRE	60 to 64 FSTC SOUND												
<p align="center"><b>GYPSUM WALLBOARD, STEEL STUDS, MINERAL FIBER INSULATION, CEMENTITIOUS BACKER UNIT CERAMIC TILE</b></p> <p>One layer 5/8" proprietary type X gypsum wallboard or gypsum veneer base applied parallel to ONE SIDE of a double row of 15/8" 20 gage steel studs 16" o.c. with 1" Type S-12 drywall screws 8" o.c. at edges and 12" o.c. at intermediate studs. 5/8" gypsum board pieces 6" wide located not more than 48" o.c. used as cross braces fastened to stud pairs with two 1" Type S drywall screws at each end of brace. Optionally, 25 gage stud or runner pieces may be used as cross braces and attached with two 1/2" Type S drywall screws at each end. 1 1/2" mineral fiber insulation, 2 pcf, on each side in stud space.</p> <p>OPPOSITE SIDE: One layer 1/2" proprietary cementitious backer unit applied at right angles to studs with 1 1/4" Type S-12 wafer head screws 8" o.c. Vertical joints staggered and covered with glass fiber mesh tape. Ceramic tile, 1/4" thick, joints grouted, installed with latex-modified portland cement mortar or ANSI A136.1 Type I organic adhesive. <b>(NLB)</b></p> <p align="center"><b>PROPRIETARY GYPSUM BOARD</b></p> <table border="0"> <tr> <td>American Gypsum Company LLC</td> <td>-</td> <td>5/8" FireBloc® Type X</td> </tr> <tr> <td>Lafarge North America Inc.</td> <td>-</td> <td>5/8" Firecheck® Type X</td> </tr> <tr> <td>Temple-Inland</td> <td>-</td> <td>5/8" Type X</td> </tr> <tr> <td>United States Gypsum Company</td> <td>-</td> <td>5/8" SHEETROCK® Brand FIRECODE® Core Gypsum Panels</td> </tr> </table>		American Gypsum Company LLC	-	5/8" FireBloc® Type X	Lafarge North America Inc.	-	5/8" Firecheck® Type X	Temple-Inland	-	5/8" Type X	United States Gypsum Company	-	5/8" SHEETROCK® Brand FIRECODE® Core Gypsum Panels		
American Gypsum Company LLC	-	5/8" FireBloc® Type X													
Lafarge North America Inc.	-	5/8" Firecheck® Type X													
Temple-Inland	-	5/8" Type X													
United States Gypsum Company	-	5/8" SHEETROCK® Brand FIRECODE® Core Gypsum Panels													
<p align="center"><b>GYPSUM WALLBOARD, STEEL STUDS, GLASS FIBER INSULATION</b></p> <p>One layer 5/8" proprietary type X gypsum wallboard or gypsum veneer base applied parallel or at right angles to ONE SIDE of a double row of 2 1/2" 20 gage steel studs 16" o.c. and not less than 1" apart with 1" Type S drywall screws 8" o.c. when applied at right angles to studs and 8" at vertical and bottom edges and 12" o.c. at intermediate studs when applied parallel to studs.</p> <p>OPPOSITE SIDE: One layer 5/8" proprietary type X gypsum wallboard or gypsum veneer base applied parallel or at right angles to studs with 1" Type S drywall screws 8" o.c. when applied at right angles to studs and 8" at vertical and bottom edges and 12" o.c. at intermediate studs when applied parallel to studs.</p> <p>Vertical joints centered over studs and staggered one stud cavity on opposite sides of studs. Horizontal joints need not be backed by framing. Horizontal joints on opposite sides need not be staggered. Lateral bracing on both sides of the wall not less than 5 feet on center vertically.</p> <p>Sound tested with a second layer of 5/8" proprietary type X gypsum wallboard on one side and a double row of 3 5/8" steel studs with 3 1/2" glass fiber insulation, 0.5 pcf, on both sides in cavity. <b>(NLB)</b></p> <p align="center"><b>PROPRIETARY GYPSUM BOARD</b></p> <table border="0"> <tr> <td>United States Gypsum Company</td> <td>-</td> <td>5/8" SHEETROCK® Brand FIRECODE® Core Gypsum Panels</td> </tr> </table>		United States Gypsum Company	-	5/8" SHEETROCK® Brand FIRECODE® Core Gypsum Panels	1 HOUR FIRE	60 to 64 STC SOUND									
United States Gypsum Company	-	5/8" SHEETROCK® Brand FIRECODE® Core Gypsum Panels													
<p align="center"><b>GYPSUM WALLBOARD, STEEL STUDS</b></p> <p>One layer 5/8" type X gypsum wallboard or gypsum veneer base applied parallel to a double row of 1 5/8" steel studs 24" o.c. and not less than 1" apart with 1" Type S drywall screws 8" o.c. at edges and 12" o.c. at intermediate studs. 5/8" gypsum board pieces 12" long x not less than 4 1/2" wide located at 1/3 points used as cross braces fastened to stud pairs with three 1" Type S drywall screws at each end of brace. Optionally 25 gage stud or runner pieces, not less than 4 1/2" long, may be used as cross braces and attached with two No. 8 x 1 1/2" self-drilling steel screws at each end. Where total cavity depth exceeds 9 1/2", cross braces shall be fabricated from 25 gage stud or runner pieces.</p> <p>Joints staggered 24" on opposite sides. Sound tested with 3 1/2" glass fiber insulation stapled to one side in cavity. <b>(NLB)</b></p>		1 HOUR FIRE	50 to 54 STC SOUND												
<p>Thickness: 4 1/4" Approx. Weight: 5 1/2 psf Fire Test: UL R4024-13, -14, 11-17-76; UL R3660, 04NK28128, 11-18-04; UL Design U420 Sound Test: RAL TL76-155, 6-3-76</p>															

\*Contact the manufacturer for more detailed information on proprietary products.

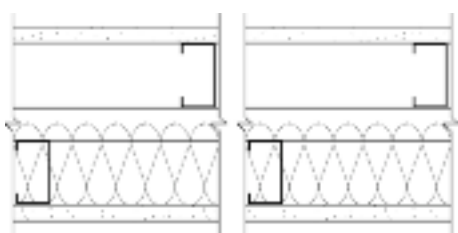
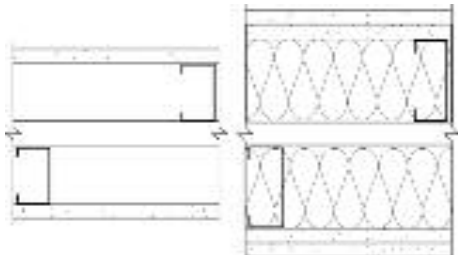
<b>CHASE WALLS, NONCOMBUSTIBLE</b>				
<b>GA FILE NO. WP 5017</b>	<b>PROPRIETARY*</b>	<b>1 HOUR FIRE</b>	<b>50 to 54 STC SOUND</b>	
<p style="text-align: center;"><b>GYPSUM WALLBOARD, STEEL STUDS, GLASS FIBER INSULATION</b></p> <p>One layer 5/8" proprietary type X gypsum wallboard or gypsum veneer base applied parallel or at right angles to ONE SIDE of a double row of 2 1/2" 25 gage steel studs 24" o.c. and not less than 1" apart with 1" Type S drywall screws 8" o.c.</p> <p>OPPOSITE SIDE: One layer 5/8" proprietary type X gypsum wallboard or gypsum veneer base applied parallel or at right angles to studs with 1" Type S drywall screws 8" o.c. Optional insulation in the cavity.</p> <p>Vertical joints centered over studs and staggered one stud cavity on opposite sides of studs. Horizontal joints on opposite sides need not be staggered or backed. Lateral bracing on both sides of the wall not less than 5 feet on center vertically.</p> <p>Sound tested with 3 1/2" glass fiber insulation friction fit on one side in cavity. <b>(NLB)</b></p> <p style="text-align: center;"><b>PROPRIETARY GYPSUM BOARD</b></p> <p>CertainTeed Gypsum Inc. - 5/8" ProRoc® Type X Gypsum Panels</p>				<p>Thickness: Minimum 7 1/4"</p> <p>Approx. Weight: 7 psf</p> <p>Fire Test: UL R3660, 06NK13008, 7-7-06; 07SR3014402, 12-18-07; 08CA14331, 6-18-08;</p> <p>Sound Test: UL Design V469 RAL TL06-299, 8-10-06</p>
<b>GA FILE NO. WP 5060</b>	<b>PROPRIETARY*</b>	<b>2 HOUR FIRE</b>	<b>65 to 69 STC SOUND</b>	
<p style="text-align: center;"><b>GYPSUM WALLBOARD, STEEL STUDS, GLASS FIBER INSULATION</b></p> <p><b>Base</b> layer 5/8" proprietary type X gypsum wallboard or gypsum veneer base applied parallel or at right angles to ONE SIDE of a double row of 3 5/8" 18 gage steel studs 16" o.c. and not less than 1" apart with 1" Type S drywall screws 16" o.c. <b>Face</b> layer 5/8" proprietary type X gypsum wallboard or gypsum veneer base applied parallel or at right angles to same side of studs with 1 5/8" Type S drywall screws 12" o.c. Face layer vertical joints offset one stud cavity from base layer vertical joints. Face layer horizontal joints offset not less than 6" from base layer horizontal joints.</p> <p>OPPOSITE SIDE: <b>Base</b> layer 5/8" proprietary type X gypsum wallboard or gypsum veneer base applied parallel or at right angles to studs with 1" Type S drywall screws 16" o.c. <b>Face</b> layer 5/8" proprietary type X gypsum wallboard or gypsum veneer base applied parallel or at right angles to same side of studs with 1 5/8" Type S drywall screws 12" o.c. Face layer vertical joints offset one stud cavity from base layer vertical joints. Face layer horizontal joints offset not less than 6" from base layer horizontal joints.</p> <p>Vertical joints centered over studs and staggered one stud cavity on opposite sides of studs. Horizontal joints need not be backed by framing. Horizontal joints on opposite sides need not be staggered. Lateral bracing on both sides of the wall not less than 5 feet on center vertically.</p> <p>Sound tested using a double row of 3 5/8" steel studs and 3 1/2" glass fiber insulation, 0.5 pcf, on both sides in cavity. <b>(NLB)</b></p> <p style="text-align: center;"><b>PROPRIETARY GYPSUM BOARD</b></p> <p>United States Gypsum Company - 5/8" SHEETROCK® Brand FIRECODE® Core Gypsum Panels</p>				<p>Thickness: Minimum 8 1/2" (Fire) Minimum 10 3/4" (Sound)</p> <p>Approx. Weight: 9 psf</p> <p>Fire Test: UL R1319, 96NK31548, 10-21-96</p> <p>Sound Test: UL Design U493 USG STC-050819, 8-12-05</p>

\*Contact the manufacturer for more detailed information on proprietary products.

**CHASE WALLS, NONCOMBUSTIBLE**

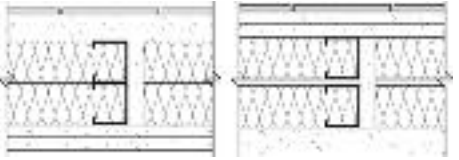

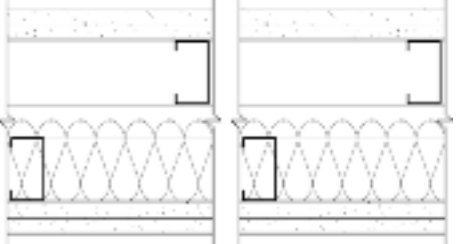
GA FILE NO. WP 5070	PROPRIETARY*	2 HOUR FIRE	60 to 64 FSTC SOUND
<b>GYPSUM WALLBOARD, STEEL STUDS, MINERAL FIBER INSULATION, CEMENTITIOUS BACKER UNIT, CERAMIC TILE</b>			
<p><b>Base</b> layer 1/2" proprietary type X gypsum wallboard or gypsum veneer base applied parallel on each side of a double row of 15/8" 20 gage steel studs spaced 24" o.c. with 1" Type S-12 drywall screws 24" o.c. 1/2" gypsum board pieces 6" wide located not more than 48" o.c. used as cross braces fastened to stud pairs with two 1" Type S drywall screws at each end of brace. Optionally, 25 gage stud or runner pieces may be used as cross braces and attached with two 1/2" Type S drywall screws at each end. 1 1/2" mineral fiber insulation, 2.0 pcf, on each side in stud space. <b>Face</b> layer 1/2" proprietary type X gypsum wallboard or gypsum veneer base applied parallel to ONE SIDE with 15/8" Type S drywall screws 12" o.c. Joints offset 24" from base layer joints.</p> <p>OPPOSITE SIDE: <b>Face</b> layer 1/2" proprietary cementitious backer unit applied at right angles to studs with 15/8" Type S-12 wafer head screws 8" o.c. Vertical joints offset 24" from base layer vertical joints. Joints covered with glass fiber mesh tape. Ceramic tile 1/4" thick, joints grouted, installed with latex-modified portland cement mortar or ANSI A136.1 Type I organic adhesive.</p> <p>Sound tested with 1/4" space between the rows of stud. <b>(NLB)</b></p>		<p>Thickness: 5 1/2" (Fire) 5 3/4" (Sound)</p> <p>Approx. Weight: 14 psf</p> <p>Fire Test: UL R11270, 4-19-85; UL R3660, 02NK35115, 9-15-03; UL Design U444</p> <p>Field Sound Test: SA-851102, 11-6-85</p> <p>Sound Test: NRCC TL-93-308, 12-2-02</p>	
<p><b>PROPRIETARY GYPSUM BOARD</b></p> <p>American Gypsum Company LLC - 1/2" FireBloc® Type C</p> <p>CertainTeed Gypsum Inc. - 1/2" ProRoc® Type C Gypsum Panels</p> <p>Lafarge North America Inc. - 1/2" Firecheck® Type C</p> <p>National Gypsum Company - 1/2" Gold Bond® Brand FIRE-SHIELD C™ Gypsum Board</p> <p>Temple-Inland - 1/2" TC-C</p> <p>United States Gypsum Company - 1/2" SHEETROCK® Brand FIRECODE® C Core Gypsum Panels</p>			

GA FILE NO. WP 5071	PROPRIETARY*	2 HOUR FIRE	60 to 64 STC SOUND
<b>GYPSUM WALLBOARD, STEEL STUDS, GLASS FIBER INSULATION</b>			
<p><b>Base</b> layer 5/8" proprietary type X gypsum wallboard or gypsum veneer base applied parallel or at right angles to ONE SIDE of a double row of 2 1/2" 25 gage steel studs 24" o.c. and not less than 1" apart with 1" Type S drywall screws 16" o.c. <b>Face</b> layer 5/8" proprietary type X gypsum wallboard or gypsum veneer base applied parallel or at right angles to same side of studs with 15/8" Type S drywall screws 8" o.c. when applied parallel and 16" o.c. when applied at right angles. Face layer vertical joints offset one stud cavity from base layer vertical joints. Face layer horizontal joints offset not less than 12" from base layer horizontal joints.</p> <p>OPPOSITE SIDE: <b>Base</b> layer 5/8" proprietary type X gypsum wallboard or gypsum veneer base applied parallel or at right angles to studs with 1" Type S drywall screws 16" o.c. <b>Face</b> layer 5/8" proprietary type X gypsum wallboard or gypsum veneer base applied parallel or at right angles to same side of studs with 15/8" Type S drywall screws 8" o.c. when applied parallel and 16" o.c. when applied at right angles. Face layer vertical joints offset one stud cavity from base layer vertical joints. Face layer horizontal joints offset not less than 12" from base layer horizontal joints. Optional insulation in the cavity.</p> <p>Vertical joints centered over studs and staggered one stud cavity on opposite sides of wall. Horizontal joints on opposite sides need not be staggered or backed. Lateral bracing on both sides of the wall not less than 5 feet on center vertically. <b>(NLB)</b></p> <p>Sound tested with 3/2" glass fiber insulation friction fit on one side in cavity.</p>		<p>Thickness: Minimum 8 1/2"</p> <p>Approx. Weight: 9 psf</p> <p>Fire Test: UL R3660, 06NK13008, 7-7-06; 07SR3014402, 12-18-07; 08CA14331, 6-18-08; UL Design V469</p> <p>Sound Test: RAL TL06-300, 8-11-06</p>	
<p><b>PROPRIETARY GYPSUM BOARD</b></p> <p>CertainTeed Gypsum Inc. - 5/8" ProRoc® Type X Gypsum Panels</p>			

\*Contact the manufacturer for more detailed information on proprietary products.

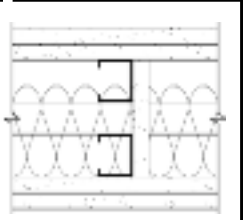
**CHASE WALLS, NONCOMBUSTIBLE**

<b>GA FILE NO. WP 5105</b>	<b>GENERIC</b>	<b>2 HOUR FIRE</b>	<b>55 to 59 STC SOUND</b>
<p align="center"><b>GYPSON WALLBOARD, STEEL STUDS</b></p> <p><b>Base</b> layer 5/8" type X gypsum wallboard or gypsum veneer base applied parallel to a double row of 1 5/8" steel studs 24" o.c. and not less than 1" apart with 1" Type S drywall screws 8" o.c. at edges and 12" o.c. at intermediate studs. 5/8" gypsum board pieces 12" long x not less than 4 1/2" wide located at 1/3 points used as cross braces fastened to stud pairs with three 1" Type S drywall screws at each end of brace. Optionally 25 gage stud or runner pieces, not less than 4 1/2" long, may be used as cross braces and attached with two No. 8 x 1/2" self-drilling steel screws at each end. Where total cavity depth exceeds 9 1/2", cross braces shall be fabricated from 25 gage stud or runner pieces.</p> <p><b>Face</b> layer 5/8" type X gypsum wallboard or gypsum veneer base applied parallel to each side with 1 5/8" Type S drywall screws 8" o.c. at joints and floor and ceiling runners and 12" o.c. at intermediate studs.</p> <p>Joints staggered 24" each layer and side. Sound tested with 3 1/2" glass fiber insulation stapled in stud space. <b>(NLB)</b></p>		 <p>Thickness: 12"          Approx. Weight: 10 psf          Fire Test: UL R4024-13, -14, 11-17-76; UL R3660, 04NK28128, 11-18-04; UL Design U420          Sound Test: RAL TL76-156, 6-7-76</p>	

<b>GA FILE NO. WP 5130</b>	<b>GENERIC</b>	<b>2 HOUR FIRE</b>	<b>50 to 54 STC SOUND</b>
<p align="center"><b>GYPSON WALLBOARD, STEEL STUDS</b></p> <p><b>Base</b> layer 5/8" type X gypsum wallboard or gypsum veneer base applied parallel to a double row of 1 5/8" steel studs 24" o.c. and not less than 1" apart with 1" Type S drywall screws 8" o.c. at edges and 12" o.c. at intermediate studs. 5/8" gypsum board pieces 12" long x not less than 4 1/2" wide located at 1/3 points used as cross braces fastened to stud pairs with three 1" Type S drywall screws at each end of brace. Optionally 25 gage stud or runner pieces, not less than 4 1/2" long, may be used as cross braces and attached with two No. 8 x 1/2" self-drilling steel screws at each end. Where total cavity depth exceeds 9 1/2", cross braces shall be fabricated from 25 gage stud or runner pieces.</p> <p><b>Face</b> layers 5/8" type X gypsum wallboard or gypsum veneer base applied parallel to each side with 1 5/8" Type S drywall screws 8" o.c. at joints and floor and ceiling runners and 12" o.c. at intermediate studs.</p> <p>Joints staggered each layer and side. <b>(NLB)</b></p>		 <p>Thickness: 12"          Approx. Weight: 10 psf          Fire Test: UL R4024-13, -14, 11-17-76; UL R3660, 04NK28128, 11-18-04; UL Design U420          Sound Test: RAL TL76-162, 6-11-76</p>	

**This Space Left Blank**

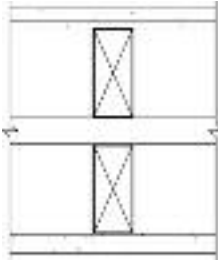
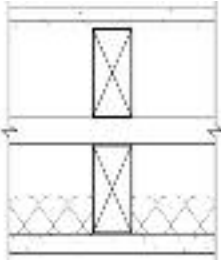
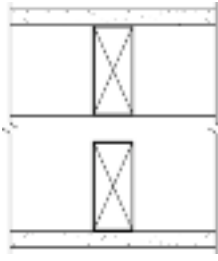
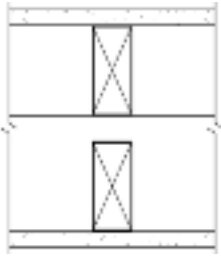
CHASE WALLS, WOOD FRAMED				
GA FILE NO. WP 5510	GENERIC	1 HOUR FIRE	55 to 59 STC SOUND	
<p align="center"><b>GYPSUM WALLBOARD, WOOD STUDS</b></p> <p><b>Base</b> layer 1/4" gypsum wallboard applied parallel to each side of double row of 2 x 4 wood studs 16" o.c. on separate plates spaced 1 1/2" apart with 4d coated nails, 1 1/2" long, 0.099" shank, 1/4" heads, 12" o.c. Joints staggered 16" on opposite sides. <b>Face</b> layer 1/2" type X plain or predecorated gypsum wallboard or gypsum veneer base applied parallel to each side with 3/8" beads of adhesive 16" o.c. and 5d coated nails, 1 3/4" long, 0.099" shank, 1/4" heads, 16" o.c. at top and bottom plates. 4d finish nails, 1 1/2" long, 0.072" shank, 0.1055" heads, driven at a 45° angle 16" o.c. horizontally and 24" o.c. vertically. Joints offset 24" from base layer joints.</p> <p>Sound tested with 1 1/2" mineral fiber insulation in stud space. Horizontal bracing required at mid-height. <b>(LOAD-BEARING)</b></p>				<p>Thickness: 10"</p> <p>Approx. Weight: 9 psf</p> <p>Fire Test: See WP 3341 (FM WP-147, 1-2-69); UL R4024, 10-31-68</p> <p>Sound Test: G&amp;H BW-32ST, 4-22-68</p>
GA FILE NO. WP 5512	GENERIC	1 HOUR FIRE	45 to 49 STC SOUND	
<p align="center"><b>GYPSUM WALLBOARD, WOOD STUDS</b></p> <p>One layer 5/8" type X gypsum wallboard or gypsum veneer base applied parallel or at right angles to each side of double row of 2 x 4 wood studs 16" o.c. on separate plates 1" apart with 6d coated nails, 1 7/8" long, 0.0915" shank, 1/4" heads, 7" o.c.</p> <p>Joints staggered 16" on opposite sides. Horizontal bracing required at mid-height. <b>(LOAD-BEARING)</b></p>				<p>Thickness: 9 1/4"</p> <p>Approx. Weight: 8 psf</p> <p>Fire Test: See WP 3605 (UL R1319-4, -6, 6-17-52; UL R2717-39, 1-20-66; UL R3501-52, 3-15-66, UL Design U305; ULC Design W301); UL R4024, 10-31-68</p> <p>Sound Test: NRCC TL-93-261, IRC-IR-761, 3/98</p>

**CHASE WALLS, WOOD FRAMED**

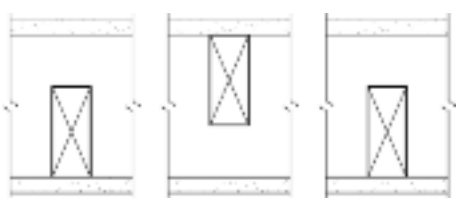
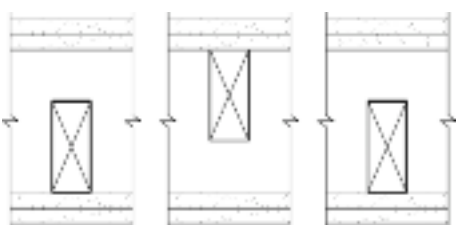
GA FILE NO. WP 5515	GENERIC	1 HOUR FIRE	40 to 44 STC SOUND
<p align="center"><b>GYPSUM WALLBOARD, WOOD STUDS</b></p> <p>One layer 5/8" type X gypsum wallboard or gypsum veneer base applied parallel or at right angles to each side of 2 x 4 wood studs 16" o.c. staggered 8" o.c. on 2 x 6 wood plates with 6d coated nails, 17/8" long, 0.0915" shank, 1/4" heads, 7" o.c.</p> <p>Joints staggered 24" on opposite sides. Horizontal bracing required at mid-height. <b>(LOAD-BEARING)</b></p>			
<p align="center"><b>GYPSUM WALLBOARD, WOOD STUDS</b></p> <p><b>Base</b> layer 5/8" type X gypsum wallboard or gypsum veneer base applied at right angles to each side of double row of 2 x 4 wood studs 16" o.c. on separate plates 1" apart with 6d coated nails, 17/8" long, 0.085" shank, 1/4" heads, 24" o.c. <b>Face</b> layer 5/8" type X gypsum wallboard or gypsum veneer base applied at right angles to each side with 8d coated nails, 23/8" long, 0.100" shank, 1/4" heads, 8" o.c.</p> <p>Joints staggered 16" each layer and side. Sound tested with 3 1/2" glass fiber insulation stapled to studs in stud spaces on one side and with nails for base layer spaced 6" o.c. Horizontal bracing required at mid-height. <b>(LOAD-BEARING)</b></p>		<p align="center"><b>2 HOUR FIRE</b></p> <p align="center"><b>55 to 59 STC SOUND</b></p>	
<p align="center"><b>GYPSUM WALLBOARD, WOOD STUDS</b></p> <p><b>Base</b> layer 5/8" type X gypsum wallboard or gypsum veneer base applied at right angles to each side of 2 x 4 wood studs 16" o.c. staggered 8" o.c. on 2 x 6 wood plates with 6d coated nails, 17/8" long, 0.085" shank, 1/4" heads, 24" o.c. <b>Face</b> layer 5/8" type X gypsum wallboard or gypsum veneer base applied at right angles to each side with 8d coated nails, 23/8" long, 0.113" shank, 9/32" heads, 8" o.c.</p> <p>Joints staggered 16" each layer and side. Sound tested with nails for base layer spaced 6" o.c. Horizontal bracing required at mid-height. <b>(LOAD-BEARING)</b></p>		<p align="center"><b>2 HOUR FIRE</b></p> <p align="center"><b>50 to 54 STC SOUND</b></p>	
<p>Thickness: 7 3/4" Approx. Weight: 8 psf Fire Test: See WP 3605 (UL R1319-4, -6, 6-17-52; UL R2717-39, 1-20-66; UL R3501-52, 3-15-66, UL Design U305; ULC Design W301); UL R4024, 10-31-68 Sound Test: NRCC TL-93-254, IRC-IR-761, 3/98</p>		<p>Thickness: 10 3/4" Approx. Weight: 13 psf Fire Test: See WP 4135 (FM WP-360, 9-27-74); UL R4024, 10-31-68 Sound Test: NGC 3056, 4-7-70</p>	
<p>Thickness: 8" Approx. Weight: 13 psf Fire Test: See WP 4135 (FM WP-360, 9-27-74); UL R4024, 10-31-68 Sound Test: NGC 2377, 5-19-70</p>			

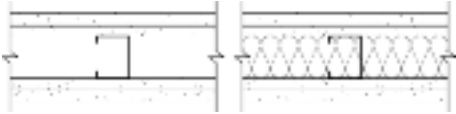
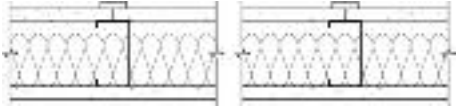
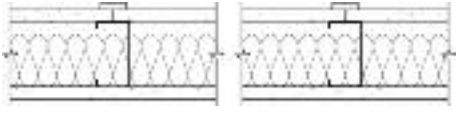
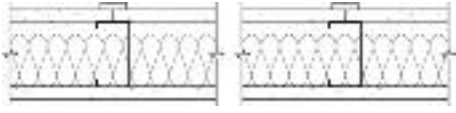
MOVABLE AND OFFICE PARTITIONS				
<b>GA FILE NO. WP 5910</b>	<b>PROPRIETARY*</b>	<b>1 HOUR FIRE</b>	<b>50 to 54 STC SOUND</b>	
<b>GYPSUM WALLBOARD, STEEL STUDS</b>				
<p>Base layer 3/8" gypsum wallboard applied parallel to each side of 15/8" steel studs 24" o.c. with 1" Type S drywall screws 12" o.c. at edges and ends only. Face layer 1/2" proprietary type X predecorated gypsum wallboard applied parallel to each side with proprietary clips 17" o.c. at edges and 15/8" Type S drywall screws 12" o.c. at floor and ceiling runners. Clips attached to studs with 1" Type S drywall screws.</p> <p>Joints staggered 24" o.c. each layer and side. Sound tested with 23/4" glass fiber insulation in stud space. (NLB)</p>		<p>Thickness: 33/8"            Approx. Weight: 7 psf            Fire Test: ULC 78T70, 7-25-78,            ULC Design W410            Sound Test: BGL 471, 5-16-79</p>		
<p><b>PROPRIETARY GYPSUM BOARD</b>            CertainTeed Gypsum Canada Inc. - 1/2" ProRoc® Type C Gypsum Panels</p>				
<b>GA FILE NO. WP 6010</b>	<b>GENERIC</b>	<b>1 HOUR FIRE</b>	<b>45 to 49 STC SOUND</b>	
<b>GYPSUM WALLBOARD, MINERAL FIBER INSULATION, STEEL STUDS</b>				
<p>One layer 1/2" type X predecorated gypsum wallboard applied parallel to each side of 21/2" steel studs 24" o.c. with 1" Type S drywall screws 30" o.c. at vertical joints. Aluminum battens snapped over 7/8" wide, 25 gage galvanized steel track at vertical joints attached with 1" Type S drywall screws 12" o.c. 21/2" aluminum base applied along bottom edge on steel base clips 24" o.c. applied with 11/4" Type S drywall screws. 2" mineral fiber insulation, 3.0 pcf, in stud space.</p> <p>Joints staggered 24" on opposite sides. (NLB)</p>		<p>Thickness: 31/2"            Approx. Weight: 5 psf            Fire Test: FM WP 96-1, 6-23-67            Sound Test: NGC 2213, 8-3-67</p>		
<b>GA FILE NO. WP 6020</b>	<b>GENERIC</b>	<b>1 HOUR FIRE</b>	<b>45 to 49 STC SOUND</b>	
<b>GYPSUM WALLBOARD, MINERAL FIBER INSULATION, STEEL STUDS</b>				
<p>One layer 1/2" type X predecorated gypsum wallboard applied parallel to each side of 21/2" steel studs 24" o.c. with 1" Type S drywall screws 30" o.c. at vertical joints and adhesive at intermediate studs. Aluminum battens snapped over 7/8" wide, 25 gage galvanized steel track at vertical joints attached with 1" Type S drywall screws 9" o.c. 21/2" aluminum base applied along bottom edge on steel base clips 24" o.c. applied with 11/4" Type S drywall screws. 2" mineral fiber insulation, 3.7 pcf, in stud space.</p> <p>Joints staggered 24" on opposite sides. (NLB)</p>		<p>Thickness: 31/2"            Approx. Weight: 5 psf            Fire Test: FM WP 110-1, 10-5-67            Sound Test: RAL TL65-101, 4-1-65</p>		
<b>GA FILE NO. WP 6025</b>	<b>GENERIC</b>	<b>1 HOUR FIRE</b>	<b>45 to 49 FSTC SOUND</b>	
<b>GYPSUM WALLBOARD, MINERAL FIBER INSULATION, STEEL STUDS</b>				
<p>One layer 1/2" type X gypsum wallboard applied parallel to each side of 21/2" steel studs 24" o.c. with 1" Type S drywall screws 12" o.c. at vertical joints and 1/2" beads of adhesive at intermediate studs. Aluminum battens applied over joints with 1" Type S drywall screws 12" o.c. 2" mineral fiber insulation, 3.8 pcf, in stud space. 31/2" aluminum base applied along bottom edge on steel base clips 24" o.c. applied with 11/4" Type S drywall screws.</p> <p>Joints staggered 24" on opposite sides. (NLB)</p>		<p>Thickness: 31/2"            Approx. Weight: 5 psf            Fire Test: UC, 7-27-70            Field Sound Test: USG 17084, 8-18-70</p>		

\*Contact the manufacturer for more detailed information on proprietary products.

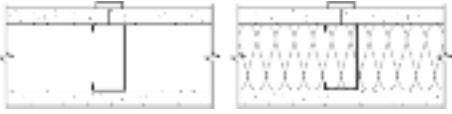
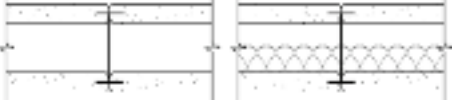
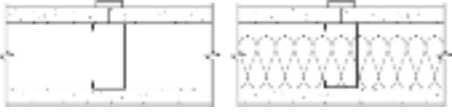
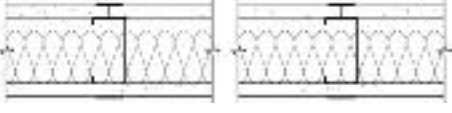
<b>MOVABLE AND OFFICE PARTITIONS</b>			
<b>GA FILE NO. WP 6040</b>	<b>GENERIC</b>	<b>1 HOUR FIRE</b>	<b>45 to 49 STC SOUND</b>
<b>GYPSUM WALLBOARD, STEEL STUDS</b>			
<p>One layer 5/8" type X predecorated gypsum wallboard applied parallel to each side of 2 1/2" steel studs 24" o.c. with 7/8" wide, 25 gage galvanized steel track fastened over each stud with 1 1/8" Type S drywall screws 9" o.c. Aluminum battens snapped over steel track and 2 1/2" aluminum base applied along bottom edge on steel base clips 24" o.c. applied with 1 1/4" Type S drywall screws.</p> <p>Joints staggered 24" o.c. each side. Sound tested with 3" glass fiber insulation in stud space. STC 40 to 44 without glass fiber insulation. <b>(NLB)</b></p>		<p>Thickness: 3 3/4"                      Approx. Weight: 7 psf                      Fire Test: UL R3501-23, -24; 6-4-63;                      UL Design U405                      Sound Test: G&amp;H NG-145FT, 4-17-64;                      NG-146FT, 4-20-64</p>	
<b>GA FILE NO. WP 6070</b>	<b>PROPRIETARY*</b>	<b>1 HOUR FIRE</b>	<b>45 to 49 FSTC SOUND</b>
<b>GYPSUM WALLBOARD, STEEL STUDS</b>			
<p>One layer 24" or 30" wide 3/4" kerfed, beveled-edge proprietary gypsum wallboard applied parallel to each side of 2 5/8" H-studs 24" or 30" o.c. and 1 7/8" floor and ceiling runners with two 1 1/4" Type S drywall screws at floor and ceiling runners and stud flanges inserted in the kerfed panel edges. Aluminum trim strips screw attached 12" o.c. through panel into ceiling runner. An aluminum or steel one-piece combination runner and trim may be used in lieu of the steel ceiling runner and aluminum trim strips. Aluminum base trim may be used each side of wall with clip attachment.</p> <p>Sound tested with 24" wide panels, one-piece ceiling runner and trim, and 1" mineral fiber insulation in stud space. STC 40 to 44 without mineral fiber insulation. <b>(NLB)</b></p>		<p>Thickness: 3 3/8"                      Approx. Weight: 7 psf                      Fire Test: UC, 8-18-67; UC, 7-23-69;                      WHI-495-0120, 4-5-78;                      UL R1319, 86NK29226, 12-10-86,                      UL Design U427                      Field Sound Test: BBN 701216, 12-22-70;                      BBN 701008, 11-3-70</p>	
<b>PROPRIETARY GYPSUM BOARD</b>			
<p>United States Gypsum Company - 3/4" ULTRAWALL® Gypsum Panels (USG Interiors)</p>			
<b>GA FILE NO. WP 6130</b>	<b>GENERIC</b>	<b>1 HOUR FIRE</b>	<b>40 to 44 STC SOUND</b>
<b>GYPSUM WALLBOARD, STEEL STUDS</b>			
<p>One layer 30" wide 5/8" type X plain or predecorated gypsum wallboard applied parallel to each side of 2 1/2" steel studs 30" o.c. with 1 1/4" Type S drywall screws 30" o.c. Aluminum battens snapped over steel batten retainer strips at each stud and ceiling runner attached with 1 1/4" Type S drywall screws 9" o.c. and steel clips 24" o.c. at floor runner.</p> <p>Sound tested with 2" glass fiber insulation in stud space. <b>(NLB)</b></p>		<p>Thickness: 3 3/4"                      Approx. Weight: 5.5 psf                      Fire Test: FM WP 109, 10-26-67                      Sound Test: NGC 2218, 8-17-67</p>	
<b>GA FILE NO. WP 6135</b>	<b>GENERIC</b>	<b>1 HOUR FIRE</b>	<b>40 to 44 STC SOUND</b>
<b>GYPSUM WALLBOARD, MINERAL FIBER INSULATION, STEEL STUDS</b>			
<p>One layer 1/2" type X plain or predecorated gypsum wallboard applied parallel to each side of 2 1/2" steel studs 24" o.c. with 1" Type S drywall screws 30" o.c. at vertical joints. Aluminum battens attached over each stud with 1" Type S drywall screws 12" o.c. 2" mineral fiber insulation, 2.63 pcf, stapled 24" o.c. in stud space.</p> <p>Joints staggered 24" on opposite sides. <b>(NLB)</b></p>		<p>Thickness: 3 1/2"                      Approx. Weight: 6 psf                      Fire Test: OSU T-4264, 2-9-68                      Sound Test: KG 517, 11-6-68</p>	

\*Contact the manufacturer for more detailed information on proprietary products.



MOVABLE AND OFFICE PARTITIONS				
GA FILE NO. WP 6152	GENERIC	1 HOUR FIRE	40 to 44 STC SOUND	<p align="center"><b>METAL CLAD GYPSUM PANELS, MINERAL FIBER INSULATION, STEEL STUDS</b></p> <p>One layer 30" wide metal faced 1/2" type X gypsum wallboard panels applied parallel to each side of 2 1/2" fabricated steel studs 15" o.c. Metal cladding adhesively attached to wallboard. Studs fabricated from two members joined at webs with tabs and having stud flanges formed to provide spring receiving slots to receive edge flanges of cladding. Two layers 2 1/4" wide 5/8" type X gypsum wallboard strips attached to each side of stud webs. First strip attached with 1 1/4" long Type S drywall screws 12" o.c. Second strip attached with 1 7/8" long Type S drywall screws 24" o.c. and offset 6" from screws in first strip. 2" mineral fiber insulation, 3.8 pcf friction fit in stud cavities. Clad gypsum panels secured at vertical edges to studs by inserting 1 5/16" wide flanges of cladding into stud receiving slot; flanges of cladding are crimped 12" o.c. forming a 3/8" long by 3/32" deep crimp to secure panels to studs. Panels attached to floor and ceiling runners with 1 1/4" Type S drywall screws located 4" from each corner and one in the middle at the bottom.</p> <p>Joints staggered 15" on opposite sides. (NLB)</p>
GA FILE NO. WP 6240	GENERIC	1 HOUR FIRE	35 to 39 STC SOUND	<p align="center"><b>SEMI-SOLID GYPSUM WALLBOARD</b></p> <p><b>Face</b> layer 24" wide 5/8" type X gypsum wallboard laminated parallel to each side of 6" wide 1" gypsum coreboard studs. <b>Face</b> layer joints aligned on opposite sides and offset from stud edges 1 3/4" to form an interlocking joint. Face layer attached to studs with 1 1/2" long Type G screws 30" o.c. spaced 2" from joint on tongue edge and 4" from joint on groove edge. Panels mounted in floor and ceiling channels. (NLB)</p>
GA FILE NO. WP 6250	GENERIC	1 HOUR FIRE	35 to 39 STC SOUND	<p align="center"><b>GYPSUM WALLBOARD, STEEL STUDS</b></p> <p>One layer 5/8" type X predecorated gypsum wallboard applied parallel to each side of 2 1/2" steel studs 24" o.c. with 1" Type S drywall screws 30" o.c. Aluminum battens attached over each stud with 1 1/2" Type S drywall screws 12" o.c. and covered with plastic inserts. 4" snap-on aluminum base applied to bottom edge of assembly.</p> <p>Joints staggered 24" on opposite sides. (NLB)</p>

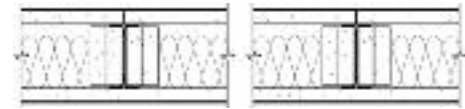

Thickness: 3 1/2"  
 Approx. Weight: 8.5 psf  
 Fire Test: FM WP 495, 11-15-78  
 Sound Test: KAL 443990, 10-31-78



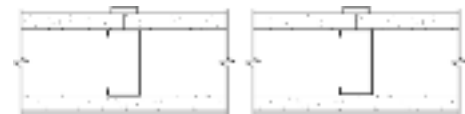

Thickness: 2 1/4"  
 Limiting Height: 12'0"  
 Approx. Weight: 7 psf  
 Fire Test: FM WP 142-1, 1-6-69  
 Sound Test: RAL TL64-212, 4-13-64



Thickness: 3 3/4"  
 Approx. Weight: 5 psf  
 Fire Test: OSU T-2898, 9-17-64  
 Sound Test: OR 64-65, 7-17-64

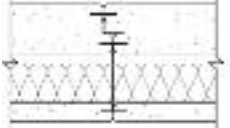
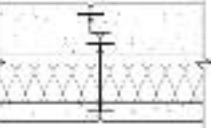

**MOVABLE AND OFFICE PARTITIONS**

GA FILE NO. WP 6254	PROPRIETARY*	1 HOUR FIRE	35 to 39 STC SOUND
<p align="center"><b>GYPSUM WALLBOARD, STEEL STUDS</b></p> <p>One layer 1/2" proprietary type X gypsum wallboard installed parallel to 2 1/2" steel studs 24" o.c. with proprietary clips at vertical joints, 1" Type S drywall screws 8" o.c. at floor and ceiling runners, and 6" wide strips of adhesive 18" o.c. at intermediate studs. Clips attached 10" o.c. to studs at vertical joints with 1/2" Type S panhead screws. One piece of 1/2" proprietary type X gypsum board placed between the studs in stud cavity.</p> <p>Joints staggered 24" on opposite sides. <b>(NLB)</b></p> <p align="center"><b>PROPRIETARY GYPSUM BOARD</b></p> <p>CertainTeed Gypsum Canada Inc. - 1/2" ProRoc® Type C Gypsum Panels</p>			
<p align="center"><b>GYPSUM WALLBOARD, MINERAL FIBER INSULATION, STEEL STUDS</b></p> <p>One layer 24" wide 3/4" kerfed, beveled-edge proprietary gypsum wallboard applied parallel to ONE SIDE of 2 5/8" wide H-studs and 1 7/8" floor and ceiling runners with two 1 1/4" Type S drywall screws at floor and ceiling runners and stud flanges inserted in kerfed panel edges. 1 1/2" mineral fiber insulation, 3.0 pcf, in stud space.</p> <p>OPPOSITE SIDE: <b>Base</b> layer 24" wide 3/4" kerfed, beveled-edge proprietary gypsum wallboard applied parallel to studs with two 1 1/4" Type S drywall screws at floor and ceiling runners and stud flanges inserted in kerfed panel edges. <b>Face</b> layer 24" wide 3/4" kerfed, beveled-edge proprietary gypsum wallboard applied parallel to studs over 2" wide 3/8" gypsum board spacer strips at floor and ceiling runners and 3/4" Z-splines in the kerfed panel edges. Spacer strips attached with 1 5/8" Type S drywall screws 24" o.c. <b>Face</b> layer attached to floor and ceiling runners with two 2 3/8" Type S drywall screws per panel. Z-splines attached to H-studs with screws 24" o.c.</p> <p>1 1/4" wide metal trim strips screw-attached both faces at ceiling runner. <b>(NLB)</b></p> <p align="center"><b>PROPRIETARY GYPSUM BOARD</b></p> <p>United States Gypsum Company - 3/4" ULTRAWALL® Gypsum Panels (USG Interiors)</p>			
<p><b>This Space Left Blank</b></p>			

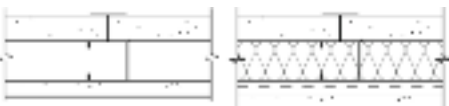
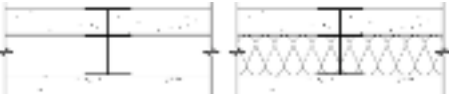
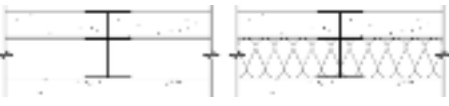
\*Contact the manufacturer for more detailed information on proprietary products.

<b>SHAFT WALLS</b>			
<b>GA FILE NO. WP 6800</b>	<b>PROPRIETARY*</b>	<b>1 HOUR FIRE</b>	<b>45 to 49 STC SOUND</b>
<p style="text-align: center;"><b>GYPSUM WALLBOARD, STEEL C-T STUDS</b></p> <p>One layer 1" x 24" proprietary type X gypsum panels inserted between 2 1/2" floor and ceiling runners with T section of 2 1/2" steel C-T studs between panels.</p> <p>OPPOSITE SIDE: One layer 5/8" proprietary type X gypsum wallboard applied parallel to studs with 1" Type S drywall screws 12" o.c.</p> <p>Sound tested with horizontal resilient channels 24" o.c. and 2 1/2" glass fiber friction fit in stud space. <b>(NLB)</b></p>			
<p style="text-align: center;"><b>PROPRIETARY GYPSUM BOARD</b></p> <p>PABCO Gypsum - 5/8" FLAME CURB® Super 'C'™                  - 1" PABCORE® Gypsum Liner Board</p>		<p>Thickness: 3 1/8"                  Approx. Weight: 7 psf                  Fire Test: WHI-495-1303, 7-19-95                  Sound Test: RAL TL96-28, 2-13-96</p>	
<b>GA FILE NO. WP 6850</b>	<b>PROPRIETARY*</b>	<b>1 HOUR FIRE</b>	<b>40 to 44 STC SOUND</b>
<p style="text-align: center;"><b>GYPSUM WALLBOARD, STEEL C-T OR I STUDS</b></p> <p>One layer 1" x 24" proprietary type X gypsum panels inserted between 2 1/2" floor and ceiling runners with tab-flange section of 2 1/2" steel C-T or I studs between panels.</p> <p>OPPOSITE SIDE: One layer 5/8" proprietary type X gypsum wallboard applied parallel to studs with 1" Type S drywall screws 8" o.c. at edges and 12" o.c. at intermediate studs.</p> <p>Sound tested with 1 1/2" glass fiber insulation friction fit in stud space. <b>(NLB)</b></p>			
<p style="text-align: center;"><b>PROPRIETARY GYPSUM BOARD</b></p> <p>CertainTeed Gypsum Inc. - 5/8" ProRoc® Type X Gypsum Panels                  - 1" ProRoc® Shaftliner Type X Gypsum Panels</p>		<p>Thickness: 3 1/8"                  Approx. Weight: 7 psf                  Fire Test: UL R8701, 98NK33190, 7-12-99, UL Design U417                  Sound Test: NGC 2006036, 1-31-07</p>	
<b>GA FILE NO. WP 6905</b>	<b>PROPRIETARY*</b>	<b>1 HOUR FIRE</b>	<b>40 to 44 STC SOUND</b>
<p style="text-align: center;"><b>GYPSUM WALLBOARD, STEEL C-H, C-T, OR I STUDS</b></p> <p>One layer 1" x 24" proprietary type X gypsum panels inserted between 2 1/2" floor and ceiling J runners with tab-flange section of 2 1/2" steel C-H, C-T, or I studs between panels.</p> <p>OPPOSITE SIDE: One layer 5/8" proprietary type X gypsum wallboard or gypsum veneer base applied parallel or at right angles to studs with 1" Type S drywall screws 12" o.c.</p> <p>Sound tested with 1 1/2" glass fiber insulation friction fit in stud space. <b>(NLB)</b></p>			
<p style="text-align: center;"><b>PROPRIETARY GYPSUM BOARD</b></p> <p>National Gypsum Company - 5/8" Gold Bond® Brand FIRE-SHIELD® Gypsum Wallboard                  - 1" Gold Bond® Brand FIRE-SHIELD® Shaftliner</p>		<p>Thickness: 3 1/8"                  Approx. Weight: 7 psf                  Fire Test: UL R3501, 93NK22748, 9-15-93; 97NK24041, 7-14-97; UL Design U499; FM WP-755,2-27-85                  Sound Test: NGC 2542, 5-11-76</p>	



*\*Contact the manufacturer for more detailed information on proprietary products.*

<b>SHAFT WALLS</b>																								
<b>GA FILE NO. WP 7001</b>	<b>PROPRIETARY*</b>	<b>1 HOUR FIRE</b>	<b>35 to 39 STC SOUND</b>																					
<p style="text-align: center;"><b>GYPSUM PANEL PRODUCTS, STEEL C-H, C-T, OR I STUDS</b></p> <p>One layer 1" x 24" proprietary type X gypsum panels inserted between 2 1/2" floor and ceiling J runners with T section of 2 1/2" proprietary C-H, C-T, or I steel studs between panels.</p> <p>OPPOSITE SIDE: One layer 5/8" proprietary type X gypsum wallboard applied parallel to studs with 1" Type S drywall screws 8" o.c. at edges and 12" o.c. at intermediate studs. <b>(NLB)</b></p> <p style="text-align: center;"><b>PROPRIETARY GYPSUM PANEL PRODUCTS</b></p> <table border="0"> <tr> <td>Georgia-Pacific Gypsum LLC</td> <td>-</td> <td>5/8" ToughRock® Fireguard®</td> </tr> <tr> <td></td> <td>-</td> <td>1" DensGlass® Ultra Shaftliner</td> </tr> </table>		Georgia-Pacific Gypsum LLC	-	5/8" ToughRock® Fireguard®		-	1" DensGlass® Ultra Shaftliner		<p>Thickness: 3 1/8"</p> <p>Approx. Weight: 7 psf</p> <p>Fire Test: GET, 1-7-74; ITS, 8-30-01, ITS Design GP/WA 60-1</p> <p>Sound Test: Estimated</p>															
Georgia-Pacific Gypsum LLC	-	5/8" ToughRock® Fireguard®																						
	-	1" DensGlass® Ultra Shaftliner																						
<b>GA FILE NO. WP 7008</b>	<b>PROPRIETARY*</b>	<b>1 HOUR FIRE</b>	<b>35 to 39 STC SOUND</b>																					
<p style="text-align: center;"><b>GYPSUM WALLBOARD, STEEL C-H STUDS</b></p> <p>One layer 1" x 24" proprietary type X gypsum panels inserted between 2 1/2" floor and ceiling J runners with H section of 2 1/2" proprietary vented C-H steel studs between panels.</p> <p>OPPOSITE SIDE: One layer 5/8" proprietary type X gypsum wallboard or gypsum veneer base applied parallel to studs with 1" Type S drywall screws 12" o.c.</p> <p>STC estimate based on 1" mineral fiber insulation in stud space. <b>(NLB)</b></p> <p style="text-align: center;"><b>PROPRIETARY GYPSUM BOARD</b></p> <table border="0"> <tr> <td>American Gypsum Company LLC</td> <td>-</td> <td>5/8" FireBloc® Type X</td> </tr> <tr> <td>CertainTeed Gypsum Inc.</td> <td>-</td> <td>5/8" ProRoc® Type C Gypsum Panels</td> </tr> <tr> <td>Lafarge North America Inc.</td> <td>-</td> <td>5/8" Firecheck® Type C</td> </tr> <tr> <td>PABCO Gypsum</td> <td>-</td> <td>5/8" FLAME CURB® Type X</td> </tr> <tr> <td>Temple-Inland</td> <td>-</td> <td>5/8" Type X</td> </tr> <tr> <td>United States Gypsum Company</td> <td>-</td> <td>5/8" SHEETROCK® Brand FIRECODE® Core Gypsum Panels</td> </tr> <tr> <td></td> <td>-</td> <td>1" SHEETROCK® Brand Gypsum Liner Panels</td> </tr> </table>		American Gypsum Company LLC	-	5/8" FireBloc® Type X	CertainTeed Gypsum Inc.	-	5/8" ProRoc® Type C Gypsum Panels	Lafarge North America Inc.	-	5/8" Firecheck® Type C	PABCO Gypsum	-	5/8" FLAME CURB® Type X	Temple-Inland	-	5/8" Type X	United States Gypsum Company	-	5/8" SHEETROCK® Brand FIRECODE® Core Gypsum Panels		-	1" SHEETROCK® Brand Gypsum Liner Panels		<p>Thickness: 3 1/8"</p> <p>Approx. Weight: 8 psf</p> <p>Fire Test: UL R1319, 88NK2747, 2-8-88, UL Design U469</p> <p>Sound Test: Estimated</p>
American Gypsum Company LLC	-	5/8" FireBloc® Type X																						
CertainTeed Gypsum Inc.	-	5/8" ProRoc® Type C Gypsum Panels																						
Lafarge North America Inc.	-	5/8" Firecheck® Type C																						
PABCO Gypsum	-	5/8" FLAME CURB® Type X																						
Temple-Inland	-	5/8" Type X																						
United States Gypsum Company	-	5/8" SHEETROCK® Brand FIRECODE® Core Gypsum Panels																						
	-	1" SHEETROCK® Brand Gypsum Liner Panels																						
<b>GA FILE NO. WP 7023</b>	<b>PROPRIETARY*</b>	<b>1 HOUR FIRE</b>																						
<p style="text-align: center;"><b>GYPSUM WALLBOARD, STEEL I, C-H, OR C-T STUDS</b></p> <p>One layer 1" x 24" proprietary type X gypsum panels inserted between 2 1/2" floor and ceiling J runners with tab-flange section of 2 1/2" steel I, C-H, or C-T stud between panels.</p> <p>OPPOSITE SIDE: One layer 5/8" proprietary type X gypsum wallboard or gypsum veneer base applied parallel to studs with 1" Type S drywall screws 12" o.c. <b>(NLB)</b></p> <p style="text-align: center;"><b>PROPRIETARY GYPSUM BOARD</b></p> <table border="0"> <tr> <td>American Gypsum Company LLC</td> <td>-</td> <td>5/8" FireBloc® Type X</td> </tr> <tr> <td></td> <td>-</td> <td>1" Shaftliner</td> </tr> </table>		American Gypsum Company LLC	-	5/8" FireBloc® Type X		-	1" Shaftliner		<p>Thickness: 3 1/8"</p> <p>Approx. Weight: 7 psf</p> <p>Fire Test: UL R14196, 05NK29331, 2-18-06, UL Design V455</p>															
American Gypsum Company LLC	-	5/8" FireBloc® Type X																						
	-	1" Shaftliner																						

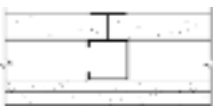
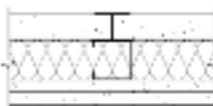
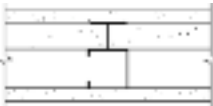
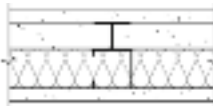
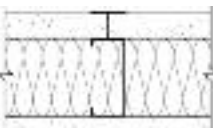
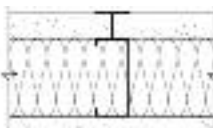
\*Contact the manufacturer for more detailed information on proprietary products.

SHAFT WALLS																																
<b>GA FILE NO. WP 7051</b>	<b>PROPRIETARY*</b>	<b>2 HOUR FIRE</b>	<b>50 to 54 STC SOUND</b>																													
<p align="center"><b>GYPHUM WALLBOARD, STEEL C-H OR C-T STUDS</b></p> <p>One layer 1" x 24" proprietary type X gypsum panels inserted between 2 1/2" floor and ceiling J runners with T section of 2 1/2" steel C-H or C-T studs between panels.</p> <p>OPPOSITE SIDE: <b>Base</b> layer 1/2" proprietary type X gypsum wallboard applied at right angles to studs with 1" Type S drywall screws 24" o.c. <b>Face</b> layer 1/2" proprietary type X gypsum wallboard applied parallel to studs with 1 5/8" Type S drywall screws 12" o.c.</p> <p>Sound tested with 1 7/8" glass fiber insulation in stud space. <b>(NLB)</b></p> <p align="center"><b>PROPRIETARY GYPHUM BOARD</b></p> <table border="0"> <tr> <td>American Gypsum Company LLC</td> <td>-</td> <td>1/2" FireBloc® Type C</td> </tr> <tr> <td></td> <td>-</td> <td>1" Shaft Liner</td> </tr> <tr> <td>CertainTeed Gypsum Inc.</td> <td>-</td> <td>1/2" ProRoc® Type C Gypsum Panels</td> </tr> <tr> <td></td> <td>-</td> <td>1" GlasRoc® Shaftliner Gypsum Panels</td> </tr> <tr> <td>National Gypsum Company</td> <td>-</td> <td>1/2" Gold Bond® Brand FIRE-SHIELD C™ Gypsum Board</td> </tr> <tr> <td></td> <td>-</td> <td>1" Gold Bond® Brand FIRE-SHIELD® Shaftliner</td> </tr> <tr> <td>PABCO Gypsum</td> <td>-</td> <td>1/2" FLAME CURB® Super 'C'™</td> </tr> <tr> <td></td> <td>-</td> <td>1" PABCORE® Gypsum Liner Board</td> </tr> <tr> <td>Temple-Inland</td> <td>-</td> <td>1/2" TG-C</td> </tr> <tr> <td></td> <td>-</td> <td>1" Silent Guard™ Gypsum Liner Board</td> </tr> </table>		American Gypsum Company LLC	-	1/2" FireBloc® Type C		-	1" Shaft Liner	CertainTeed Gypsum Inc.	-	1/2" ProRoc® Type C Gypsum Panels		-	1" GlasRoc® Shaftliner Gypsum Panels	National Gypsum Company	-	1/2" Gold Bond® Brand FIRE-SHIELD C™ Gypsum Board		-	1" Gold Bond® Brand FIRE-SHIELD® Shaftliner	PABCO Gypsum	-	1/2" FLAME CURB® Super 'C'™		-	1" PABCORE® Gypsum Liner Board	Temple-Inland	-	1/2" TG-C		-	1" Silent Guard™ Gypsum Liner Board	  <p>Thickness: 3 1/2"                  Approx. Weight: 9 psf                  Fire Test: UL R7094, 93NK8151, 9-14-93;                  UL R3660, 07NK22992, 2-18-08;                  UL Design U428                  Sound Test: RAL TL93-181, 7-1-93</p>
American Gypsum Company LLC	-	1/2" FireBloc® Type C																														
	-	1" Shaft Liner																														
CertainTeed Gypsum Inc.	-	1/2" ProRoc® Type C Gypsum Panels																														
	-	1" GlasRoc® Shaftliner Gypsum Panels																														
National Gypsum Company	-	1/2" Gold Bond® Brand FIRE-SHIELD C™ Gypsum Board																														
	-	1" Gold Bond® Brand FIRE-SHIELD® Shaftliner																														
PABCO Gypsum	-	1/2" FLAME CURB® Super 'C'™																														
	-	1" PABCORE® Gypsum Liner Board																														
Temple-Inland	-	1/2" TG-C																														
	-	1" Silent Guard™ Gypsum Liner Board																														
<b>GA FILE NO. WP 7052</b>	<b>PROPRIETARY*</b>	<b>2 HOUR FIRE</b>	<b>50 to 54 STC SOUND</b>																													
<p align="center"><b>GYPHUM WALLBOARD, STEEL C-H OR C-T STUDS</b></p> <p>One layer 1" x 24" proprietary type X gypsum panels inserted between 2 1/2" floor and ceiling J runners with T section of 2 1/2" steel C-H or C-T studs between panels. <b>Face</b> layer 1/2" proprietary type X gypsum wallboard applied parallel to studs with vertical joints midway between studs and laminated to proprietary gypsum panels with 4" wide strips of taping compound at wallboard perimeter and vertical centerline. 1 1/2" Type G drywall screws 24" o.c. located 1 1/2" back from wallboard edges and at vertical centerline.</p> <p>OPPOSITE SIDE: One layer 1/2" proprietary type X gypsum wallboard applied at right angles to studs with 1" Type S drywall screws 24" o.c.</p> <p>Sound tested with 1 7/8" glass fiber insulation in stud space. <b>(NLB)</b></p> <p align="center"><b>PROPRIETARY GYPHUM BOARD</b></p> <table border="0"> <tr> <td>American Gypsum Company LLC</td> <td>-</td> <td>1/2" FireBloc® Type C</td> </tr> <tr> <td></td> <td>-</td> <td>1" Shaft Liner</td> </tr> <tr> <td>PABCO Gypsum</td> <td>-</td> <td>1/2" FLAME CURB® Super 'C'™</td> </tr> <tr> <td></td> <td>-</td> <td>1" PABCORE® Gypsum Liner Board</td> </tr> <tr> <td>Temple-Inland</td> <td>-</td> <td>1/2" TG-C</td> </tr> <tr> <td></td> <td>-</td> <td>1" Silent Guard™ Gypsum Liner Board</td> </tr> </table>		American Gypsum Company LLC	-	1/2" FireBloc® Type C		-	1" Shaft Liner	PABCO Gypsum	-	1/2" FLAME CURB® Super 'C'™		-	1" PABCORE® Gypsum Liner Board	Temple-Inland	-	1/2" TG-C		-	1" Silent Guard™ Gypsum Liner Board	  <p>Thickness: 3 1/2"                  Approx. Weight: 9 psf                  Fire Test: See WP 7051 (UL R7094, 93NK8151, 9-14-93, UL Design U429)                  Sound Test: See WP 7051 (RAL TL93-181, 7-1-93)</p>												
American Gypsum Company LLC	-	1/2" FireBloc® Type C																														
	-	1" Shaft Liner																														
PABCO Gypsum	-	1/2" FLAME CURB® Super 'C'™																														
	-	1" PABCORE® Gypsum Liner Board																														
Temple-Inland	-	1/2" TG-C																														
	-	1" Silent Guard™ Gypsum Liner Board																														
<b>GA FILE NO. WP 7053</b>	<b>PROPRIETARY*</b>	<b>2 HOUR FIRE</b>	<b>50 to 54 FSTC SOUND</b>																													
<p align="center"><b>GYPHUM WALLBOARD, STEEL C-H STUDS, MINERAL FIBER INSULATION</b></p> <p>One layer 1" x 24" proprietary type X gypsum liner panels inserted between 4" floor and ceiling J runners with H section of 4" proprietary vented C-H steel studs between panels. 3" proprietary mineral fiber insulation, 2.0 pcf, in stud space. When wall height exceeds liner panel length, liner panels are butted to extend to the full height of the wall. Horizontal joints need not be backed by steel framing.</p> <p>OPPOSITE SIDE: One layer 3/4" proprietary type X gypsum wallboard applied parallel or at right angles to studs with 1 1/4" Type S drywall screws 8" o.c. at vertical edges and 12" o.c. at intermediate studs when installed parallel to studs or 8" o.c. at vertical end joints and intermediate studs when applied at right angles to studs. Horizontal joints need not be backed by steel framing. <b>(NLB)</b></p> <p align="center"><b>PROPRIETARY GYPHUM BOARD</b></p> <table border="0"> <tr> <td>United States Gypsum Company</td> <td>-</td> <td>3/4" SHEETROCK® Brand ULTRACODE® Core Gypsum Panels</td> </tr> <tr> <td></td> <td>-</td> <td>1" SHEETROCK® Brand Gypsum Liner Panels</td> </tr> </table>		United States Gypsum Company	-	3/4" SHEETROCK® Brand ULTRACODE® Core Gypsum Panels		-	1" SHEETROCK® Brand Gypsum Liner Panels	  <p>Thickness: 4 3/4"                  Approx. Weight: 8 psf                  Fire Test: UL R1319, 97NK33240, 11-20-97,                  UL Design U415 - System C                  Field Sound Test: SA-910913, 9-12-91</p>																								
United States Gypsum Company	-	3/4" SHEETROCK® Brand ULTRACODE® Core Gypsum Panels																														
	-	1" SHEETROCK® Brand Gypsum Liner Panels																														

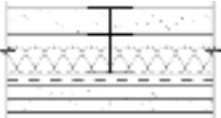
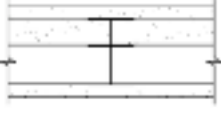
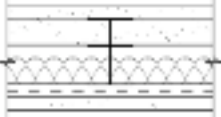

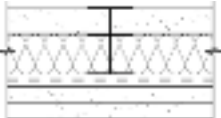
*\*Contact the manufacturer for more detailed information on proprietary products.*

<b>SHAFT WALLS</b>								
<b>GA FILE NO. WP 7056</b>	<b>PROPRIETARY*</b>	<b>2 HOUR FIRE</b>	<b>50 to 54 STC SOUND</b>					
<p style="text-align: center;"><b>GYPSUM BOARD, SLOTTED STEEL I OR C-T STUDS</b></p> <p>One layer 1" x 24" proprietary type X gypsum panels inserted between 2 1/2" floor and ceiling runners with tab-flange section of 2 1/2" slotted steel I or C-T studs between panels.</p> <p>OPPOSITE SIDE: <b>Base</b> layer 1/2" proprietary type X gypsum wallboard or gypsum veneer base applied at right angles to studs with 1" Type S drywall screws 24" o.c. <b>Face</b> layer 1/2" proprietary type X gypsum wallboard or veneer base applied parallel to studs with 1 5/8" Type S drywall screws 12" o.c.</p> <p>Sound tested with horizontal resilient channels 24" o.c. and 1" glass fiber insulation friction fit in stud space. <b>(NLB)</b></p> <p style="text-align: center;"><b>PROPRIETARY GYPSUM BOARD</b></p> <table border="0"> <tr> <td style="padding-right: 20px;">CertainTeed Gypsum Inc.</td> <td>-</td> <td>1/2" ProRoc® Type C Gypsum Panels</td> </tr> <tr> <td></td> <td>-</td> <td>1" ProRoc® Shaftliner Type X Gypsum Panels</td> </tr> </table>		CertainTeed Gypsum Inc.	-	1/2" ProRoc® Type C Gypsum Panels		-	1" ProRoc® Shaftliner Type X Gypsum Panels	  <p>Thickness: 3 1/2" (Fire) 4" (Sound)</p> <p>Approx. Weight: 9 psf</p> <p>Fire Test: UL R8701, 98NK33190, 7-12-99, UL Design U417</p> <p>Sound Test: Estimated, see WP 7057 (WEAL 84-107, 3-16-84)</p>
CertainTeed Gypsum Inc.	-	1/2" ProRoc® Type C Gypsum Panels						
	-	1" ProRoc® Shaftliner Type X Gypsum Panels						
<b>GA FILE NO. WP 7057</b>	<b>PROPRIETARY*</b>	<b>2 HOUR FIRE</b>	<b>50 to 54 STC SOUND</b>					
<p style="text-align: center;"><b>GYPSUM WALLBOARD, SLOTTED STEEL I OR C-T STUDS</b></p> <p>One layer 1" x 24" proprietary type X gypsum panels inserted between 2 1/2" floor and ceiling runners with tab-flange section of 2 1/2" slotted steel I or C-T studs between panels. One layer 1/2" proprietary type X gypsum wallboard or gypsum veneer base applied parallel to each side with 1" Type S drywall screws 12" o.c.</p> <p>Sound tested with horizontal resilient channels 24" o.c. and 1" glass fiber insulation friction fit in stud space. <b>(NLB)</b></p> <p style="text-align: center;"><b>PROPRIETARY GYPSUM BOARD</b></p> <table border="0"> <tr> <td style="padding-right: 20px;">CertainTeed Gypsum Inc.</td> <td>-</td> <td>1/2" ProRoc® Type C Gypsum Panels</td> </tr> <tr> <td></td> <td>-</td> <td>1" ProRoc® Shaftliner Type X Gypsum Panels</td> </tr> </table>		CertainTeed Gypsum Inc.	-	1/2" ProRoc® Type C Gypsum Panels		-	1" ProRoc® Shaftliner Type X Gypsum Panels	  <p>Thickness: 3 1/2" (Fire) 4" (Sound)</p> <p>Approx. Weight: 9 psf</p> <p>Fire Test: UL R8701, 98NK33190, 7-12-99, UL Design U417</p> <p>Sound Test: WEAL 84-107, 3-16-84</p>
CertainTeed Gypsum Inc.	-	1/2" ProRoc® Type C Gypsum Panels						
	-	1" ProRoc® Shaftliner Type X Gypsum Panels						
<b>GA FILE NO. WP 7060</b>	<b>PROPRIETARY*</b>	<b>2 HOUR FIRE</b>	<b>50 to 54 STC SOUND</b>					
<p style="text-align: center;"><b>GYPSUM WALLBOARD, STEEL C-H, C-T, OR I STUDS</b></p> <p>One layer 1" x 24" proprietary type X gypsum panels inserted between 2 1/2" floor and ceiling runners with tab-flange section of 2 1/2" steel C-H, C-T, or I studs between panels.</p> <p>OPPOSITE SIDE: <b>Base</b> layer 5/8" proprietary type X gypsum wallboard or gypsum veneer base applied parallel to studs with 1" Type S drywall screws 24" o.c. <b>Face</b> layer 5/8" proprietary type X gypsum wallboard or gypsum veneer base applied parallel to studs with 1 5/8" Type S drywall screws 12" o.c.</p> <p>Sound tested with horizontal resilient channels 24" o.c. and 1 1/2" glass fiber insulation friction fit in stud space. <b>(NLB)</b></p> <p style="text-align: center;"><b>PROPRIETARY GYPSUM BOARD</b></p> <table border="0"> <tr> <td style="padding-right: 20px;">National Gypsum Company</td> <td>-</td> <td>5/8" Gold Bond® Brand FIRE-SHIELD® Gypsum Board</td> </tr> <tr> <td></td> <td>-</td> <td>1" Gold Bond® Brand FIRE-SHIELD® Shaftliner</td> </tr> </table>		National Gypsum Company	-	5/8" Gold Bond® Brand FIRE-SHIELD® Gypsum Board		-	1" Gold Bond® Brand FIRE-SHIELD® Shaftliner	  <p>Thickness: 3 3/4" (Fire) 4 1/4" (Sound)</p> <p>Approx. Weight: 9 psf</p> <p>Fire Test: UC ES-7408, 11-21-75 (Rev 6-76); UL Design U497</p> <p>Sound Test: KAL 437362, 11-3-76</p>
National Gypsum Company	-	5/8" Gold Bond® Brand FIRE-SHIELD® Gypsum Board						
	-	1" Gold Bond® Brand FIRE-SHIELD® Shaftliner						

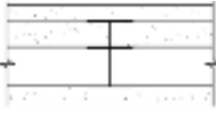
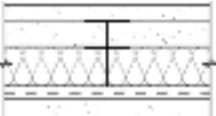
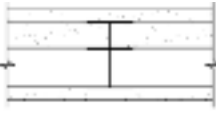
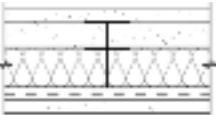
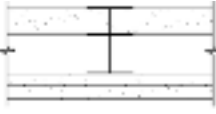
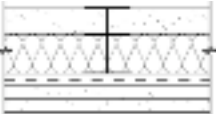
\*Contact the manufacturer for more detailed information on proprietary products.

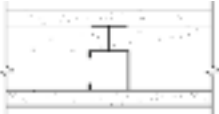
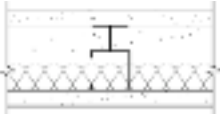
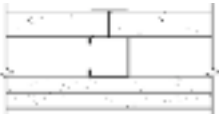

<b>SHAFT WALLS</b>			
<b>GA FILE NO. WP 7061</b>	<b>PROPRIETARY*</b>	<b>2 HOUR FIRE</b>	<b>50 to 54 STC SOUND</b>
<p style="text-align: center;"><b>GYPSUM WALLBOARD, STEEL C-H, C-T, OR I STUDS</b></p> <p>One layer 1" x 24" proprietary type X gypsum panels inserted between 2 1/2" floor and ceiling runners with tab-flange section of 2 1/2" steel C-H, C-T, or I studs between panels. One layer 5/8" proprietary type X gypsum wallboard or gypsum veneer base applied parallel or at right angles to each side with 1" Type S drywall screws 12" o.c.</p> <p>Sound tested with horizontal resilient channels 24" o.c. and 1 1/2" glass fiber insulation friction fit in stud space. <b>(NLB)</b></p> <p style="text-align: center;"><b>PROPRIETARY GYPSUM BOARD</b></p> <p>National Gypsum Company - 5/8" Gold Bond® Brand FIRE-SHIELD® Gypsum Board                      - 1" Gold Bond® Brand FIRE-SHIELD® Shaftliner</p>			
		<p>Thickness: 3 3/4" (Fire) 4 1/4" (Sound)</p> <p>Approx. Weight: 9 psf</p> <p>Fire Test: UC ES-7407, 1-22-76; UL Design U498</p> <p>Sound Test: KAL 437363, 11-4-76</p>	
<b>GA FILE NO. WP 7062</b>	<b>PROPRIETARY*</b>	<b>2 HOUR FIRE</b>	<b>50 to 54 STC SOUND</b>
<p style="text-align: center;"><b>GYPSUM WALLBOARD, STEEL C-H, C-T, OR I STUDS</b></p> <p>One layer 1" x 24" proprietary type X gypsum panels inserted between 2 1/2" floor and ceiling runners with tab-flange section of 2 1/2" steel C-H, C-T, or I studs between panels. One layer 1/2" proprietary type X gypsum wallboard or gypsum veneer base applied parallel or at right angles to each side with 1" Type S drywall screws 12" o.c.</p> <p>Sound tested with horizontal resilient channels 24" o.c. and 1 1/2" glass fiber insulation friction fit in stud space. <b>(NLB)</b></p> <p style="text-align: center;"><b>PROPRIETARY GYPSUM BOARD</b></p> <p>National Gypsum Company - 1/2" Gold Bond® Brand FIRE-SHIELD C™ Gypsum Board                      - 1" Gold Bond® Brand FIRE-SHIELD® Shaftliner</p>			
		<p>Thickness: 3 1/2" (Fire) 4" (Sound)</p> <p>Approx. Weight: 9 psf</p> <p>Fire Test: See WP 7079 (UL R3501, 93NK22748, 9-15-93; 97NK4588, 1-30-97; 97NK5247, 2-4-97; UL Design U498; FM WP-545, 12-22-81)</p> <p>Sound Test: BBN NGC 2610, 4-15-82</p>	
<b>GA FILE NO. WP 7064</b>	<b>PROPRIETARY*</b>	<b>2 HOUR FIRE</b>	<b>50 to 54 STC SOUND</b>
<p style="text-align: center;"><b>GYPSUM WALLBOARD, STEEL C-H, C-T, OR I STUDS</b></p> <p>One layer 1" x 24" proprietary type X gypsum panels inserted between 2 1/2" floor and ceiling runners with tab-flange section of 2 1/2" steel C-H, C-T, or I studs between panels.</p> <p><b>OPPOSITE SIDE: Base</b> layer 1/2" proprietary type X gypsum wallboard or gypsum veneer base applied parallel or at right angles to studs with 1" Type S drywall screws 24" o.c. <b>Face</b> layer 1/2" proprietary type X gypsum wallboard or gypsum veneer base applied either parallel to studs with 1 5/8" Type S drywall screws 12" o.c. or at right angles to studs with 1 5/8" Type S drywall screws 8" o.c. at wall perimeter and vertical joints and 12" o.c. at intermediate studs.</p> <p>Sound tested with horizontal resilient channels 24" o.c. and 1 1/2" glass fiber insulation friction fit in stud space. <b>(NLB)</b></p> <p style="text-align: center;"><b>PROPRIETARY GYPSUM BOARD</b></p> <p>American Gypsum Company LLC - 1/2" FireBloc® Type C                      Lafarge North America Inc. - 1/2" Firecheck® Type C                      National Gypsum Company - 1/2" Gold Bond® Brand FIRE-SHIELD C™ Gypsum Board                      - 1" Gold Bond® Brand FIRE-SHIELD® Shaftliner                      Temple-Inland - 1/2" TG-C</p>			
		<p>Thickness: 3 1/2" (Fire) 4" (Sound)</p> <p>Approx. Weight: 9 psf</p> <p>Fire Test: See WP 7080 (UL R3501, 93NK22748, 9-15-93, UL Design U497; FM WP-636, 10-14-81; WHI-651-0500.05, 3-22-89 &amp; 7-19-89)</p> <p>Sound Test: BBN NGC 2609, 4-15-82</p>	

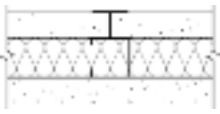
\*Contact the manufacturer for more detailed information on proprietary products.



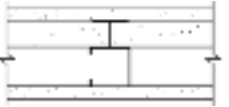
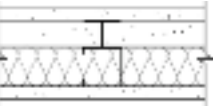
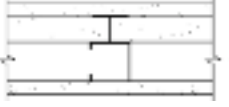
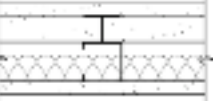

<b>SHAFT WALLS</b>								
<b>GA FILE NO. WP 7069</b>	<b>PROPRIETARY*</b>	<b>2 HOUR FIRE</b>	<b>45 to 49 STC SOUND</b>					
<p style="text-align: center;"><b>GYPSUM PANEL PRODUCTS, STEEL C-T, OR C-H STUDS</b></p> <p>One layer 1" x 24" proprietary type X fiberglass mat gypsum panels inserted between 2 1/2" floor and ceiling runners with tab-flange section of 2 1/2" steel C-T, or C-H studs between panels. One layer 5/8" proprietary type X fiberglass mat gypsum substrate, fiberglass mat water-resistant gypsum backing board, gypsum wallboard or gypsum veneer base applied parallel to each side with 1" Type S drywall screws 12" o.c.</p> <p>Sound tested with 1" glass fiber insulation friction fit in stud space. <b>(NLB)</b></p> <p style="text-align: center;"><b>PROPRIETARY GYPSUM PANEL PRODUCTS</b></p> <table border="0"> <tr> <td>Georgia-Pacific Gypsum LLC</td> <td>-</td> <td>5/8" ToughRock® Fireguard®</td> </tr> <tr> <td></td> <td>-</td> <td>1" Ultraliner® Shaftliner</td> </tr> </table>		Georgia-Pacific Gypsum LLC	-	5/8" ToughRock® Fireguard®		-	1" Ultraliner® Shaftliner	  <p>Thickness: 3 3/4"                  Approx. Weight: 9 psf                  Fire Test: UL R2717, 08NK012297, 9-11-08                  UL Design V473                  Sound Test: RAL TL89-379, 11-7-89</p>
Georgia-Pacific Gypsum LLC	-	5/8" ToughRock® Fireguard®						
	-	1" Ultraliner® Shaftliner						
<b>GA FILE NO. WP 7070</b>	<b>PROPRIETARY*</b>	<b>2 HOUR FIRE</b>	<b>45 to 49 STC SOUND</b>					
<p style="text-align: center;"><b>GYPSUM PANEL PRODUCTS, STEEL C-T, OR C-H STUDS</b></p> <p>One layer 1" x 24" proprietary type X fiberglass mat gypsum panels inserted between 2 1/2" floor and ceiling runners with tab-flange section of 2 1/2" steel C-T, or C-H studs between panels.</p> <p>OPPOSITE SIDE: <b>Base</b> layer 5/8" proprietary type X fiberglass mat gypsum substrate, fiberglass mat water-resistant gypsum backing board, gypsum wallboard or gypsum veneer base applied parallel or at right angles to studs with 1" Type S drywall screws 24" o.c. <b>Face</b> layer 5/8" proprietary type X fiberglass mat gypsum substrate, fiberglass mat water-resistant gypsum backing board, gypsum wallboard or gypsum veneer base applied parallel to studs with 1 5/8" Type S drywall screws 24" o.c. along top and bottom tracks and 12" o.c. at vertical joints and intermediate studs. Face layer joints offset 24" from base layer joints.</p> <p>Sound tested with 1" glass fiber insulation friction fit in stud space. <b>(NLB)</b></p> <p style="text-align: center;"><b>PROPRIETARY GYPSUM PANEL PRODUCTS</b></p> <table border="0"> <tr> <td>Georgia-Pacific Gypsum LLC</td> <td>-</td> <td>5/8" ToughRock® Fireguard®</td> </tr> <tr> <td></td> <td>-</td> <td>1" Ultraliner® Shaftliner</td> </tr> </table>		Georgia-Pacific Gypsum LLC	-	5/8" ToughRock® Fireguard®		-	1" Ultraliner® Shaftliner	  <p>Thickness: 3 3/4"                  Approx. Weight: 9 psf                  Fire Test: UL R2717, 08NK012297, 9-11-08                  UL Design V473                  Sound Test: RAL TL89-379, 11-7-89</p>
Georgia-Pacific Gypsum LLC	-	5/8" ToughRock® Fireguard®						
	-	1" Ultraliner® Shaftliner						
<b>GA FILE NO. WP 7071</b>	<b>PROPRIETARY*</b>	<b>2 HOUR FIRE</b>	<b>45 to 49 STC SOUND</b>					
<p style="text-align: center;"><b>GYPSUM WALLBOARD, STEEL C-T STUDS</b></p> <p>One layer 1" x 24" proprietary type X gypsum panels inserted between 2 1/2" floor and ceiling J runners with T section of 2 1/2" steel C-T studs between panels.</p> <p>OPPOSITE SIDE: <b>Base</b> layer 1/2" proprietary type X gypsum wallboard applied at right angles to studs with 1" Type S drywall screws 24" o.c. and 3" from floor and ceiling runners. <b>Face</b> layer 1/2" proprietary type X gypsum wallboard applied parallel to studs with 1 5/8" Type S drywall screws 12" o.c. and 6" from floor and ceiling runners.</p> <p>Sound tested with 1 1/2" mineral fiber insulation friction fit in stud spaces. <b>(NLB)</b></p> <p style="text-align: center;"><b>PROPRIETARY GYPSUM BOARD</b></p> <table border="0"> <tr> <td>Lafarge North America Inc.</td> <td>-</td> <td>1/2" Firecheck® Type C</td> </tr> <tr> <td></td> <td>-</td> <td>1" Mold Defense® Shaftliner</td> </tr> </table>		Lafarge North America Inc.	-	1/2" Firecheck® Type C		-	1" Mold Defense® Shaftliner	  <p>Thickness: 3 1/2"                  Approx. Weight: 9 psf                  Fire Test: WHI-495-1404/1405/1408/1409, 5-15-98;                  ITS Design LG/WA 120-01                  Sound Test: RAL TL08-169, 6-18-08</p>
Lafarge North America Inc.	-	1/2" Firecheck® Type C						
	-	1" Mold Defense® Shaftliner						

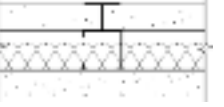
\*Contact the manufacturer for more detailed information on proprietary products.



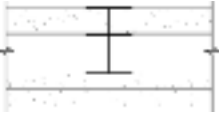
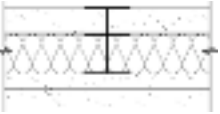

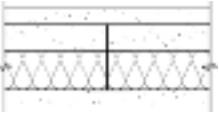
SHAFT WALLS				
GA FILE NO. WP 7072	PROPRIETARY*	2 HOUR FIRE	45 to 49 STC SOUND	<p align="center"><b>GYPSUM WALLBOARD, STEEL C-T STUDS</b></p> <p>One layer 1" x 24" proprietary type X gypsum panels inserted between 2 1/2" floor and ceiling J runners with T section of 2 1/2" steel C-T studs between panels. One layer 1/2" proprietary type X gypsum wallboard applied parallel to each side with 1" Type S drywall screws 12" o.c. and 6" from floor and ceiling runners.</p> <p>Joints staggered 24" on opposite sides. <b>(NLB)</b></p> <p>Sound tested with 1 1/2" mineral fiber insulation friction fit in stud spaces.</p> <p align="center"><b>PROPRIETARY GYPSUM BOARD</b></p> <p>Lafarge North America Inc. - 1/2" Firecheck® Type C                      - 1" Mold Defense® Shaftliner</p>
				<p>Thickness: 3 1/2"                      Approx. Weight: 9 psf                      Fire Test: WHI-495-1406/1407/1410/1411, 5-22-98;                      ITS Design LG/WA 120-02                      Sound Test: RAL TL08-173, 6-23-08</p>
GA FILE NO. WP 7073	PROPRIETARY*	2 HOUR FIRE	45 to 49 STC SOUND	<p align="center"><b>GYPSUM PANEL PRODUCTS, STEEL C-H, C-T, OR I STUDS</b></p> <p>One layer 1" x 24" proprietary type X gypsum panels inserted between 2 1/2" floor and ceiling J runners with T section of 2 1/2" steel C-H, C-T, or I studs between panels. One layer 1/2" proprietary type X gypsum wallboard applied parallel to each side with 1" Type S drywall screws 12" o.c.</p> <p>Joints staggered 24" on opposite sides. Sound tested with 1" glass fiber insulation friction fit in stud space. <b>(NLB)</b></p> <p align="center"><b>PROPRIETARY GYPSUM PANEL PRODUCTS</b></p> <p>Georgia-Pacific Gypsum LLC - 1/2" ToughRock® Fireguard C™                      - 1" DensGlass® Ultra Shaftliner™</p>
				<p>Thickness: 3 1/2"                      Approx. Weight: 9 psf                      Fire Test: ITS, 8-30-01,                      ITS Design GP/WA 120-02                      Sound Test: See WP 7097                      (RAL TL89-380, 11-8-89)</p>
GA FILE NO. WP 7074	PROPRIETARY*	2 HOUR FIRE	45 to 49 STC SOUND	<p align="center"><b>GYPSUM PANEL PRODUCTS, STEEL C-H, C-T, OR I STUDS</b></p> <p>One layer 1" x 24" proprietary type X gypsum panels inserted between 2 1/2" floor and ceiling J runners with T section of 2 1/2" steel C-H, C-T, or I studs between panels.</p> <p>OPPOSITE SIDE: <b>Base</b> layer 1/2" proprietary type X gypsum wallboard applied at right angles to studs with 1" Type S drywall screws 24" o.c. and 6" from floor and ceiling runners. <b>Face</b> layer 1/2" proprietary type X gypsum wallboard applied parallel to studs with 1 5/8" Type S drywall screws 12" o.c. and 3" from floor and ceiling runners. Joints offset 24" from base layer joints.</p> <p>Sound tested with 1" glass fiber insulation friction fit in stud space. <b>(NLB)</b></p> <p align="center"><b>PROPRIETARY GYPSUM PANEL PRODUCTS</b></p> <p>Georgia-Pacific Gypsum LLC - 1/2" ToughRock® Fireguard C™                      - 1" DensGlass® Ultra Shaftliner™</p>
				<p>Thickness: 3 1/2"                      Approx. Weight: 9 psf                      Fire Test: ITS, 8-30-01,                      ITS Design GP/WA 120-01                      Sound Test: See WP 7096                      (RAL TL89-379, 11-7-89)</p>

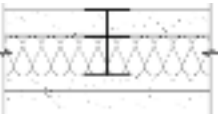
\*Contact the manufacturer for more detailed information on proprietary products.

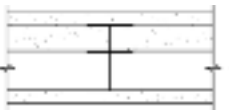
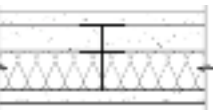

<b>SHAFT WALLS</b>			
<b>GA FILE NO. WP 7076</b>	<b>PROPRIETARY*</b>	<b>2 HOUR FIRE</b>	<b>45 to 49 STC SOUND</b>
<p style="text-align: center;"><b>GYPSUM WALLBOARD, STEEL C-H, C-T, OR I STUDS</b></p> <p>One layer 1" x 24" proprietary type X gypsum panels inserted between 2 1/2" floor and ceiling runners with tab-flange section of 2 1/2" steel C-H, C-T, or I studs between panels.</p> <p>OPPOSITE SIDE: <b>Base</b> layer 5/8" proprietary type X gypsum wallboard or gypsum veneer base applied parallel or at right angles to studs with 1" Type S drywall screws 24" o.c.  <b>Face</b> layer 5/8" proprietary type X gypsum wallboard or gypsum veneer base applied parallel to studs with 1 5/8" Type S drywall screws 12" o.c.</p> <p>Sound tested with 2 1/2" glass fiber insulation friction fit in stud space. <b>(NLB)</b></p> <p style="text-align: center;"><b>PROPRIETARY GYPSUM BOARD</b></p> <p>National Gypsum Company - 5/8" Gold Bond® Brand FIRE-SHIELD® Gypsum Board                      - 1" Gold Bond® Brand FIRE-SHIELD® Shaftliner</p>			
		<p>Thickness: 3 3/4"</p> <p>Approx. Weight: 8.5 psf</p> <p>Fire Test: UC ES-7408, 11-21-75 (Rev. 6-76); UL Design U497</p> <p>Sound Test: NGC 2507, 7-21-75</p>	
<b>GA FILE NO. WP 7077</b>	<b>PROPRIETARY*</b>	<b>2 HOUR FIRE</b>	<b>45 to 49 STC SOUND</b>
<p style="text-align: center;"><b>GYPSUM WALLBOARD, STEEL C-H, C-T, OR I STUDS</b></p> <p>One layer 1" x 24" proprietary type X gypsum panels inserted between 2 1/2" floor and ceiling runners with tab-flange section of 2 1/2" steel C-H, C-T, or I studs between panels. One layer 5/8" proprietary type X gypsum wallboard or gypsum veneer base applied parallel or at right angles to studs on each side with 1" Type S drywall screws 12" o.c.</p> <p>Sound tested with 1 1/2" glass fiber insulation friction fit in stud space. <b>(NLB)</b></p> <p style="text-align: center;"><b>PROPRIETARY GYPSUM BOARD</b></p> <p>National Gypsum Company - 5/8" Gold Bond® Brand FIRE-SHIELD® Gypsum Board                      - 1" Gold Bond® Brand FIRE-SHIELD® Shaftliner</p>			
		<p>Thickness: 3 3/4"</p> <p>Approx. Weight: 8.5 psf</p> <p>Fire Test: UC ES-7407, 1-22-76; UL Design U498</p> <p>Sound Test: NGC 2543, 5-18-76</p>	
<b>GA FILE NO. WP 7078</b>	<b>PROPRIETARY*</b>	<b>2 HOUR FIRE</b>	<b>45 to 49 STC SOUND</b>
<p style="text-align: center;"><b>GYPSUM WALLBOARD, STEEL C-T OR I STUDS</b></p> <p>One layer 1" x 24" proprietary type X gypsum panels inserted between 2 1/2" floor and ceiling runners with tab-flange section of 2 1/2" steel C-T or I studs between panels.</p> <p>OPPOSITE SIDE: <b>Base</b> layer 5/8" proprietary type X gypsum wallboard or gypsum veneer base applied parallel or at right angles to studs with 1" Type S drywall screws 24" o.c.  <b>Face</b> layer 5/8" proprietary type X gypsum wallboard or gypsum veneer base applied at right angles to base layer with 1 5/8" Type S drywall screws 12" o.c.</p> <p>Sound tested with 2 1/2" glass fiber insulation friction fit in stud space. <b>(NLB)</b></p> <p style="text-align: center;"><b>PROPRIETARY GYPSUM BOARD</b></p> <p>CertainTeed Gypsum Inc. - 5/8" ProRoc® Type X Gypsum Panels                      - 1" ProRoc® Shaftliner Type X Gypsum Panels</p>			
		<p>Thickness: 3 3/4"</p> <p>Approx. Weight: 8.5 psf</p> <p>Fire Test: WHI 495-0091, 12-9-77; WHI 495-0095, 12-16-77; UL R8701, 98NK33190, 7-12-99, UL Design U417</p> <p>Sound Test: WHI F2, 3-13-78</p>	

\*Contact the manufacturer for more detailed information on proprietary products.

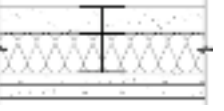
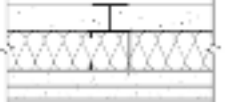
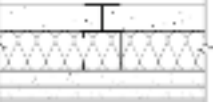

**SHAFT WALLS**

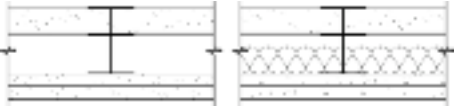
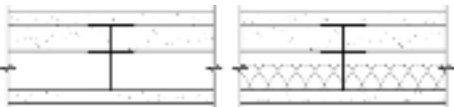
GA FILE NO. WP 7079	PROPRIETARY*	2 HOUR FIRE	45 to 49 STC SOUND
<p align="center"><b>GYPSUM WALLBOARD, STEEL C-H, C-T, OR I STUDS</b></p> <p>One layer 1" x 24" proprietary type X gypsum panels inserted between 2 1/2" floor and ceiling runners with tab-flange section of 2 1/2" steel C-H, C-T, or I studs between panels. One layer 1/2" proprietary type X gypsum wallboard or gypsum veneer base applied parallel or at right angles to each side with 1" Type S drywall screws 12" o.c.</p> <p>Sound tested with 1 1/2" glass fiber insulation friction fit in stud space. <b>(NLB)</b></p> <p align="center"><b>PROPRIETARY GYPSUM BOARD</b></p> <p>National Gypsum Company - 1/2" Gold Bond® Brand FIRE-SHIELD C™ Gypsum Board  - 1" Gold Bond® Brand FIRE-SHIELD® Shaftliner</p>			
<p align="center"><b>GYPSUM WALLBOARD, STEEL C-H, C-T, OR I STUDS</b></p> <p>One layer 1" x 24" proprietary type X gypsum panels inserted between 2 1/2" floor and ceiling runners with tab-flange section of 2 1/2" steel C-H, C-T, or I studs between panels.</p> <p>OPPOSITE SIDE: <b>Base</b> layer 1/2" proprietary type X gypsum wallboard or gypsum veneer base applied at right angles to studs with 1" Type S drywall screws 24" o.c. <b>Face</b> layer 1/2" proprietary type X gypsum wallboard or gypsum veneer base applied either parallel to studs with 1 5/8" Type S drywall screws 12" o.c. or at right angles to studs with 1 5/8" Type S drywall screws 8" o.c. at wall perimeter and vertical joints and 12" o.c. at intermediate studs.</p> <p>Sound tested with 1 1/2" glass fiber insulation friction fit in stud space. <b>(NLB)</b></p> <p align="center"><b>PROPRIETARY GYPSUM BOARD</b></p> <p>American Gypsum Company LLC - 1/2" FireBloc® Type C  Lafarge North America Inc. - 1/2" Firecheck® Type C  National Gypsum Company - 1/2" Gold Bond® Brand FIRE-SHIELD C™ Gypsum Board  - 1" Gold Bond® Brand FIRE-SHIELD® Shaftliner  Temple-Inland - 1/2" TG-C</p>			
<p align="center"><b>GYPSUM WALLBOARD, CEMENTITIOUS BACKER UNITS, STEEL C-H STUDS</b></p> <p>One layer 1" x 24" proprietary type X gypsum liner panels inserted between 2 1/2" floor and ceiling J runners with H section of 2 1/2" 20 gage proprietary vented C-H steel studs between panels. 1 1/2" mineral fiber insulation in stud space. When wall height exceeds liner panel length, liner panels are butted to extend to the full height of the wall. Horizontal joint need not be backed by steel framing.</p> <p>OPPOSITE SIDE: <b>Base</b> layer 5/8" proprietary type X gypsum wallboard applied parallel or at right angles to studs with 1" long Type S drywall screws 24" o.c. when applied parallel to studs or 16" o.c. when applied at right angles to studs <b>Face</b> layer 1/2" or 5/8" proprietary cementitious backer units applied parallel or at right angles to studs with 1 5/8" long Type S wafer head screws spaced 8" o.c. Vertical joints offset one stud cavity from gypsum wallboard joints. Horizontal joints offset not less than 12" from gypsum wallboard joints. <b>(NLB)</b></p> <p align="center"><b>PROPRIETARY GYPSUM BOARD</b></p> <p>United States Gypsum Company - 5/8" SHEETROCK® Brand FIRECODE® Core Gypsum Panels  - 1" SHEETROCK® Brand Gypsum Liner Panels</p>			

\*Contact the manufacturer for more detailed information on proprietary products.

<b>SHAFT WALLS</b>																																							
<b>GA FILE NO. WP 7082</b>	<b>PROPRIETARY*</b>	<b>2 HOUR FIRE</b>	<b>45 to 49 STC SOUND</b>																																				
<p style="text-align: center;"><b>GYPHUM BOARD, SLOTTED STEEL I STUDS</b></p> <p>One layer 1" x 24" proprietary type X gypsum panels inserted between 2 1/2" floor and ceiling runners with tab-flange section of 2 1/2" slotted steel I studs between panels.</p> <p>OPPOSITE SIDE: <b>Base</b> layer 1/2" proprietary type X gypsum wallboard or gypsum veneer base applied at right angles to studs with 1" Type S drywall screws 24" o.c. <b>Face</b> layer 1/2" proprietary type X gypsum wallboard or gypsum veneer base applied parallel to studs with 1 5/8" Type S drywall screws 12" o.c.</p> <p>Sound tested with 1" glass fiber insulation friction fit in stud space. <b>(NLB)</b></p> <p style="text-align: center;"><b>PROPRIETARY GYPHUM BOARD</b></p> <table border="0"> <tr> <td style="width: 30%;">CertainTeed Gypsum Inc.</td> <td style="width: 5%;">-</td> <td style="width: 30%;">1/2" ProRoc™ Type C Gypsum Panels</td> <td style="width: 35%;"></td> </tr> <tr> <td></td> <td>-</td> <td>1" ProRoc® Shaftliner Type X Gypsum Panels</td> <td></td> </tr> <tr> <td>PABCO Gypsum</td> <td>-</td> <td>1/2" FLAME CURB® Type XXX</td> <td></td> </tr> <tr> <td></td> <td>-</td> <td>1" PABCORE® Gypsum Liner Board</td> <td></td> </tr> </table>		CertainTeed Gypsum Inc.	-	1/2" ProRoc™ Type C Gypsum Panels			-	1" ProRoc® Shaftliner Type X Gypsum Panels		PABCO Gypsum	-	1/2" FLAME CURB® Type XXX			-	1" PABCORE® Gypsum Liner Board			<p>Thickness: 3 1/2"                  Approx. Weight: 9 psf                  Fire Test: WHI 495-0528, 7-12-83;                  WHI 495-0566, 11-1-83                  Sound Test: See WP 7083                  (WEAL 84-108, 3-16-84)</p>																				
CertainTeed Gypsum Inc.	-	1/2" ProRoc™ Type C Gypsum Panels																																					
	-	1" ProRoc® Shaftliner Type X Gypsum Panels																																					
PABCO Gypsum	-	1/2" FLAME CURB® Type XXX																																					
	-	1" PABCORE® Gypsum Liner Board																																					
<b>GA FILE NO. WP 7083</b>	<b>PROPRIETARY*</b>	<b>2 HOUR FIRE</b>	<b>45 to 49 STC SOUND</b>																																				
<p style="text-align: center;"><b>GYPHUM WALLBOARD, SLOTTED STEEL I STUDS</b></p> <p>One layer 1" x 24" proprietary type X gypsum panels inserted between 2 1/2" floor and ceiling runners with tab-flange section of 2 1/2" slotted steel I studs between panels. One layer 1/2" proprietary type X gypsum wallboard or gypsum veneer base applied parallel to each side with 1" Type S drywall screws 12" o.c.</p> <p>Sound tested with 1" glass fiber insulation friction fit in stud space. <b>(NLB)</b></p> <p style="text-align: center;"><b>PROPRIETARY GYPHUM BOARD</b></p> <table border="0"> <tr> <td style="width: 30%;">CertainTeed Gypsum Inc.</td> <td style="width: 5%;">-</td> <td style="width: 30%;">1/2" ProRoc® Type C Gypsum Panels</td> <td style="width: 35%;"></td> </tr> <tr> <td></td> <td>-</td> <td>1" ProRoc® Shaftliner Type X Gypsum Panels</td> <td></td> </tr> <tr> <td>PABCO Gypsum</td> <td>-</td> <td>1/2" FLAME CURB® Type XXX</td> <td></td> </tr> <tr> <td></td> <td>-</td> <td>1" PABCORE® Gypsum Liner Board</td> <td></td> </tr> </table>		CertainTeed Gypsum Inc.	-	1/2" ProRoc® Type C Gypsum Panels			-	1" ProRoc® Shaftliner Type X Gypsum Panels		PABCO Gypsum	-	1/2" FLAME CURB® Type XXX			-	1" PABCORE® Gypsum Liner Board			<p>Thickness: 3 1/2"                  Approx. Weight: 9 psf                  Fire Test: WHI 495-0569, 11-4-83;                  WHI 495-0570, 11-7-83                  Sound Test: WEAL 84-108, 3-16-84</p>																				
CertainTeed Gypsum Inc.	-	1/2" ProRoc® Type C Gypsum Panels																																					
	-	1" ProRoc® Shaftliner Type X Gypsum Panels																																					
PABCO Gypsum	-	1/2" FLAME CURB® Type XXX																																					
	-	1" PABCORE® Gypsum Liner Board																																					
<b>GA FILE NO. WP 7084</b>	<b>PROPRIETARY*</b>	<b>2 HOUR FIRE</b>	<b>45 to 49 STC SOUND</b>																																				
<p style="text-align: center;"><b>GYPHUM WALLBOARD, STEEL C-H OR C-T STUDS</b></p> <p>One layer 1" x 24" proprietary type X gypsum panels inserted between 2 1/2" floor and ceiling J runners with T section of 2 1/2" steel C-H or C-T studs between panels. One layer 1/2" proprietary type X gypsum wallboard applied parallel to each side with 1" Type S drywall screws 12" o.c.</p> <p>Sound tested with 1 7/8" glass fiber insulation friction fit in stud space. <b>(NLB)</b></p> <p style="text-align: center;"><b>PROPRIETARY GYPHUM BOARD</b></p> <table border="0"> <tr> <td style="width: 30%;">American Gypsum Company LLC</td> <td style="width: 5%;">-</td> <td style="width: 30%;">1/2" FireBloc® Type C Shaft Liner</td> <td style="width: 35%;"></td> </tr> <tr> <td>CertainTeed Gypsum Inc.</td> <td>-</td> <td>1/2" ProRoc® Type C Gypsum Panels</td> <td></td> </tr> <tr> <td></td> <td>-</td> <td>1" GlasRoc® Shaftliner Gypsum Panels</td> <td></td> </tr> <tr> <td>National Gypsum Company</td> <td>-</td> <td>1/2" Gold Bond® Brand FIRE-SHIELD C™ Gypsum Board</td> <td></td> </tr> <tr> <td></td> <td>-</td> <td>1" Gold Bond® Brand FIRE-SHIELD® Shaftliner</td> <td></td> </tr> <tr> <td>PABCO Gypsum</td> <td>-</td> <td>1/2" FLAME CURB® Super 'C'™</td> <td></td> </tr> <tr> <td></td> <td>-</td> <td>1" PABCORE® Gypsum Liner Board</td> <td></td> </tr> <tr> <td>Temple-Inland</td> <td>-</td> <td>1/2" TG-C</td> <td></td> </tr> <tr> <td></td> <td>-</td> <td>1" Silent Guard™ Gypsum Liner Board</td> <td></td> </tr> </table>		American Gypsum Company LLC	-	1/2" FireBloc® Type C Shaft Liner		CertainTeed Gypsum Inc.	-	1/2" ProRoc® Type C Gypsum Panels			-	1" GlasRoc® Shaftliner Gypsum Panels		National Gypsum Company	-	1/2" Gold Bond® Brand FIRE-SHIELD C™ Gypsum Board			-	1" Gold Bond® Brand FIRE-SHIELD® Shaftliner		PABCO Gypsum	-	1/2" FLAME CURB® Super 'C'™			-	1" PABCORE® Gypsum Liner Board		Temple-Inland	-	1/2" TG-C			-	1" Silent Guard™ Gypsum Liner Board			<p>Thickness: 3 1/2"                  Approx. Weight: 9 psf                  Fire Test: UL R7094, 93NK8151, 9-14-93,                  UL Design U429;                  UL R3660, 07NK22992, 2-18-08,                  UL Design U417                  Sound Test: RAL-TL93-182, 7-2-93                  WEAL 84-108, 3-16-84</p>
American Gypsum Company LLC	-	1/2" FireBloc® Type C Shaft Liner																																					
CertainTeed Gypsum Inc.	-	1/2" ProRoc® Type C Gypsum Panels																																					
	-	1" GlasRoc® Shaftliner Gypsum Panels																																					
National Gypsum Company	-	1/2" Gold Bond® Brand FIRE-SHIELD C™ Gypsum Board																																					
	-	1" Gold Bond® Brand FIRE-SHIELD® Shaftliner																																					
PABCO Gypsum	-	1/2" FLAME CURB® Super 'C'™																																					
	-	1" PABCORE® Gypsum Liner Board																																					
Temple-Inland	-	1/2" TG-C																																					
	-	1" Silent Guard™ Gypsum Liner Board																																					

\*Contact the manufacturer for more detailed information on proprietary products.

<b>SHAFT WALLS</b>																		
<b>GA FILE NO. WP 7095</b>	<b>PROPRIETARY*</b>	<b>2 HOUR FIRE</b>	<b>45 to 49 FSTC SOUND</b>															
<p style="text-align: center;"><b>GYPSUM WALLBOARD, STEEL C-H STUDS</b></p> <p>One layer 1" x 24" proprietary type X gypsum panels inserted between 2 1/2" floor and ceiling J runners with H section of 2 1/2" proprietary vented C-H steel studs between panels.</p> <p>OPPOSITE SIDE: <b>Base</b> layer 1/2" proprietary type X gypsum wallboard or gypsum veneer base applied parallel to studs with 1" Type S drywall screws 24" o.c. <b>Face</b> layer 1/2" proprietary type X gypsum wallboard or gypsum veneer base applied parallel to studs with 1 5/8" Type S drywall screws 12" o.c. Joints offset 24" o.c. from base layer joints.</p> <p>Sound tested with 1" mineral fiber insulation in cavity. <b>(NLB)</b></p> <p style="text-align: center;"><b>PROPRIETARY GYPSUM BOARD</b></p> <table border="0"> <tr> <td>American Gypsum Company LLC</td> <td>-</td> <td>1/2" FireBloc® Type C</td> </tr> <tr> <td>Lafarge North America Inc.</td> <td>-</td> <td>1/2" Firecheck® Type C</td> </tr> <tr> <td>Temple-Inland</td> <td>-</td> <td>1/2" TG-C</td> </tr> <tr> <td>United States Gypsum Company</td> <td>-</td> <td>1/2" SHEETROCK® Brand FIRECODE® C Core Gypsum Panels</td> </tr> <tr> <td></td> <td>-</td> <td>1" SHEETROCK® Brand Gypsum Liner Panels</td> </tr> </table>		American Gypsum Company LLC	-	1/2" FireBloc® Type C	Lafarge North America Inc.	-	1/2" Firecheck® Type C	Temple-Inland	-	1/2" TG-C	United States Gypsum Company	-	1/2" SHEETROCK® Brand FIRECODE® C Core Gypsum Panels		-	1" SHEETROCK® Brand Gypsum Liner Panels	 <p>Thickness: 3 1/2"                  Approx. Weight: 9 psf                  Fire Test: UL R1319, 82NK27438, 12-17-82, UL Design U438                  Field Sound Test: BBN 750706, 7-16-75</p>	
American Gypsum Company LLC	-	1/2" FireBloc® Type C																
Lafarge North America Inc.	-	1/2" Firecheck® Type C																
Temple-Inland	-	1/2" TG-C																
United States Gypsum Company	-	1/2" SHEETROCK® Brand FIRECODE® C Core Gypsum Panels																
	-	1" SHEETROCK® Brand Gypsum Liner Panels																
<b>GA FILE NO. WP 7096</b>	<b>PROPRIETARY*</b>	<b>2 HOUR FIRE</b>	<b>45 to 49 STC SOUND</b>															
<p style="text-align: center;"><b>GYPSUM WALLBOARD, STEEL C-T STUDS</b></p> <p>One layer 1" x 24" proprietary type X gypsum panels inserted between 2 1/2" floor and ceiling J runners with T section of 2 1/2" steel C-T studs between panels.</p> <p>OPPOSITE SIDE: <b>Base</b> layer 1/2" proprietary type X gypsum wallboard applied at right angles to studs with 1" Type S drywall screws 24" o.c. and 6" from floor and ceiling runners. <b>Face</b> layer 1/2" proprietary type X gypsum wallboard applied parallel to studs with 1 5/8" Type S drywall screws 12" o.c. and 3" from floor and ceiling runners. Joints offset 24" from base layer joints.</p> <p>Sound tested with 1" glass fiber insulation friction fit in stud space. <b>(NLB)</b></p> <p style="text-align: center;"><b>PROPRIETARY GYPSUM BOARD</b></p> <table border="0"> <tr> <td>CertainTeed Gypsum Inc.</td> <td>-</td> <td>1/2" ProRoc® Type C Gypsum Panels</td> </tr> <tr> <td></td> <td>-</td> <td>1" ProRoc® Shaftliner Type X Gypsum Panels</td> </tr> <tr> <td>Lafarge North America Inc.</td> <td>-</td> <td>1/2" Firecheck® Type C</td> </tr> <tr> <td></td> <td>-</td> <td>1" Firecheck® Shaftliner</td> </tr> </table>		CertainTeed Gypsum Inc.	-	1/2" ProRoc® Type C Gypsum Panels		-	1" ProRoc® Shaftliner Type X Gypsum Panels	Lafarge North America Inc.	-	1/2" Firecheck® Type C		-	1" Firecheck® Shaftliner	 <p>Thickness: 3 1/2"                  Approx. Weight: 9 psf                  Fire Test: WHI 495-1404/1405/1408/1409, 5-15-98, ITS Design LG/WA 120-01; UL R8701, 98NK33190, 7-12-99, UL Design U417                  Sound Test: RAL TL89-379, 11-7-89; WEAL 84-108, 3-16-84</p>				
CertainTeed Gypsum Inc.	-	1/2" ProRoc® Type C Gypsum Panels																
	-	1" ProRoc® Shaftliner Type X Gypsum Panels																
Lafarge North America Inc.	-	1/2" Firecheck® Type C																
	-	1" Firecheck® Shaftliner																
<b>GA FILE NO. WP 7097</b>	<b>PROPRIETARY*</b>	<b>2 HOUR FIRE</b>	<b>45 to 49 STC SOUND</b>															
<p style="text-align: center;"><b>GYPSUM WALLBOARD, STEEL C-T STUDS</b></p> <p>One layer 1" x 24" proprietary type X gypsum panels inserted between 2 1/2" floor and ceiling J runners with T section of 2 1/2" steel C-T studs between panels. One layer 1/2" proprietary type X gypsum wallboard applied parallel to each side with 1" Type S drywall screws 12" o.c.</p> <p>Joints staggered 24" on opposite sides. Sound tested with 1" glass fiber insulation friction fit in stud space. <b>(NLB)</b></p> <p style="text-align: center;"><b>PROPRIETARY GYPSUM BOARD</b></p> <table border="0"> <tr> <td>CertainTeed Gypsum Inc.</td> <td>-</td> <td>1/2" ProRoc® Type C Gypsum Panels</td> </tr> <tr> <td></td> <td>-</td> <td>1" ProRoc® Shaftliner Type X Gypsum Panels</td> </tr> <tr> <td>Lafarge North America Inc.</td> <td>-</td> <td>1/2" Firecheck® Type C</td> </tr> <tr> <td></td> <td>-</td> <td>1" Firecheck® Shaftliner</td> </tr> </table>		CertainTeed Gypsum Inc.	-	1/2" ProRoc® Type C Gypsum Panels		-	1" ProRoc® Shaftliner Type X Gypsum Panels	Lafarge North America Inc.	-	1/2" Firecheck® Type C		-	1" Firecheck® Shaftliner	 <p>Thickness: 3 1/2"                  Approx. Weight: 9 psf                  Fire Test: WHI 495-1406/1407/1410/1411, 5-22-98, ITS Design LG/WA 120-02; UL R8701, 98NK33190, 7-12-99, UL Design U417                  Sound Test: RAL TL89-380, 11-8-89; WEAL 84-108, 3-16-84</p>				
CertainTeed Gypsum Inc.	-	1/2" ProRoc® Type C Gypsum Panels																
	-	1" ProRoc® Shaftliner Type X Gypsum Panels																
Lafarge North America Inc.	-	1/2" Firecheck® Type C																
	-	1" Firecheck® Shaftliner																

*\*Contact the manufacturer for more detailed information on proprietary products.*

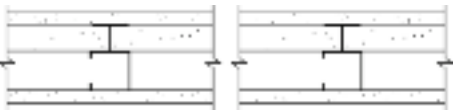
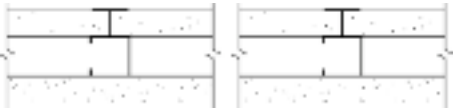
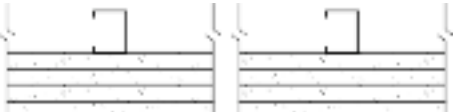

SHAFT WALLS			
GA FILE NO. WP 7118	PROPRIETARY*	2 HOUR FIRE	35 to 39 STC SOUND
<p align="center"><b>GYPSUM WALLBOARD, STEEL C-T STUDS</b></p>			
<p>One layer 1" x 24" proprietary type X gypsum panels inserted between 2 1/2" floor and ceiling J runners with T section of 2 1/2" steel C-T studs between panels. One layer 1/2" proprietary type X gypsum wallboard applied parallel to each side with 1" Type S drywall screws 12" o.c. and 6" from floor and ceiling runners.</p> <p>Joints staggered 24" on opposite sides. (NLB)</p>		<p>Thickness: 3 1/2"                      Approx. Weight: 9 psf                      Fire Test: WHI-495-1406/1407/1410/1411, 5-22-98;                      ITS Design LG/WA 120-02                      Sound Test: RAL TL08-174, 6-24-08</p>	
<p align="center"><b>PROPRIETARY GYPSUM BOARD</b></p>			
Lafarge North America Inc.	- 1/2" Firecheck® Type C - 1" Mold Defense® Shaftliner		
GA FILE NO. WP 7119	PROPRIETARY*	2 HOUR FIRE	35 to 39 STC SOUND
<p align="center"><b>GYPSUM WALLBOARD, STEEL C-T STUDS</b></p>			
<p>One layer 1" x 24" proprietary type X gypsum panels inserted between 2 1/2" floor and ceiling J runners with T section of 2 1/2" steel C-T studs between panels.</p>		<p>Thickness: 3 1/2"                      Approx. Weight: 9 psf                      Fire Test: WHI-495-1404/1405/1408/1409, 5-15-98;                      ITS Design LG/WA 120-01                      Sound Test: RAL TL08-168, 6-17-08</p>	
<p>OPPOSITE SIDE: <b>Base</b> layer 1/2" proprietary type X gypsum wallboard applied at right angles to studs with 1" Type S drywall screws 24" o.c. and 3" from floor and ceiling runners. <b>Face</b> layer 1/2" proprietary type X gypsum wallboard applied parallel to studs with 1 5/8" Type S drywall screws 12" o.c. and 6" from floor and ceiling runners. (NLB)</p>			
<p align="center"><b>PROPRIETARY GYPSUM BOARD</b></p>			
Lafarge North America Inc.	- 1/2" Firecheck® Type C - 1" Mold Defense® Shaftliner		
GA FILE NO. WP 7125	GENERIC	2 HOUR FIRE	35 to 39 STC SOUND
<p align="center"><b>GYPSUM WALLBOARD, STEEL STUDS</b></p>			
<p><b>Base</b> layer 5/8" type X gypsum wallboard or gypsum veneer base applied at right angles to ONE SIDE ONLY of 1 5/8" steel studs 24" o.c. with 1" Type S drywall screws 12" o.c. <b>Second</b> layer 5/8" type X gypsum wallboard or gypsum veneer base applied at right angles with two 1 5/8" Type S drywall screws per board. <b>Third</b> layer 5/8" type X gypsum wallboard or gypsum veneer base applied at right angles with two 2 5/8" Type S drywall screws per board and one 2 5/8" Type S drywall screws placed midway between studs at floor and ceiling runners. Steel strips 0.020" x 1 1/2" wide vertically applied over third layer at vertical joints and intermediate studs with 2 5/8" Type S drywall screws 12" o.c. <b>Fourth</b> layer 5/8" type X gypsum wallboard or gypsum veneer base applied at right angles to steel strips with 1" Type S drywall screws 8" o.c.</p>		<p>Thickness: 4 1/8"                      Limiting Height: 12'0"                      Approx. Weight: 9.5 psf                      Fire Test: GET, 4-13-70                      Sound Test: KG 634, 4-1-70</p>	
<p>Joints offset 24" between layers. (NLB)</p>			

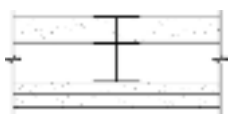
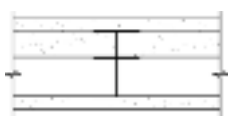

\*Contact the manufacturer for more detailed information on proprietary products.

<b>SHAFT WALLS</b>				
<b>GA FILE NO. WP 7210</b>	<b>GENERIC</b>	<b>2 HOUR FIRE</b>	<b>30 to 34 STC SOUND</b>	
<b>SOLID GYPSUM WALLBOARD</b>				
<p>One layer 5/8" type X gypsum wallboard or gypsum veneer base applied parallel to each side of vertically erected 1" gypsum board panels (solid or laminated) with laminating compound combed over the entire contact surface. Panel supported by steel runners at top and bottom and horizontal bracing angles of No. 22 gage galvanized steel 3/4" x 1 1/4" spaced 5'0" o.c. or less on shaft side. <b>(NLB)</b></p> <p>†Limiting height shown is based on interior partition exposure conditions. Shaft wall exposure conditions may require reduction of limiting height.</p>		 <p>Thickness: 2 1/4"                      Limiting Height: 11'0"†                      Approx. Weight: 9 psf                      Fire Test: UL R1319-58, 74, 12-29-64, UL Design U505                      Sound Test: Estimated</p>		
<b>GA FILE NO. WP 7254</b>	<b>PROPRIETARY*</b>	<b>2 HOUR FIRE</b>		
<b>GYPSUM PANEL PRODUCTS, STEEL I STUDS</b>				
<p>One layer 1" x 24" proprietary type X gypsum panels inserted between 2 1/2" floor and ceiling J runners with tab-flange section of 2 1/2" steel I studs between panels.</p> <p>OPPOSITE SIDE: <b>Base</b> layer 1/2" proprietary type X gypsum wallboard applied at right angles to studs with 1" Type S drywall screws 24" o.c. <b>Face</b> layer 1/2" proprietary type X gypsum wallboard applied parallel to studs with 1 5/8" Type S drywall screws 12" o.c. <b>(NLB)</b></p>		 <p>Thickness: 3 1/2"                      Approx. Weight: 9 psf                      Fire Test: UL R14196, 04NK4991, 2-10-04; UL R3660, 07NK22992, 2-18-07; UL Design V433 - System A</p>		
<b>PROPRIETARY GYPSUM PANEL PRODUCTS</b>				
American Gypsum Company LLC	-	1/2" FireBloc® Type C		
	-	1" Shaft Liner		
CertainTeed Gypsum Inc.	-	1/2" ProRoc® Type C Gypsum Panels		
	-	1" GlasRoc® Shaftliner Gypsum Panels		
Temple-Inland	-	1/2" TG-C		
	-	1" Silent Guard™ Gypsum Liner Board		
<b>GA FILE NO. WP 7255</b>	<b>PROPRIETARY*</b>	<b>2 HOUR FIRE</b>		
<b>GYPSUM PANEL PRODUCTS, STEEL I STUDS</b>				
<p>One layer 1" x 24" proprietary type X gypsum panels inserted between 2 1/2" floor and ceiling J runners with tab-flange section of 2 1/2" steel I studs between panels. One layer 1/2" proprietary type X gypsum wallboard applied parallel to each side with 1" Type S drywall screws 12" o.c. <b>(NLB)</b></p>		 <p>Thickness: 3 1/2"                      Approx. Weight: 9 psf                      Fire Test: UL R14196, 04NK4991, 2-10-04; UL R3660, 07NK22992, 2-18-08; UL Design V433 - System B</p>		
<b>PROPRIETARY GYPSUM PANEL PRODUCTS</b>				
American Gypsum Company LLC	-	1/2" FireBloc® Type C		
	-	1" Shaft Liner		
CertainTeed Gypsum Inc.	-	1/2" ProRoc® Type C Gypsum Panels		
	-	1" GlasRoc® Shaftliner Gypsum Panels		
Temple-Inland	-	1/2" TG-C		
	-	1" Silent Guard™ Gypsum Liner Board		

\*Contact the manufacturer for more detailed information on proprietary products.

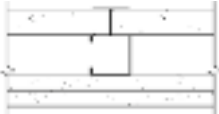

**SHAFT WALLS**

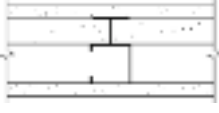
<p><b>GA FILE NO. WP 7256</b></p>	<p><b>PROPRIETARY*</b></p>	<p><b>2 HOUR FIRE</b></p>
<p><b>GYPSUM WALLBOARD, STEEL I, C-H, OR C-T STUDS</b></p>		
<p>One layer 1" x 24" proprietary type X gypsum panels inserted between 2 1/2" floor and ceiling runners with tab-flange section of 2 1/2" steel I, C-H, or C-T studs between panels.                  OPPOSITE SIDE: <b>Base</b> layer 5/8" proprietary type X gypsum wallboard or gypsum veneer base applied parallel or at right angles to studs with 1" Type S drywall screws 24" o.c.  <b>Face</b> layer 5/8" proprietary type X gypsum wallboard or gypsum veneer base applied at right angles to base layer with 1 5/8" Type S drywall screws 12" o.c. <b>(NLB)</b></p>		<p>Thickness: 3 3/4"                  Approx. Weight: 9 psf                  Fire Test: UL R14196, 05NK29331, 2-18-06, UL Design V455</p>
<p><b>PROPRIETARY GYPSUM BOARD</b>                  American Gypsum Company LLC - 5/8" FireBloc® Type X                  - 1" Shaft Liner</p>		
<p><b>GA FILE NO. WP 7257</b></p>	<p><b>PROPRIETARY*</b></p>	<p><b>2 HOUR FIRE</b></p>
<p><b>GYPSUM WALLBOARD, STEEL I, C-H, OR C-T STUDS</b></p>		
<p>One layer 1" x 24" proprietary type X gypsum panels inserted between 2 1/2" floor and ceiling runners with tab-flange section of 2 1/2" steel I, C-H, or C-T studs between panels. One layer 5/8" proprietary type X gypsum wallboard or gypsum veneer base applied parallel to each side with 1" Type S drywall screws 12" o.c. <b>(NLB)</b></p>		<p>Thickness: 3 3/4"                  Approx. Weight: 9 psf                  Fire Test: UL R14196, 05NK29331, 2-18-06, UL Design V455</p>
<p><b>PROPRIETARY GYPSUM BOARD</b>                  American Gypsum Company LLC - 5/8" FireBloc® Type X                  - 1" Shaft Liner</p>		
<p><b>GA FILE NO. WP 7258</b></p>	<p><b>PROPRIETARY*</b></p>	<p><b>2 HOUR FIRE</b></p>
<p><b>GYPSUM PANEL PRODUCTS, STEEL C-H OR C-T STUDS</b></p>		
<p>One layer 1" x 24" proprietary type X gypsum panels inserted between 2 1/2" floor and ceiling J runners with T section of 2 1/2" steel C-H or C-T studs between panels. <b>Face</b> layer 1/2" proprietary type X gypsum wallboard applied parallel to studs with vertical joints midway between studs and laminated to proprietary gypsum panels with 4" wide strips of taping compound at wallboard perimeter and vertical centerline. 1 1/2" Type G drywall screws 24" o.c. located 1 1/2" back from wallboard edges and at vertical centerline.                  OPPOSITE SIDE: <b>Base</b> layer 1/2" proprietary type X gypsum wallboard applied at right angles to studs with 1" Type S drywall screws 24" o.c. <b>(NLB)</b></p>		<p>Thickness: 4"                  Approx. Weight: 9 psf                  Fire Test: UL R6937, 08NK02787, 9-19-08, UL Design U429</p>
<p><b>PROPRIETARY GYPSUM PANEL PRODUCTS</b>                  Temple-Inland - 1/2" TG-C                  - 1" GreenGlass Gypsum Liner Panel</p>		

*\*Contact the manufacturer for more detailed information on proprietary products.*

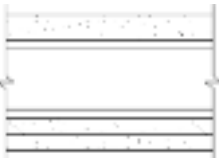
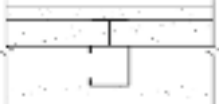
<b>SHAFT WALLS</b>									
<b>GA FILE NO. WP 7259</b>	<b>PROPRIETARY*</b>	<b>2 HOUR FIRE</b>							
<p style="text-align: center;"><b>GYPHUM PANEL PRODUCTS, STEEL C-H OR C-T STUDS</b></p> <p>One layer 1" x 24" proprietary type X gypsum panels inserted between 2 1/2" floor and ceiling J runners with T section of 2 1/2" steel C-H or C-T studs between panels.</p> <p>OPPOSITE SIDE: <b>Base</b> layer 1/2" proprietary type X gypsum wallboard applied at right angles to studs with 1" Type S drywall screws 24" o.c. <b>Face</b> layer 1/2" proprietary type X gypsum wallboard applied parallel to studs with 1 5/8" Type S drywall screws 12" o.c. (NLB)</p> <p style="text-align: center;"><b>PROPRIETARY GYPHUM PANEL PRODUCTS</b></p> <table border="0"> <tr> <td>Temple-Inland</td> <td>-</td> <td>1/2" TG-C</td> </tr> <tr> <td></td> <td>-</td> <td>1" GreenGlass Gypsum Liner Panel</td> </tr> </table>		Temple-Inland	-	1/2" TG-C		-	1" GreenGlass Gypsum Liner Panel		<p>Thickness: 3 1/2"                  Approx. Weight: 9 psf                  Fire Test: UL R6937, 08NK02787, 9-19-08, UL Design U428</p>
Temple-Inland	-	1/2" TG-C							
	-	1" GreenGlass Gypsum Liner Panel							
<b>GA FILE NO. WP 7260</b>	<b>PROPRIETARY*</b>	<b>2 HOUR FIRE</b>							
<p style="text-align: center;"><b>GYPHUM WALLBOARD, STEEL C-H STUDS</b></p> <p>One layer 1" x 24" proprietary type X gypsum liner panels applied parallel to 4" steel C-H studs spaced vertically 24" o.c. Steel C-H studs oriented horizontally and either supported by 2" x 2" 20 gage steel angles attached to vertical J track at each end of the wall or screw attached to the runners with 1/2" long panhead screws, one at each end on each side of the wall. Wall width is limited by the length of the gypsum liner panels.</p> <p>OPPOSITE SIDE: <b>Base</b> layer 5/8" proprietary type X gypsum wallboard applied parallel or at right angles to studs with 1" Type S or S-12 drywall screws 12" o.c. <b>Face</b> layer 5/8" proprietary type X gypsum wallboard applied parallel or at right angles to studs with 1" Type S or S-12 drywall screws 12" o.c. (NLB)</p> <p style="text-align: center;"><b>PROPRIETARY GYPHUM BOARD</b></p> <table border="0"> <tr> <td>United States Gypsum Company</td> <td>-</td> <td>5/8" SHEETROCK® Brand FIRECODE® Core Gypsum Panels</td> </tr> <tr> <td></td> <td></td> <td>1" SHEETROCK® Brand Gypsum Liner Panels</td> </tr> </table>		United States Gypsum Company	-	5/8" SHEETROCK® Brand FIRECODE® Core Gypsum Panels			1" SHEETROCK® Brand Gypsum Liner Panels		<p>Thickness: 5 1/4"                  Approx. Weight: 12 psf                  Fire Test: UL R1319, 04NK2667, 2-10-04; UL R1319, 04NK2664, 3-2-04; UL Design U437</p>
United States Gypsum Company	-	5/8" SHEETROCK® Brand FIRECODE® Core Gypsum Panels							
		1" SHEETROCK® Brand Gypsum Liner Panels							
<b>GA FILE NO. WP 7261</b>	<b>PROPRIETARY*</b>	<b>2 HOUR FIRE</b>							
<p style="text-align: center;"><b>GYPHUM WALLBOARD, STEEL C-H OR C-T STUDS</b></p> <p>One layer 1" x 24" proprietary type X gypsum panels inserted between 2 1/2" floor and ceiling J runners with T section of 2 1/2" steel C-H or C-T studs between panels. One layer 1/2" proprietary type X gypsum wallboard applied parallel to each side with 1" Type S drywall screws 12" o.c. (NLB)</p> <p style="text-align: center;"><b>PROPRIETARY GYPHUM PANEL PRODUCTS</b></p> <table border="0"> <tr> <td>Temple-Inland</td> <td>-</td> <td>1/2" TG-C</td> </tr> <tr> <td></td> <td>-</td> <td>1" GreenGlass Gypsum Liner Board</td> </tr> </table>		Temple-Inland	-	1/2" TG-C		-	1" GreenGlass Gypsum Liner Board		<p>Thickness: 3 1/2"                  Approx. Weight: 9 psf                  Fire Test: UL R6937, 08NK02787, 9-19-08, UL Design U429</p>
Temple-Inland	-	1/2" TG-C							
	-	1" GreenGlass Gypsum Liner Board							

\*Contact the manufacturer for more detailed information on proprietary products.

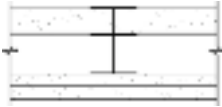
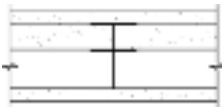
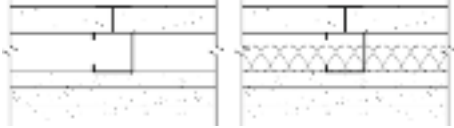
<b>SHAFT WALLS</b>			
<b>GA FILE NO. WP 7262</b>	<b>PROPRIETARY*</b>	<b>2 HOUR FIRE</b>	
<p style="text-align: center;"><b>GYPSUM PANEL PRODUCTS, STEEL I STUDS</b></p> <p>One layer 1" x 24" proprietary type X gypsum panels inserted between 2 1/2" floor and ceiling J runners with tab-flange section of 2 1/2" steel I studs between panels.</p> <p>OPPOSITE SIDE: <b>Base</b> layer 1/2" proprietary type X gypsum wallboard applied at right angles to studs with 1" Type S drywall screws 24" o.c. <b>Face</b> layer 1/2" proprietary type X gypsum wallboard applied parallel to studs with 1 5/8" Type S drywall screws 12" o.c. (NLB)</p>			<p>Thickness: 3 1/2"</p> <p>Approx. Weight: 9 psf</p> <p>Fire Test: UL R6937, 08NK02787, 9-19-08, UL Design V433 - System A</p>
<p style="text-align: center;"><b>PROPRIETARY GYPSUM PANEL PRODUCTS</b></p> <p>Temple-Inland - 1/2" TG-C - 1" GreenGlass Gypsum Liner Board</p>			
<b>GA FILE NO. WP 7263</b>	<b>PROPRIETARY*</b>	<b>2 HOUR FIRE</b>	
<p style="text-align: center;"><b>GYPSUM PANEL PRODUCTS, STEEL I STUDS</b></p> <p>One layer 1" x 24" proprietary type X gypsum panels inserted between 2 1/2" floor and ceiling J runners with tab-flange section of 2 1/2" steel I studs between panels. One layer 1/2" proprietary type X gypsum wallboard applied parallel to each side with 1" Type S drywall screws 12" o.c. (NLB)</p>			<p>Thickness: 3 1/2"</p> <p>Approx. Weight: 9 psf</p> <p>Fire Test: UL R6937, 08NK02787, 9-19-08, UL Design V433 - System B</p>
<p style="text-align: center;"><b>PROPRIETARY GYPSUM PANEL PRODUCTS</b></p> <p>Temple-Inland - 1/2" TG-C - 1" GreenGlass Gypsum Liner Board</p>			
<b>GA FILE NO. WP 7452</b>	<b>PROPRIETARY*</b>	<b>3 HOUR FIRE</b>	<b>45 to 49 STC SOUND</b>
<p style="text-align: center;"><b>GYPSUM PANEL PRODUCTS, METAL C-T STUDS</b></p> <p>One layer 1" x 24" proprietary type X gypsum panels inserted between 2 1/2" floor and ceiling J runners with T section of 2 1/2" steel C-T studs between panels.</p> <p>OPPOSITE SIDE: <b>Base</b> layer 5/8" proprietary type X gypsum wallboard applied at right angles to studs with 1" Type S drywall screws 24" o.c. <b>Second</b> layer 5/8" proprietary type X gypsum wallboard applied at right angles to studs with 1 5/8" Type S drywall screws 16" o.c. at studs and 1 1/2" Type G drywall screws 16" o.c. placed 2" back on either side of vertical joints. <b>Face</b> layer 5/8" proprietary type X gypsum wallboard applied parallel to studs with 2 1/4" Type S drywall screws 12" o.c. at studs and 1 1/2" Type G drywall screws 12" o.c. placed 2" back on either side of horizontal joints.</p> <p>Sound tested with 1" glass fiber insulation friction fit in stud space. (NLB)</p>			<p>Thickness: 4 3/8"</p> <p>Approx. Weight: 12 psf</p> <p>Fire Test: ITS, 8-30-01, ITS Design GP/WA 180-01</p> <p>Sound Test: See WP 7096 (RAL TL89-379, 11-7-89)</p>
<p style="text-align: center;"><b>PROPRIETARY GYPSUM PANEL PRODUCTS</b></p> <p>Georgia-Pacific Gypsum LLC - 5/8" ToughRock® Fireguard C™ - 1" DensGlass® Ultra Shaftliner™</p>			

*\*Contact the manufacturer for more detailed information on proprietary products.*

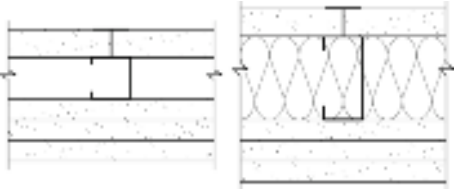
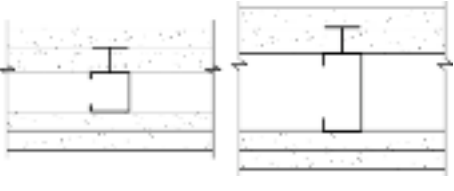

		<b>SHAFT WALLS</b>	
<b>GA FILE NO. WP 7453</b>	<b>PROPRIETARY*</b>	<b>3 HOUR FIRE</b>	<b>45 to 49 STC SOUND</b>
<b>GYPSUM WALLBOARD, FURRING CHANNELS, STEEL C-H STUDS</b>			
<p>One layer 1" x 24" proprietary type X gypsum liner panels inserted between 2 1/2" floor and ceiling runners with H section of 2 1/2" proprietary vented C-H steel studs between panels. When wall height exceeds liner panel length, liner panels are butted to extend to the full height of the wall. Horizontal joints need not be backed by steel framing.</p> <p>OPPOSITE SIDE: <b>First</b> layer 5/8" proprietary type X gypsum wallboard applied parallel or at right angles to studs with 1" Type S drywall screws spaced 24" o.c. when applied parallel to studs or 16" o.c. when applied at right angles to studs. <b>Second</b> layer 5/8" proprietary type X gypsum wallboard applied parallel or at right angles to studs with 1 5/8" Type S drywall screws spaced 24" o.c. when applied parallel to studs or 16" o.c. when applied at right angles to studs. <b>Face</b> layer 5/8" proprietary type X gypsum wallboard applied parallel or at right angles to studs with 2 1/4" Type S drywall screws spaced 16" o.c. when applied parallel to studs or 12" o.c. when applied at right angles to studs. Screws offset 6" from screws in layer below. Horizontal joints in adjacent layers offset not less than 12". Horizontal joints need not be backed by steel framing. Vertical joints centered over studs and offset 24" between adjacent layers.</p> <p>Sound tested using 4" C-H studs and 3" mineral fiber sound attenuation blankets in cavity. <b>(NLB)</b></p>		<p>Thickness: 4 3/8" (Fire) 5 7/8" (Sound)</p> <p>Approx. Weight: 13 psf</p> <p>Fire Test: UL R1319, 97NK33240, 4-29-96, UL Design U415 - System G</p> <p>Sound Test: RAL OT04-018, 9-4-04</p>	
<b>PROPRIETARY GYPSUM BOARD</b>			
<p>United States Gypsum Company - 5/8" SHEETROCK® Brand FIRECODE® C Core Gypsum Panels</p> <p>- 1" SHEETROCK® Brand Gypsum Liner Panels</p>			
<b>GA FILE NO. WP 7454</b>	<b>PROPRIETARY*</b>	<b>3 HOUR FIRE</b>	<b>45 to 49 FSTC SOUND</b>
<b>GYPSUM WALLBOARD, STEEL STUDS</b>			
<p>One layer 1" x 24" proprietary type X gypsum liner panels inserted between 4" floor and ceiling J runners with H section of 4" C-H steel studs between panels. When wall height exceeds liner panel length, liner panels are butted to extend to the full height of the wall. Horizontal joints need not be backed by steel framing. <b>Face</b> layer 5/8" proprietary type X gypsum wallboard applied parallel or at right angles to framing on gypsum liner panel side with 1" Type S drywall screws 16" o.c. when applied parallel to studs or 12" o.c. when applied at right angles to studs.</p> <p>OPPOSITE SIDE: <b>Base</b> layer 5/8" proprietary type X gypsum wallboard applied parallel or at right angles to studs with 1" Type S drywall screws 24" o.c. when applied parallel to studs or 16" o.c. when applied at right angles to studs. <b>Face</b> layer 5/8" proprietary type X gypsum wallboard applied parallel or at right angles to studs with 1 5/8" Type S drywall screws 16" o.c. when applied parallel to studs or 12" o.c. when applied at right angles to studs.</p> <p>Sound tested using 4" C-H studs. <b>(NLB)</b></p>		<p>Thickness: 4 3/8" (Fire) 5 7/8" (Sound)</p> <p>Approx. Weight: 12 psf</p> <p>Fire Test: UL R1319, 97NK33240, 4-26-96, UL Design U415 - System H</p> <p>Field Sound Test: USG 040902, 9-1-04</p>	
<b>PROPRIETARY GYPSUM BOARD</b>			
<p>United States Gypsum Company - 5/8" SHEETROCK® Brand FIRECODE® C Core Gypsum Panels</p> <p>- 1" SHEETROCK® Brand Gypsum Liner Panels</p>			

\*Contact the manufacturer for more detailed information on proprietary products.

**SHAFT WALLS**

<p><b>GA FILE NO. WP 7690</b></p>	<p><b>PROPRIETARY*</b></p>	<p><b>4 HOUR FIRE</b></p>
<p><b>GYPSUM WALLBOARD, FURRING CHANNELS, STEEL C-H STUDS</b></p>		
<p>One layer 1" x 24" proprietary type X gypsum liner panels inserted between 2 1/2" floor and ceiling runners with H section of 2 1/2" proprietary vented C-H steel studs between panels. When wall height exceeds liner panel length, liner panels are butted to extend to the full height of the wall. Horizontal joints need not be backed by steel framing.</p> <p>OPPOSITE SIDE: <b>First</b> layer 3/4" proprietary type X gypsum wallboard applied parallel or at right angles to studs with 1 1/4" Type S drywall screws 24" o.c. <b>Second</b> layer 3/4" proprietary type X gypsum wallboard applied parallel or at right angles to studs with 2 1/4" Type S drywall screws 12" o.c. Horizontal joints need not be backed by steel framing. When second layer is applied parallel to studs, vertical joints shall be centered over studs and offset not less than 24" from base layer joint; otherwise all joints shall be offset not less than 12". Rigid furring channels 24" o.c. applied at right angles to studs with 2" Type S-12 pan head screws. Screws alternate from top flange to bottom flange at each stud intersection. <b>Third</b> layer 3/4" proprietary type X gypsum wallboard applied at right angles to channels with 1 1/4" Type S drywall screws 12" o.c. <b>Face</b> layer 3/4" proprietary type X gypsum wallboard applied parallel or at right angles to channels with 2 1/4" Type S drywall screws 12" o.c. Joints offset 24" from third layer joints. When face layer is applied parallel to studs, vertical joints shall be centered over studs and offset not less than 24" from base layer joint; otherwise all joints shall be offset not less than 12" <b>(NLB)</b></p>		<p>Thickness: 6 3/8"                  Approx. Weight: 18 psf                  Fire Test: UL R1319, 97NK33240, 4-29-96, UL Design U415 - System I</p>
<p><b>PROPRIETARY GYPSUM BOARD</b>                  United States Gypsum Company - 3/4" SHEETROCK® Brand ULTRACODE® Core Gypsum Panels                  - 1" SHEETROCK® Brand Gypsum Liner Panels</p>		
<p><b>GA FILE NO. WP 7691</b></p>	<p><b>PROPRIETARY*</b></p>	<p><b>4 HOUR FIRE</b></p>
<p><b>GYPSUM WALLBOARD, FURRING CHANNELS, STEEL C-H, C-T, OR I STUDS</b></p>		
<p>One layer 1" x 24" proprietary type X gypsum panels inserted between 4" floor and ceiling runners with tab-flange section of 4" steel C-H, C-T, or I studs between panels.</p> <p>OPPOSITE SIDE: <b>First</b> layer 5/8" proprietary type X gypsum wallboard applied parallel to studs with 1 1/8" Type S drywall screws 12" o.c. <b>Second</b> layer 5/8" proprietary type X gypsum wallboard applied parallel to studs with 1 5/8" Type S drywall screws 12" o.c. and to the first layer with 1 1/2" Type G drywall screws 8" o.c. on both sides of horizontal joints. <b>Third</b> layer 5/8" proprietary type X gypsum wallboard applied parallel to studs with 2 1/4" Type S drywall screws 12" o.c. and to the second layer with 1 1/2" Type G drywall screws 12" o.c. vertically and centered between the studs, and spaced 8" o.c. on both sides of horizontal joints. Rigid furring channels spaced 16" o.c. applied at right angles to studs with 2 1/4" Type S drywall screws alternating top flange to bottom flange at each stud intersection. <b>Fourth</b> layer 5/8" proprietary type X gypsum wallboard applied at right angles to channels with 1 1/8" Type S drywall screws 12" o.c. in the field of the board and 8" o.c. on either side of horizontal joints centered on the channels. <b>Face</b> layer 5/8" proprietary type X gypsum wallboard applied at right angles to channels with 1 5/8" Type S drywall screws 12" o.c. in the field of the board and 8" o.c. on either side of horizontal joints centered on the channels, and to the fourth layer with 1 1/2" Type G drywall screws 16" o.c. along the vertical joints and centered between the furring channels. Vertical joints and horizontal butt joints offset 24" between layers. <b>(NLB)</b></p>		<p>Thickness: 8"                  Approx. Weight: 16.5 psf                  Fire Test: UL R3501, 05NK04286, 6-14-05; UL R3501, 05NK13523, 5-18-05; UL Design V451</p>
<p><b>PROPRIETARY GYPSUM BOARD</b>                  National Gypsum Company - 5/8" Gold Bond® Brand FIRE-SHIELD C™ Gypsum Board                  - 1" Gold Bond® Brand FIRE-SHIELD® Shaftliner</p>		

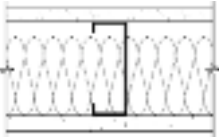
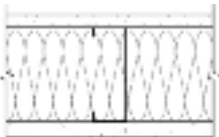
*\*Contact the manufacturer for more detailed information on proprietary products.*

<b>EXTERIOR WALLS</b>		
<b>GA FILE NO. WP 8002</b>	<b>PROPRIETARY*</b>	<b>1 HOUR FIRE</b>
<p style="text-align: center;"><b>GYPSUM WALLBOARD, MINERAL FIBER INSULATION, CEMENTITIOUS BACKER UNITS, STEEL STUDS</b></p> <p>EXTERIOR SIDE: One layer 1/2" proprietary cementitious backer units applied parallel to 3/8" 20 gage steel studs 16" o.c. with 1" corrosion resistant Type S-12 wafer head screws 8" o.c. A weather resistive barrier must be installed behind the cementitious backer unit. 3" mineral fiber friction fit in stud space.</p> <p>INTERIOR SIDE: One layer 5/8" proprietary type X gypsum wallboard or gypsum veneer base applied parallel to studs with 1" Type S-12 drywall screws 8" o.c. at vertical joints and floor and ceiling runners and 12" o.c. at intermediate studs. Joints taped. 3/32" of gypsum veneer plaster when gypsum veneer base is used. Lateral support for framing members as required. <b>(LOAD-BEARING)</b></p> <p style="text-align: center;"><b>PROPRIETARY GYPSUM BOARD</b></p> <p>United States Gypsum Company - 5/8" SHEETROCK® Brand FIRECODE® Core Gypsum Panels</p>		 <p>Thickness: 45/8"                      Approx. Weight: 7 psf                      Fire Test: UL R12262, 96NK4276, 5-1-96, UL Design U404</p>
<b>GA FILE NO. WP 8004</b>	<b>PROPRIETARY*</b>	<b>1 HOUR FIRE</b>
<p style="text-align: center;"><b>GYPSUM WALLBOARD, STEEL STUDS, MINERAL FIBER INSULATION, FIBER-CEMENT BOARD</b></p> <p>EXTERIOR SIDE: One layer 7/16" proprietary fiber-cement board applied parallel to 35/8" steel studs 16" o.c. with 1" No. 8-18 x 0.323" head diameter ribbed bugle head screws 6" o.c. 3 1/2" mineral fiber insulation batts or blankets, 3.0 pcf, in stud space.</p> <p>INTERIOR SIDE: One layer 5/8" proprietary type X gypsum wallboard applied parallel to studs with 1" Type S drywall screws 8" o.c. at edges and 12" o.c. at intermediate framing. <b>(NLB)</b></p> <p style="text-align: center;"><b>PROPRIETARY GYPSUM BOARD</b></p> <p>CertainTeed Gypsum Inc. - 5/8" ProRoc® Type X Gypsum Panels</p>		 <p>Thickness: 43/4"                      Approx. Weight: 7.5 psf                      Fire Test: OPL 11710-92783, 2-13-92</p>
<b>GA FILE NO. WP 8005</b>	<b>PROPRIETARY*</b>	<b>1 HOUR FIRE</b>
<p style="text-align: center;"><b>GLASS MAT GYPSUM SUBSTRATE, STEEL STUDS</b></p> <p>EXTERIOR SIDE: One layer 5/8" proprietary type X glass mat gypsum substrate (sheathing) applied parallel or at right angles to 35/8" steel studs 24" o.c. with 1" Type S corrosion resistant screws 8" o.c. at vertical studs and 12" o.c. at perimeter runners. Joints caulked with flexible, non-hardening building sealant or covered with weather exposed cladding or finish system.</p> <p>INTERIOR SIDE: One layer 5/8" proprietary type X glass mat gypsum substrate, glass mat water-resistant gypsum backing board, gypsum wallboard, water-resistant gypsum backing board, or gypsum veneer base applied parallel or at right angles to studs with 1" Type S drywall screws 8" o.c. at studs and 12" o.c. at floor and ceiling runners. <b>(NLB)</b></p> <p style="text-align: center;"><b>PROPRIETARY GYPSUM PANEL PRODUCT</b></p> <p>Georgia-Pacific Gypsum LLC - 5/8" DensGlass Gold® Fireguard®</p>		 <p>Thickness: 47/8"                      Approx. Weight: 6 psf                      Fire Test: CTC 2171-3996, 7-12-90</p>

\*Contact the manufacturer for more detailed information on proprietary products.

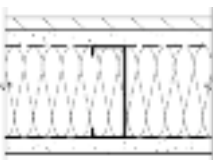
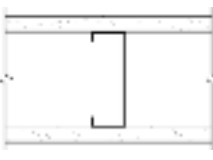
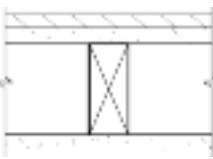
<b>EXTERIOR WALLS</b>			
<b>GA FILE NO. WP 8006</b>	<b>PROPRIETARY*</b>	<b>1 HOUR FIRE</b>	
<b>GYPSUM WALLBOARD, GLASS MAT GYPSUM SUBSTRATE, STEEL STUDS, MINERAL OR GLASS FIBER INSULATION</b>			
<p><b>EXTERIOR SIDE:</b> One layer 5/8" proprietary type X glass mat gypsum substrate (sheathing) applied parallel to 3 1/2" 20 gage steel studs 24" o.c. with 1" Type S-12, self-drilling, corrosion resistant, bugle head, drywall screws 12" o.c. Studs attached to both vertical legs of floor and ceiling runners either by welding or with 1/2" Type S-12 pan head screws. Mineral or glass fiber insulation friction fit into the stud space. Exterior cladding to be attached through glass mat gypsum panel to studs.</p> <p><b>INTERIOR SIDE:</b> One layer 5/8" proprietary type X gypsum board applied parallel to studs with 1" Type S-12 drywall screws 12" o.c.</p> <p><b>Bracing:</b> Lateral bracing spaced not over 40" o.c. shall be 1" by 18 gage steel straps attached to each side or channel bracing attached to each stud with a clip angle. For studs with holes or punch-outs in the web the "Q" factor shall be determined by means of stub column tests. Tested at 100 percent of design load. <b>(LOAD-BEARING)</b></p>			<p><b>FIRE SIDE</b></p>
		<p>Thickness: 4 3/4"                  Approx. Weight: 6 psf                  Fire Test: UL R3660/R15187, 01NK21103, 2-4-02; ULR6937, 07NK08079, 9-19-08; UL Design U425</p>	
<b>PROPRIETARY GYPSUM PANEL PRODUCTS</b>			
<p>CertainTeed Gypsum Inc. - 5/8" ProRoc® Type X Gypsum Panels                  - 5/8" GlasRoc® Sheathing Type X Gypsum Panels</p> <p>CertainTeed Gypsum Canada Inc. - 5/8" ProRoc® Type X Gypsum Panels</p> <p>Georgia-Pacific Gypsum LLC - 5/8" ToughRock® Fireguard®                  - 5/8" DensGlass Gold® Fireguard®</p> <p>National Gypsum Company - 5/8" e2XP® FIRE-SHIELD® Gypsum Sheathing                  - 5/8" Gold Bond® Brand FIRE-SHIELD® Gypsum Board</p> <p>Temple-Inland - 5/8" GreenGlass Type X                  - 5/8" Type X</p>			
<b>GA FILE NO. WP 8007</b>	<b>PROPRIETARY*</b>	<b>1 HOUR FIRE</b>	
<b>GYPSUM WALLBOARD, GLASS MAT GYPSUM SUBSTRATE, STEEL STUDS</b>			
<p><b>EXTERIOR SIDE:</b> One layer 5/8" proprietary type X glass mat gypsum substrate (sheathing) applied parallel or at right angles to 3 5/8" steel studs 24" o.c. with 1" Type S corrosion resistant screws 8" o.c. at vertical studs and 12" o.c. at perimeter runners. Joints caulked with flexible, non-hardening building sealant or covered with weather exposed cladding or finish system.</p> <p><b>INTERIOR SIDE:</b> One layer 5/8" proprietary type X glass mat gypsum substrate, glass mat water-resistant gypsum backing board, gypsum wallboard, water-resistant gypsum backing board, or gypsum veneer base applied parallel or at right angles to studs with 1" Type S drywall screws 8" o.c. at studs and 12" o.c. at floor and ceiling runners. <b>(NLB)</b></p>			<p><b>FIRE SIDE</b></p>
		<p>Thickness: 4 7/8"                  Approx. Weight: 6 psf                  Fire Test: UL R6937, 06NK17962, 2-17-07, UL Design U465</p>	
<b>PROPRIETARY GYPSUM PANEL PRODUCT</b>			
<p>Temple-Inland - 5/8" GreenGlass Type X                  - 5/8" Type X</p>			
<b>GA FILE NO. WP 8105</b>	<b>GENERIC</b>	<b>1 HOUR FIRE</b>	
<b>GYPSUM WALLBOARD, GYPSUM SHEATHING, WOOD STUDS</b>			
<p><b>EXTERIOR SIDE:</b> One layer 48" wide 5/8" type X gypsum sheathing applied parallel to 2 x 4 wood studs 24" o.c. with 1 3/4" galvanized roofing nails 4" o.c. at vertical joints and 7" o.c. at intermediate studs and top and bottom plates. Joints of gypsum sheathing may be left untreated. Exterior cladding to be attached through sheathing to studs.</p> <p><b>INTERIOR SIDE:</b> One layer 5/8" type X gypsum wallboard, water-resistant gypsum backing board, or gypsum veneer base applied parallel or at right angles to studs with 6d coated nails, 1 7/8" long, 0.0915" shank, 1/4" heads, 7" o.c. <b>(LOAD-BEARING)</b></p>			<p><b>FIRE SIDE</b></p>
		<p>Thickness: Varies                  Approx. Weight: 7 psf                  Fire Test: See WP 3510 (UL R3501-47, -48, 9-17-65, UL Design U309; UL R1319-129, 7-22-70, UL Design U314)</p>	

*\*Contact the manufacturer for more detailed information on proprietary products.*

**EXTERIOR WALLS**

**GA FILE NO. WP 8109**

**PROPRIETARY\***

**1 HOUR  
FIRE**

**GYPSUM PANEL PRODUCTS,  
FIBER-CEMENT SIDING, WOOD STUDS**

EXTERIOR SIDE: **Base** layer 5/8" proprietary type X gypsum sheathing or glass mat gypsum substrate applied parallel to 2 x 4 wood studs 16" o.c. with 1 3/4" galvanized roofing nails 4" o.c. at vertical joints and 7" o.c. at intermediate studs and top and bottom plates. Joints of gypsum sheathing may be left untreated. **Face** layer 1/4" proprietary fiber-cement siding fastened through sheathing to studs. 3 1/2" unfaced glass fiber friction fit in stud space.

INTERIOR SIDE: One layer 5/8" proprietary type X gypsum wallboard, glass mat gypsum substrate, water-resistant gypsum backing board, or gypsum veneer base applied parallel or at right angles to studs with 6d coated nails, 1 7/8" long, 0.0915" shank, 1/4" heads, 7" o.c. (**LOAD BEARING**)

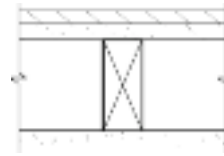

Thickness: 5 1/8"  
Approx. Weight: 9 psf  
Fire Test: See WP 3510  
(UL R3501-47, -48, 9-17-65,  
UL Design U309;  
UL R-1319-129, 7-22-70,  
UL Design U314)

**PROPRIETARY GYPSUM PANEL PRODUCTS**

- |                             |   |                                       |
|-----------------------------|---|---------------------------------------|
| American Gypsum Company LLC | - | 5/8" FireBloc® Type X                 |
|                             | - | 5/8" Exterior Sheathing Type X        |
| CertainTeed Gypsum Inc.     | - | 5/8" ProRoc® Type X Gypsum Panels     |
|                             | - | 5/8" GlasRoc® Sheathing Type X        |
|                             |   | Gypsum Panels                         |
| Georgia-Pacific Gypsum LLC  | - | 5/8" DensArmor Plus® Fireguard®       |
|                             | - | Interior Guard                        |
|                             | - | 5/8" DensGlass Gold® Fireguard®       |
| Lafarge North America Inc.  | - | 5/8" Firecheck® Type X                |
|                             | - | 5/8" Firecheck® Sheathing Type X      |
| National Gypsum Company     | - | 5/8" Gold Bond® Brand FIRE-SHIELD®    |
|                             | - | Gypsum Board                          |
|                             | - | 5/8" Gold Bond® Brand FIRE-SHIELD®    |
|                             | - | Gypsum Sheathing                      |
| PABCO Gypsum                | - | 5/8" FLAME CURB® Type X               |
|                             | - | 5/8" Exterior Gypsum Sheathing Type X |
| Temple-Inland               | - | 5/8" Type X                           |
|                             | - | 5/8" Type X Sheathing                 |

**GA FILE NO. WP 8111**

**PROPRIETARY\***

**1 HOUR  
FIRE**

**GYPSUM WALLBOARD, GLASS MAT GYPSUM SUBSTRATE,  
RESILIENT CHANNELS, MINERAL OR GLASS FIBER  
INSULATION, WOOD STUDS**

EXTERIOR SIDE: One layer 5/8" proprietary type X glass mat gypsum substrate (sheathing) applied parallel or at right angles to 2 x 4 wood studs 16" o.c. with 1 7/8" galvanized nails 7" o.c. 3" mineral or glass fiber insulation in stud space. Exterior cladding to be attached through glass mat gypsum substrate to studs.

INTERIOR SIDE: Resilient channels 24" o.c. attached at right angles to studs with one 1 1/4" Type W drywall screw at each stud. One layer 5/8" proprietary type X gypsum board applied at right angles to channels with Type S or S-12 drywall screws 8" o.c.

Joints staggered on opposite sides. (**LOAD-BEARING**)

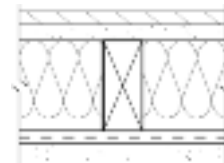

Thickness: 5 3/8"  
Approx. Weight: 7 psf  
Fire Test: UL R3660/R15187,  
01NK21103, 2-4-02;  
UL R3501, 07NK17992,  
12-12-07;  
UL R6937, 06NK17692,  
9-19-08;  
UL Design U305

**PROPRIETARY GYPSUM PANEL PRODUCTS**

- |                                |   |                                    |
|--------------------------------|---|------------------------------------|
| CertainTeed Gypsum Inc.        | - | 5/8" ProRoc® Type X Gypsum Panels  |
|                                | - | 5/8" GlasRoc® Sheathing Type X     |
|                                |   | Gypsum Panels                      |
| CertainTeed Gypsum Canada Inc. | - | 5/8" ProRoc® Type X Gypsum Panels  |
| National Gypsum Company        | - | 5/8" e2XP® FIRE-SHIELD®            |
|                                | - | Gypsum Sheathing                   |
|                                | - | 5/8" Gold Bond® Brand FIRE-SHIELD® |
|                                | - | Gypsum Board                       |
| Temple-Inland                  | - | 5/8" GreenGlass Type X             |
|                                | - | 5/8" Type X                        |

\*Contact the manufacturer for more detailed information on proprietary products.



EXTERIOR WALLS																																
GA FILE NO. WP 8122	GENERIC	1 HOUR FIRE																														
<p align="center"><b>GYPSUM WALLBOARD, STEEL STUDS, POLYMER MODIFIED EXTERIOR INSULATION &amp; FINISH SYSTEM</b></p>			<p>Thickness: 6" - 7" Varies                      Approx. Weight: 7 psf                      Fire Test: SWRI 01-4409-003, 6-5-92</p>																													
<p>EXTERIOR SIDE: One layer 5/8" type X gypsum sheathing applied parallel to 3 5/8" 18 gage steel studs 16" o.c. with #6x1 1/4" self-drilling, corrosion resistant, bugle head, drywall screws 8" o.c. at edges and ends and 12" o.c. at intermediate studs. Polymer modified exterior insulation &amp; finish system applied over sheathing. 2" maximum foam plastic thickness.</p> <p>INTERIOR SIDE: One layer 5/8" type X gypsum wallboard applied parallel to studs with #6x1 1/4" self-drilling, bugle head, drywall screws 8" o.c. at edges and ends and 12" o.c. at intermediate studs. (NLB)</p>																																
GA FILE NO. WP 8123	GENERIC	1 HOUR FIRE																														
<p align="center"><b>GYPSUM WALLBOARD, STEEL STUDS, POLYMER BASED EXTERIOR INSULATION &amp; FINISH SYSTEM</b></p>			<p>Thickness: 5 3/4" - 9" Varies                      Approx. Weight: 7 psf                      Fire Test: SWRI 01-4409-001(c), 1-24-92</p>																													
<p>EXTERIOR SIDE: One layer 5/8" type X gypsum sheathing applied parallel to 3 5/8" 18 gage steel studs 24" o.c. with #6x1 1/4" self-drilling, corrosion resistant, bugle head, drywall screws 8" o.c. at edges and ends and 12" o.c. at intermediate studs. Polymer based exterior insulation &amp; finish system applied over sheathing. 4" maximum foam plastic thickness.</p> <p>INTERIOR SIDE: One layer 5/8" type X gypsum wallboard applied parallel to studs with #6x1 1/4" self-drilling, bugle head, drywall screws 8" o.c. at edges and ends and 12" o.c. at intermediate studs. (NLB)</p>																																
GA FILE NO. WP 8126	PROPRIETARY*	1 HOUR FIRE																														
<p align="center"><b>GYPSUM PANEL PRODUCTS, FOAM PLASTIC BOARDS, WOOD STUDS, EXTERIOR CLADDING</b></p>			<p>Thickness: Varies                      Approx. Weight: 6 psf                      Fire Test: UL R2637, 94NK19449, 6-28-96, UL Design U354</p>																													
<p>EXTERIOR SIDE: <b>Base</b> layer 5/8" proprietary type X gypsum sheathing or glass mat gypsum substrate applied parallel or at right angles to 2 x 4 wood studs 16" o.c. with 6d cement-coated or common nails or 1 7/8" Type W drywall screws 7" o.c. <b>Second</b> layer maximum 1 1/2" proprietary faced polyisocyanurate foam plastic sheathing applied parallel to studs with 3" galvanized roofing nails 8" o.c. at perimeter and 12" o.c. at intermediate studs. <b>Face</b> layer exterior siding, fiber-cement siding, masonry veneer, stucco, or exterior insulation and finish system (EIFS).</p> <p>INTERIOR SIDE: 5/8" proprietary type X gypsum wallboard applied at right angles to studs with 6d cement-coated or common nails or 1 7/8" Type W drywall screws 7" o.c. Unfaced 3 1/2" glass fiber, 0.72 pcf, friction fit in stud space. (LOAD-BEARING)</p>																																
<p align="center"><b>PROPRIETARY GYPSUM PANEL PRODUCTS</b></p> <table border="0"> <tr> <td>American Gypsum Company LLC</td> <td>-</td> <td>5/8" FireBloc® Type X</td> </tr> <tr> <td></td> <td>-</td> <td>5/8" Exterior Sheathing Type X</td> </tr> <tr> <td>CertainTeed Gypsum Inc.</td> <td>-</td> <td>5/8" GlasRoc® Sheathing Type X Gypsum Panels</td> </tr> <tr> <td></td> <td>-</td> <td>5/8" ProRoc® Type X Gypsum Panels</td> </tr> <tr> <td>Lafarge North America Inc.</td> <td>-</td> <td>5/8" Firecheck® Sheathing Type X</td> </tr> <tr> <td></td> <td>-</td> <td>5/8" Firecheck® Type X</td> </tr> <tr> <td>National Gypsum Company</td> <td>-</td> <td>5/8" Gold Bond® Brand FIRE-SHIELD® Gypsum Sheathing</td> </tr> <tr> <td></td> <td>-</td> <td>5/8" Gold Bond® Brand FIRE-SHIELD® Gypsum Board</td> </tr> <tr> <td>Temple-Inland</td> <td>-</td> <td>5/8" Type X</td> </tr> <tr> <td></td> <td>-</td> <td>5/8" GreenGlass Type X</td> </tr> </table>		American Gypsum Company LLC	-	5/8" FireBloc® Type X		-	5/8" Exterior Sheathing Type X	CertainTeed Gypsum Inc.	-	5/8" GlasRoc® Sheathing Type X Gypsum Panels		-	5/8" ProRoc® Type X Gypsum Panels	Lafarge North America Inc.	-	5/8" Firecheck® Sheathing Type X		-	5/8" Firecheck® Type X	National Gypsum Company	-	5/8" Gold Bond® Brand FIRE-SHIELD® Gypsum Sheathing		-	5/8" Gold Bond® Brand FIRE-SHIELD® Gypsum Board	Temple-Inland	-	5/8" Type X		-	5/8" GreenGlass Type X	
American Gypsum Company LLC	-	5/8" FireBloc® Type X																														
	-	5/8" Exterior Sheathing Type X																														
CertainTeed Gypsum Inc.	-	5/8" GlasRoc® Sheathing Type X Gypsum Panels																														
	-	5/8" ProRoc® Type X Gypsum Panels																														
Lafarge North America Inc.	-	5/8" Firecheck® Sheathing Type X																														
	-	5/8" Firecheck® Type X																														
National Gypsum Company	-	5/8" Gold Bond® Brand FIRE-SHIELD® Gypsum Sheathing																														
	-	5/8" Gold Bond® Brand FIRE-SHIELD® Gypsum Board																														
Temple-Inland	-	5/8" Type X																														
	-	5/8" GreenGlass Type X																														

\*Contact the manufacturer for more detailed information on proprietary products.

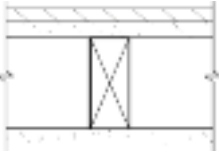
<b>EXTERIOR WALLS</b>																																		
<b>GA FILE NO. WP 8130</b>	<b>PROPRIETARY*</b>	<b>1 HOUR FIRE</b>																																
<b>GYPSUM WALLBOARD, GLASS MAT GYPSUM SUBSTRATE, WOOD STUDS</b>			<p>Thickness: 4<sup>3</sup>/<sub>4</sub>"                      Approx. Weight: 7.5 psf                      Fire Test: WHI-495-0702, 8-7-85;                      WHI-495-0703, 8-8-85;                      UL R2717, 89NK3419, 8-29-89;                      UL R3501, 07NK17992, 12-12-07;                      UL R6937, 06NK17692, 9-19-08;                      UL R15187, 02NK31412, 7-17-02;                      UL Designs U337 &amp; U305</p>																															
<p>EXTERIOR SIDE: One layer 5/8" proprietary type X glass mat gypsum substrate (sheathing) applied parallel or at right angles to 2 x 4 wood studs 16" o.c. with galvanized roofing nails, 1<sup>3</sup>/<sub>4</sub>" long, 0.128" shank, 7/16" head, 7" o.c. Exterior surface covered with weather exposed cladding or finish system.</p> <p>INTERIOR SIDE: One layer 5/8" proprietary type X glass mat gypsum substrate, glass mat water-resistant gypsum backing board, gypsum wallboard, water-resistant gypsum backing board, or gypsum veneer base applied parallel or at right angles to studs with 6d coated nails, 1<sup>7</sup>/<sub>8</sub>" long, 0.0915" shank, 1/4" heads, 7" o.c.</p> <p>Joints staggered on opposite sides. <b>(LOAD-BEARING)</b></p> <p style="text-align: center;"><b>PROPRIETARY GYPSUM PANEL PRODUCTS</b></p> <table style="width: 100%; border: none;"> <tr> <td style="width: 30%;">American Gypsum Company LLC</td> <td style="width: 10%; text-align: center;">-</td> <td style="width: 50%;">5/8" FireBloc® Type X</td> </tr> <tr> <td>CertainTeed Gypsum Inc.</td> <td style="text-align: center;">-</td> <td>5/8" ProRoc® Type X Gypsum Panels</td> </tr> <tr> <td></td> <td style="text-align: center;">-</td> <td>5/8" GlasRoc® Sheathing Type X Gypsum Panels</td> </tr> <tr> <td>Georgia-Pacific Gypsum LLC</td> <td style="text-align: center;">-</td> <td>5/8" DensGlass Gold® Fireguard®</td> </tr> <tr> <td></td> <td style="text-align: center;">-</td> <td>5/8" DensArmor Plus® Fireguard® Interior Guard</td> </tr> <tr> <td>Lafarge North America Inc.</td> <td style="text-align: center;">-</td> <td>5/8" Firecheck® Type X</td> </tr> <tr> <td>Temple-Inland</td> <td style="text-align: center;">-</td> <td>5/8" Type X</td> </tr> <tr> <td>National Gypsum Company</td> <td style="text-align: center;">-</td> <td>5/8" e2XP® FIRE-SHIELD® Gypsum Sheathing</td> </tr> <tr> <td></td> <td style="text-align: center;">-</td> <td>5/8" Gold Bond® Brand FIRE-SHIELD® Gypsum Board</td> </tr> <tr> <td>Temple-Inland</td> <td style="text-align: center;">-</td> <td>5/8" GreenGlass Type X</td> </tr> <tr> <td></td> <td style="text-align: center;">-</td> <td>5/8" Type X</td> </tr> </table>				American Gypsum Company LLC	-	5/8" FireBloc® Type X	CertainTeed Gypsum Inc.	-	5/8" ProRoc® Type X Gypsum Panels		-	5/8" GlasRoc® Sheathing Type X Gypsum Panels	Georgia-Pacific Gypsum LLC	-	5/8" DensGlass Gold® Fireguard®		-	5/8" DensArmor Plus® Fireguard® Interior Guard	Lafarge North America Inc.	-	5/8" Firecheck® Type X	Temple-Inland	-	5/8" Type X	National Gypsum Company	-	5/8" e2XP® FIRE-SHIELD® Gypsum Sheathing		-	5/8" Gold Bond® Brand FIRE-SHIELD® Gypsum Board	Temple-Inland	-	5/8" GreenGlass Type X	
American Gypsum Company LLC	-	5/8" FireBloc® Type X																																
CertainTeed Gypsum Inc.	-	5/8" ProRoc® Type X Gypsum Panels																																
	-	5/8" GlasRoc® Sheathing Type X Gypsum Panels																																
Georgia-Pacific Gypsum LLC	-	5/8" DensGlass Gold® Fireguard®																																
	-	5/8" DensArmor Plus® Fireguard® Interior Guard																																
Lafarge North America Inc.	-	5/8" Firecheck® Type X																																
Temple-Inland	-	5/8" Type X																																
National Gypsum Company	-	5/8" e2XP® FIRE-SHIELD® Gypsum Sheathing																																
	-	5/8" Gold Bond® Brand FIRE-SHIELD® Gypsum Board																																
Temple-Inland	-	5/8" GreenGlass Type X																																
	-	5/8" Type X																																

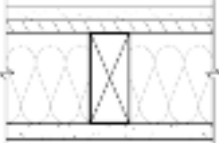
<b>GA FILE NO. WP 8131</b>	<b>PROPRIETARY*</b>	<b>1 HOUR FIRE</b>		
<b>GYPSUM WALLBOARD, WOOD STUDS, MINERAL FIBER INSULATION, WOOD STRUCTURAL PANELS, CEMENTITIOUS BACKER UNITS</b>			<p>Thickness: 6<sup>1</sup>/<sub>2</sub>"                      Approx. Weight: 14 psf                      Fire Test: UL R1319, 97NK14997, 4-25-97,                      UL Design U303</p>	
<p>EXTERIOR SIDE: <b>Base</b> layer 1<sup>5</sup>/<sub>32</sub>" wood structural panels applied parallel to 2 x 4 wood studs 16" o.c. with 10d galvanized nails 6" o.c. at edges and at top and bottom plates and 12" o.c. at intermediate studs. Weather resistive barrier applied over panels. <b>Face</b> layer 1/2" proprietary cementitious backer units applied parallel or at right angles to studs with 1<sup>5</sup>/<sub>8</sub>" long corrosion resistant screws 8" o.c.</p> <p>INTERIOR SIDE: One layer 5/8" proprietary type X gypsum wallboard applied parallel or at right angles to studs with either 6d cement coated nails, 1<sup>7</sup>/<sub>8</sub>" long 7" o.c. or 1<sup>7</sup>/<sub>8</sub>" long Type S or Type W drywall screws 8" o.c. 3" mineral fiber insulation, 3.0 pcf, friction fit in stud space. <b>(LOAD-BEARING)</b></p> <p style="text-align: center;"><b>PROPRIETARY GYPSUM BOARD</b></p> <table style="width: 100%; border: none;"> <tr> <td style="width: 30%;">United States Gypsum Company</td> <td style="width: 10%; text-align: center;">-</td> <td style="width: 60%;">5/8" SHEETROCK® Brand FIRECODE® Core Gypsum Panels</td> </tr> </table>				United States Gypsum Company
United States Gypsum Company	-	5/8" SHEETROCK® Brand FIRECODE® Core Gypsum Panels		

\*Contact the manufacturer for more detailed information on proprietary products.

**EXTERIOR WALLS**

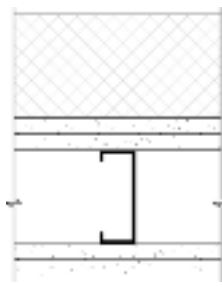
<p><b>GA FILE NO. WP 8202</b></p>	<p><b>GENERIC</b></p>	<p><b>2 HOUR FIRE</b></p>	
<p><b>GYPSUM WALLBOARD, STEEL STUDS, POLYMER BASED EXTERIOR INSULATION &amp; FINISH SYSTEM</b></p>			
<p>EXTERIOR SIDE: <b>Base</b> layer 5/8" type X gypsum sheathing applied parallel to 35/8" 18 gage steel studs 16" o.c. with #6x1 1/4" self-drilling, corrosion resistant, bugle head, drywall screws 24" o.c. <b>Face</b> layer 5/8" type X gypsum sheathing applied parallel to studs with #6x17/8" self-drilling, corrosion resistant, bugle head, drywall screws 8" o.c. at edges and ends and 12" o.c. at intermediate studs. Polymer based exterior insulation &amp; finish system applied over sheathing. 4" maximum foam plastic thickness.</p> <p>INTERIOR SIDE: <b>Base</b> layer 5/8" type X gypsum wallboard applied parallel to studs with #6x1 1/4" self-drilling, bugle head, drywall screws 24" o.c. <b>Face</b> layer 5/8" type X gypsum wallboard applied parallel to studs with #6x17/8" self-drilling, bugle head, drywall screws 8" o.c. at edges and ends and 12" o.c. at intermediate studs.</p> <p>Joints staggered each layer and side. <b>(NLB)</b></p>			
		<p>Thickness: 7" - 10 1/4" Varies                  Approx. Weight: 12 psf                  Fire Test: SWRI 01-4409-001(e), 4-27-92</p>	

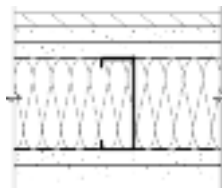
<p><b>GA FILE NO. WP 8203</b></p>	<p><b>PROPRIETARY*</b></p>	<p><b>2 HOUR FIRE</b></p>	
<p><b>GYPSUM WALLBOARD, GLASS MAT GYPSUM SUBSTRATE, STEEL STUDS, MINERAL OR GLASS FIBER INSULATION</b></p>			
<p>EXTERIOR SIDE: <b>Base</b> layer 5/8" proprietary type X glass mat gypsum substrate (sheathing) applied parallel to 3 1/2" 20 gage steel studs 24" o.c. with 1" Type S-12, self-drilling, corrosion resistant, bugle head, drywall screws 12" o.c. Studs attached to each side of floor and ceiling runners by welding or with 1/2" Type S-12 pan head screws. <b>Face</b> layer 5/8" proprietary type X glass mat gypsum substrate (sheathing) applied parallel to studs with 1 5/8" Type S-12, self-drilling, corrosion resistant, bugle head, drywall screws 12" o.c. Mineral or glass fiber insulation friction fit into the stud space. Exterior cladding to be attached through glass mat gypsum panel to studs.</p> <p>INTERIOR SIDE: <b>Base</b> layer 5/8" proprietary type X gypsum board applied parallel to studs with 1" Type S-12 drywall screws 12" o.c. <b>Face</b> layer 5/8" proprietary type X gypsum board applied parallel to studs with 1 5/8" Type S-12 drywall screws 12" o.c.</p> <p>Joints staggered 24" each layer and side.</p> <p><b>Bracing:</b> Lateral bracing spaced not over 40" o.c. shall be 1" by 18 gage steel straps attached to each side or channel bracing attached to each stud with a clip angle. For studs with holes or punch-outs in the web the "Q" factor shall be determined by means of stub column tests. Tested at 80 percent of design load. <b>(LOAD-BEARING)</b></p>			
		<p>FIRE SIDE</p>	<p>Thickness: 6"                  Approx. Weight: 10 psf                  Fire Test: UL R3660/R15187, 01NK21103, 2-4-02, UL Design U425</p>
<p><b>PROPRIETARY GYPSUM PANEL PRODUCTS</b></p>			
<p>CertainTeed Gypsum Inc.</p>	<ul style="list-style-type: none"> <li>- 5/8" ProRoc® Type X Gypsum Panels</li> <li>- 5/8" GlasRoc® Sheathing Type X Gypsum Panels</li> </ul>		
<p>CertainTeed Gypsum Canada Inc.</p>	<ul style="list-style-type: none"> <li>- 5/8" ProRoc® Type X Gypsum Panels</li> </ul>		
<p>Georgia-Pacific Gypsum LLC</p>	<ul style="list-style-type: none"> <li>- 5/8" ToughRock® Fireguard®</li> <li>- 5/8" DensGlass Gold® Fireguard®</li> </ul>		
<p>National Gypsum Company</p>	<ul style="list-style-type: none"> <li>- 5/8" e2XP FIRE-SHIELD® Gypsum Sheathing</li> <li>- 5/8" Gold Bond® Brand FIRE-SHIELD® Gypsum Board</li> </ul>		

*\*Contact the manufacturer for more detailed information on proprietary products.*

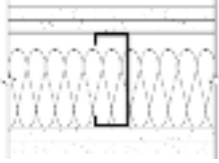
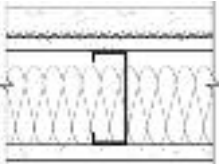
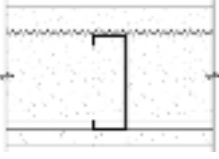
<b>EXTERIOR WALLS</b>																								
<b>GA FILE NO. WP 8205</b>	<b>PROPRIETARY*</b>	<b>2 HOUR FIRE</b>																						
<p><b>GYPSUM WALLBOARD, MINERAL FIBER INSULATION, CEMENTITIOUS BACKER UNIT, METAL STUD</b></p> <p>EXTERIOR SIDE: <b>Base</b> layer 5/8" proprietary type X gypsum sheathing applied parallel to 35/8" 20 gage steel studs 16" o.c. with 1" Type S-12 drywall screws 24" o.c. <b>Face</b> layer 5/8" proprietary type X gypsum sheathing applied parallel to framing with 15/8" Type S-12 drywall screws 12" o.c. or 1/2" proprietary cementitious backer unit applied parallel or at right angles to framing with 15/8" Type S-12 wafer head screws 8" o.c.</p> <p>INTERIOR SIDE: <b>Base</b> layer 1/2" proprietary type X gypsum wallboard or gypsum veneer base applied parallel to framing with 1" Type S-12 drywall screws 24" o.c. <b>Face</b> layer 1/2" proprietary cementitious backer unit applied parallel or at right angles to framing with 15/8" Type S-12 wafer head screws 8" o.c. Joints finished. 3" mineral fiber friction fit in stud space.</p> <p>Joints staggered each layer and side. Weather resistive barrier must be installed behind the cementitious backer unit on the exterior side. <b>(NLB)</b></p> <p style="text-align: center;"><b>PROPRIETARY GYPSUM BOARD</b></p> <table style="width: 100%; border: none;"> <tr> <td style="width: 30%;">American Gypsum Company LLC</td> <td style="width: 30%;">-</td> <td style="width: 30%;">1/2" FireBloc® Type C</td> </tr> <tr> <td>CertainTeed Gypsum Inc.</td> <td>-</td> <td>1/2" ProRoc® Type C Gypsum Panels</td> </tr> <tr> <td>Lafarge North America Inc.</td> <td>-</td> <td>1/2" Firecheck® Type C</td> </tr> <tr> <td>Temple-Inland</td> <td>-</td> <td>5/8" Sheathing Type TG-C</td> </tr> <tr> <td></td> <td>-</td> <td>1/2" Type TG-C</td> </tr> <tr> <td>United States Gypsum Company</td> <td>-</td> <td>5/8" SHEETROCK® Brand FIRECODE® Core Gypsum Sheathing</td> </tr> <tr> <td></td> <td>-</td> <td>1/2" SHEETROCK® Brand FIRECODE® C Core Gypsum Panels</td> </tr> </table>		American Gypsum Company LLC	-	1/2" FireBloc® Type C	CertainTeed Gypsum Inc.	-	1/2" ProRoc® Type C Gypsum Panels	Lafarge North America Inc.	-	1/2" Firecheck® Type C	Temple-Inland	-	5/8" Sheathing Type TG-C		-	1/2" Type TG-C	United States Gypsum Company	-	5/8" SHEETROCK® Brand FIRECODE® Core Gypsum Sheathing		-	1/2" SHEETROCK® Brand FIRECODE® C Core Gypsum Panels		<p>Thickness: 53/4" - 57/8"                  Approx. Weight: 11 psf                  Fire Test: Based on UL R1319, 10-17-90, UL Design U474</p>
American Gypsum Company LLC	-	1/2" FireBloc® Type C																						
CertainTeed Gypsum Inc.	-	1/2" ProRoc® Type C Gypsum Panels																						
Lafarge North America Inc.	-	1/2" Firecheck® Type C																						
Temple-Inland	-	5/8" Sheathing Type TG-C																						
	-	1/2" Type TG-C																						
United States Gypsum Company	-	5/8" SHEETROCK® Brand FIRECODE® Core Gypsum Sheathing																						
	-	1/2" SHEETROCK® Brand FIRECODE® C Core Gypsum Panels																						
<b>GA FILE NO. WP 8250</b>	<b>PROPRIETARY*</b>	<b>2 HOUR FIRE</b>																						
<p><b>GYPSUM WALLBOARD, STEEL STUDS, GYPSUM SHEATHING, METAL LATH, CEMENT-LIME STUCCO, MINERAL FIBER INSULATION</b></p> <p>EXTERIOR SIDE: One layer 1/2" gypsum sheathing applied at right angles to 35/8" 20 gage steel studs 16" o.c. Self-furring metal lath, 3.4 lb, attached through sheathing to studs with 11/4" Type S-12 drywall screws 8" o.c. 1" portland cement-lime stucco applied over lath.</p> <p>INTERIOR SIDE: One layer 5/8" foil backed proprietary type X gypsum wallboard or gypsum veneer base applied parallel to studs with 1" Type S-12 drywall screws 8" o.c. 3" mineral fiber insulation, 2.0 pcf, in stud space. <b>(NLB)</b></p> <p style="text-align: center;"><b>PROPRIETARY GYPSUM BOARD</b></p> <table style="width: 100%; border: none;"> <tr> <td style="width: 30%;">United States Gypsum Company</td> <td style="width: 30%;">-</td> <td style="width: 30%;">5/8" SHEETROCK® Brand FIRECODE® C Core Foil-Back Gypsum Panels</td> </tr> </table>		United States Gypsum Company	-	5/8" SHEETROCK® Brand FIRECODE® C Core Foil-Back Gypsum Panels		<p>Thickness: 53/4"                  Approx. Weight: 20 psf                  Fire Test: OSU T-4851, 6-70</p>																		
United States Gypsum Company	-	5/8" SHEETROCK® Brand FIRECODE® C Core Foil-Back Gypsum Panels																						
<b>GA FILE NO. WP 8325</b>	<b>GENERIC</b>	<b>2 HOUR FIRE</b>																						
<p><b>GYPSUM WALLBOARD, STEEL STUDS, METAL LATH, PERLITE-CEMENT LIME PLASTER</b></p> <p>EXTERIOR SIDE: 11/2" x 17 gage galvanized woven wire self-furring paper backed lath attached to 35/8" 20 gage steel studs 16" o.c. with 1/2" Type S-12 pan head screws 6" o.c. 1" 6:1:1 perlite- portland cement-lime plaster applied over lath.</p> <p>INTERIOR SIDE: One layer 5/8" type X gypsum wallboard or gypsum veneer base applied parallel to studs with 1" Type S-12 drywall screws 12" o.c. 31/4" 6:1:1 perlite-portland cement-lime back plaster spray applied in stud space.</p> <p>Achieved 4 hours when tested from cement side. <b>(NLB)</b></p>			<p>Thickness: 51/4"                  Approx. Weight: 14 psf                  Fire Test: OSU 5645, 5-7-75</p>																					

\*Contact the manufacturer for more detailed information on proprietary products.

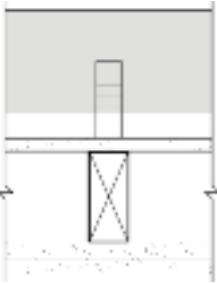
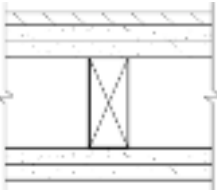
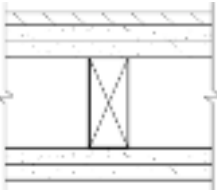
<b>EXTERIOR WALLS</b>																															
<p style="text-align: center; margin: 0;"><b>GA FILE NO. WP 8410</b></p>	<p style="text-align: center; margin: 0;"><b>GENERIC</b></p>	<p style="text-align: center; margin: 0;"><b>2 HOUR FIRE</b></p>																													
<p style="text-align: center; margin: 0;"><b>GYPSUM WALLBOARD, WOOD STUDS, GYPSUM SHEATHING, CLAY BRICK</b></p>			<p>Thickness: 10<sup>1</sup>/<sub>8</sub>" Fire Test: UL R1505-1, 2, 4-22-65, UL Design U302; ULC Design U302</p>																												
<p>EXTERIOR SIDE: <b>Base</b> layer 1/2" gypsum sheathing applied parallel or at right angles to 2 x 4 wood studs 16" o.c. with 1<sup>3</sup>/<sub>4</sub>" galvanized roofing nails, 0.125" shank, 7/16" heads, 6" o.c. <b>Face</b> layer 2" x 4" x 8" clay brick with 1" air space between brick and exterior sheathing. No. 20 gage galvanized wire ties attached to each stud with 8d coated nails, 2<sup>3</sup>/<sub>8</sub>" long, 0.113" shank, 9/32" head, at every 6th course of bricks.</p> <p>INTERIOR SIDE: <b>Base</b> layer 5/8" type X gypsum wallboard or gypsum veneer base applied parallel or at right angles to studs with 6d coated nails, 1<sup>7</sup>/<sub>8</sub>" long, 0.0915" shank, 1/4" heads, 8" o.c. <b>Face</b> layer 5/8" type X gypsum wallboard or gypsum veneer base applied parallel to or at right angles to studs with 8d coated nails, 2<sup>3</sup>/<sub>8</sub>" long, 0.113" shank, 9/32" heads, 8" o.c. <b>(LOAD-BEARING)</b></p>																															
<p style="text-align: center; margin: 0;"><b>GA FILE NO. WP 8415</b></p>	<p style="text-align: center; margin: 0;"><b>GENERIC</b></p>	<p style="text-align: center; margin: 0;"><b>2 HOUR FIRE</b></p>																													
<p style="text-align: center; margin: 0;"><b>GYPSUM SHEATHING, GYPSUM WALLBOARD, WOOD STUDS</b></p>			<p>Thickness: 6<sup>1</sup>/<sub>8</sub>" without exterior cladding Fire Test: See WP 4135 (FM WP 360, 9-27-74)</p>																												
<p>EXTERIOR SIDE: <b>Base</b> layer 5/8" type X gypsum sheathing applied parallel or at right angles to 2 x 4 wood studs 24" o.c. with 6d coated nails, 1<sup>7</sup>/<sub>8</sub>" long, 0.085" shank, 1/4" heads, 24" o.c. <b>Face</b> layer 5/8" type X gypsum sheathing applied parallel or at right angles to studs with 8d coated nails, 2<sup>3</sup>/<sub>8</sub>" long, 0.100" shank, 1/4" heads, 8" o.c. Exterior cladding attached through sheathing to studs.</p> <p>INTERIOR SIDE: <b>Base</b> layer 5/8" type X gypsum wallboard or gypsum veneer base applied parallel or at right angles to studs with 6d coated nails, 1<sup>7</sup>/<sub>8</sub>" long, 0.085" shank, 1/4" heads, 24" o.c. <b>Face</b> layer 5/8" type X gypsum wallboard or gypsum veneer base applied parallel or at right angles to studs with 8d coated nails, 2<sup>3</sup>/<sub>8</sub>" long, 0.100" shank, 1/4" heads, 8" o.c.</p> <p>Joints staggered 24" each layer and side. <b>(LOAD-BEARING)</b></p>																															
<p style="text-align: center; margin: 0;"><b>GA FILE NO. WP 8416</b></p>	<p style="text-align: center; margin: 0;"><b>PROPRIETARY*</b></p>	<p style="text-align: center; margin: 0;"><b>2 HOUR FIRE</b></p>																													
<p style="text-align: center; margin: 0;"><b>GYPSUM WALLBOARD, GLASS MAT GYPSUM SUBSTRATE, WOOD STUDS</b></p>			<p>Thickness: 6<sup>1</sup>/<sub>8</sub>" Approx. Weight: 12 psf Fire Test: Based on UL R3660/R15187, 2-4-02; UL R6937, 08NK02787, 9-19-08; UL Design U301</p>																												
<p>EXTERIOR SIDE: <b>Base</b> layer 5/8" proprietary type X glass mat gypsum substrate (sheathing) applied parallel or at right angles to 2 x 4 wood studs 16" o.c. with 1<sup>7</sup>/<sub>8</sub>", 0.0915" shank, 1/4" head, galvanized roofing nails 6" o.c. <b>Face</b> layer 5/8" proprietary type X glass mat gypsum substrate (sheathing) applied parallel or at right angles to studs to with 2<sup>3</sup>/<sub>8</sub>", 0.113" shank, 9/32" head, galvanized roofing nails 8" o.c. Exterior cladding to be attached through glass mat gypsum panel to studs.</p> <p>INTERIOR SIDE: <b>Base</b> layer 5/8" proprietary type X gypsum board applied parallel or at right angles to studs with 1<sup>7</sup>/<sub>8</sub>", 0.0915" shank, 1/4" head nails 6" o.c. <b>Face</b> layer 5/8" proprietary type X gypsum board applied parallel or at right angles to studs with 2<sup>3</sup>/<sub>8</sub>", 0.113" shank, 9/32" head nails 8" o.c.</p> <p>Joints staggered 16" each layer and side. <b>(LOAD-BEARING)</b></p>																															
<p style="text-align: center; margin: 0;"><b>PROPRIETARY GYPSUM PANEL PRODUCTS</b></p> <table style="width: 100%; border-collapse: collapse;"> <tr> <td style="width: 30%;">CertainTeed Gypsum Inc.</td> <td style="width: 10%; text-align: center;">-</td> <td style="width: 30%;">5/8" ProRoc® Type X Gypsum Panels</td> <td style="width: 30%;"></td> </tr> <tr> <td></td> <td style="text-align: center;">-</td> <td>5/8" GlasRoc® Sheathing Type X Gypsum Panels</td> <td></td> </tr> <tr> <td>CertainTeed Gypsum Canada Inc.</td> <td style="text-align: center;">-</td> <td>5/8" ProRoc® Type X Gypsum Panels</td> <td></td> </tr> <tr> <td>National Gypsum Company</td> <td style="text-align: center;">-</td> <td>5/8" e2XP® FIRE-SHIELD® Gypsum Sheathing</td> <td></td> </tr> <tr> <td></td> <td style="text-align: center;">-</td> <td>5/8" Gold Bond® Brand FIRE-SHIELD® Gypsum Board</td> <td></td> </tr> <tr> <td>Temple-Inland</td> <td style="text-align: center;">-</td> <td>5/8" GreenGlass Type X</td> <td></td> </tr> <tr> <td></td> <td style="text-align: center;">-</td> <td>5/8" Type X</td> <td></td> </tr> </table>				CertainTeed Gypsum Inc.	-	5/8" ProRoc® Type X Gypsum Panels			-	5/8" GlasRoc® Sheathing Type X Gypsum Panels		CertainTeed Gypsum Canada Inc.	-	5/8" ProRoc® Type X Gypsum Panels		National Gypsum Company	-	5/8" e2XP® FIRE-SHIELD® Gypsum Sheathing			-	5/8" Gold Bond® Brand FIRE-SHIELD® Gypsum Board		Temple-Inland	-	5/8" GreenGlass Type X			-	5/8" Type X	
CertainTeed Gypsum Inc.	-	5/8" ProRoc® Type X Gypsum Panels																													
	-	5/8" GlasRoc® Sheathing Type X Gypsum Panels																													
CertainTeed Gypsum Canada Inc.	-	5/8" ProRoc® Type X Gypsum Panels																													
National Gypsum Company	-	5/8" e2XP® FIRE-SHIELD® Gypsum Sheathing																													
	-	5/8" Gold Bond® Brand FIRE-SHIELD® Gypsum Board																													
Temple-Inland	-	5/8" GreenGlass Type X																													
	-	5/8" Type X																													
<p><i>*Contact the manufacturer for more detailed information on proprietary products.</i></p>																															

**EXTERIOR WALLS**

<b>GA FILE NO. WP 8417</b>	<b>PROPRIETARY*</b>	<b>2 HOUR FIRE</b>
<p align="center"><b>GYPSUM WALLBOARD, WOOD STUDS, GYPSUM SHEATHING, STUCCO NETTING, CEMENT STUCCO</b></p>		
<p>EXTERIOR SIDE: <b>Base</b> layer 5/8" proprietary type X gypsum sheathing applied parallel or at right angles to 2 x 4 wood studs 16" o.c. with 1 3/4", 0.125" shank, 7/16" head galvanized roofing nails 8" o.c. or 2" Type S drywall screws 8" o.c. Pre-furred wire stucco netting applied over gypsum sheathing with 1 1/4" x 1" steel staples 7" o.c. Portland cement stucco, 3/4", applied over stucco netting.</p>		<p>Thickness: 6 1/4"                  Approx. Weight: 17 psf                  Fire Test: UL R3501, 03NK2475, 5-21-03, UL Design U371</p>
<p>INTERIOR SIDE: <b>Base</b> layer 5/8" proprietary type X gypsum wallboard or gypsum veneer base applied parallel or at right angles to studs with 1 1/4" Type S drywall screws 12" o.c. <b>Face</b> layer 5/8" proprietary type X gypsum wallboard or gypsum veneer base applied parallel or at right angles to studs with 2" Type S drywall screws 12" o.c.</p>		
<p>Joists staggered 16" each layer and side. <b>(LOAD-BEARING)</b></p>		
<p align="center"><b>PROPRIETARY GYPSUM BOARD</b></p>		
<p>National Gypsum Company</p>	<ul style="list-style-type: none"> <li>- 5/8" Gold Bond® Brand FIRE-SHIELD® Gypsum Board</li> </ul>	
	<ul style="list-style-type: none"> <li>- 5/8" Gold Bond® Brand FIRE-SHIELD® Gypsum Sheathing</li> </ul>	

<b>GA FILE NO. WP 8420</b>	<b>GENERIC</b>	<b>2 HOUR FIRE</b>
<p align="center"><b>WOOD STUDS, CEMENT STUCCO, WIRE MESH, GYPSUM WALLBOARD</b></p>		<p align="center">FIRE SIDE</p>
<p>EXTERIOR SIDE: <b>Base</b> layer 5/8" type X gypsum sheathing applied parallel to 2 x 6 fire retardant treated wood studs 16" o.c. with 6d coated nails, 1 7/8" long, 0.0915" shank, 1/4" heads, 12" o.c. and covered with a single layer fire resistant protective weather retarder paper stapled along each edge at 16" o.c. Galvanized self-furring wire mesh applied over sheathing with 8d galvanized roofing nails, 2 3/8" long, 0.113" shank, 9/32" heads, 6" o.c. Cement-stucco applied over wire mesh in two 1/2" thick coats with bonding agent applied between coats.</p>		
<p>INTERIOR SIDE: <b>Base</b> layer 5/8" type X gypsum wallboard or gypsum veneer base applied parallel to studs with 6d coated nails, 1 7/8" long, 0.0915" shank, 1/4" heads, 12" o.c. <b>Face</b> layer 5/8" type X gypsum wallboard or gypsum veneer base applied at right angles to studs with 8d coated nails, 2 3/8" long, 0.113" shank, 9/32" heads, 8" o.c. at edges and 12" o.c. at intermediate studs. <b>(LOAD-BEARING)</b></p>		<p>Thickness: 8 5/8"                  Fire Test: UC, 12-21-67</p>

**This Space Left Blank**

*\*Contact the manufacturer for more detailed information on proprietary products.*

**METAL CLAD EXTERIOR WALLS**

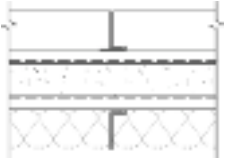
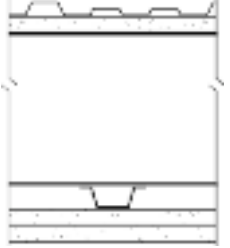
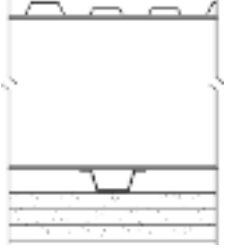
<p><b>GA FILE NO. WP 9010</b></p>	<p><b>GENERIC</b></p>	<p><b>1 HOUR FIRE</b></p>
<p align="center"><b>GYPSUM WALLBOARD, STEEL LINER, STEEL FACIA, GLASS FIBER INSULATION</b></p> <p>Coated steel interlocking interior liner panels attached to top and bottom supporting angles with 3/4"-14 steel screws. 1 1/2" glass fiber insulation batts, 0.6 pcf, applied horizontally. 16 gage coated steel hat-shaped subgirts 1/2" deep x 2 1/2" wide with 1 1/16" legs screw attached to legs of liner panels and to top and bottom supporting angles. Subgirts spaced horizontally 3" from top and bottom of liner panels with intermediate subgirts spaced 36" minimum, 48" maximum. <b>Base</b> layer 5/8" type X gypsum wallboard applied at right angles to subgirts with 1 5/8" Type S-12 drywall screws spaced 12" from vertical edges. <b>Second</b> layer 5/8" type X gypsum wallboard applied at right angles to subgirts with 1 5/8" Type S-12 drywall screws spaced 6" from vertical joints into each subgirt. Joints offset 26" from base layer joints. 16 gage hat-shaped metal coated steel subgirts 7/16" deep x 2 3/4" wide with 1/2" legs attached horizontally to first subgirts and gypsum wallboard with 2 3/8"-14 steel screws 24" o.c. Exterior steel or protected steel facing units of various shapes attached vertically to subgirts with U-shaped, coated, 18 gage spring steel clips hooked over lips of facing units and screw attached to subgirts with 3/4"-14 steel screws. Facing units secured along vertical joints with 3/4"-12 steel screws 18" o.c. 24" wide steel liner panels and 12" wide steel facing units are 1 1/2" deep and 20 gage. <b>(NLB)</b></p>		 <p>Thickness: 5" Approx. Weight: 8 psf Fire Test: UL R4013-14, 12-23-69, UL Design U617</p>
<p><b>GA FILE NO. WP 9020</b></p>	<p><b>GENERIC</b></p>	<p><b>1 HOUR FIRE</b></p>
<p align="center"><b>GYPSUM WALLBOARD, GYPSUM SHEATHING, RIGID FURRING CHANNELS, STEEL GIRTS, STEEL WALL PANELS</b></p> <p><b>EXTERIOR SIDE:</b> <b>Base</b> layer 5/8" type X gypsum sheathing applied at right angles to horizontal, 6" to 12" deep, "Z" or "C" shaped, 0.056" to 0.120" thick steel girts 48" o.c. with 1 1/4" Type S-12 drywall screws 8" o.c. <b>Face</b> layer minimum 26 gage steel exterior wall panels applied at right angles to girts with 1 1/2" long, No. 12-14 self-drilling screws 12" o.c. Joints offset 6" from gypsum sheathing joints.</p> <p><b>INTERIOR SIDE:</b> <b>Base</b> layer 5/8" type X gypsum wallboard applied parallel or at right angles to rigid furring channels 24" o.c. with 1" Type S drywall screws 24" o.c. Furring channels attached at right angles to girts with two 3/8" long, Type S-12 panhead screws at each girt. <b>Face</b> layer 5/8" type X gypsum wallboard applied parallel or at right angles to channels with 1 5/8" Type S drywall screws 12" o.c. Joints offset 24" from base layer joints. <b>(LOAD-BEARING)</b></p>		 <p>Thickness: Varies Approx. Weight: 8 psf Fire Test: UL R7406, R4024; 96NK36592; 8-23-99; UL Design V421</p>
<p><b>GA FILE NO. WP 9021</b></p>	<p><b>GENERIC</b></p>	<p><b>1 HOUR FIRE</b></p>
<p align="center"><b>GYPSUM WALLBOARD, RIGID FURRING CHANNELS, STEEL GIRTS, STEEL WALL PANELS</b></p> <p><b>EXTERIOR SIDE:</b> Minimum 26 gage steel exterior wall panels applied at right angles to horizontal, 6" to 12" deep, "Z" or "C" shaped, 0.056" to 0.120" thick steel girts 48" o.c. with 1 1/2" long, No. 12-14 self-drilling screws 12" o.c.</p> <p><b>INTERIOR SIDE:</b> <b>Base</b> layer 5/8" type X gypsum wallboard applied parallel or at right angles to rigid furring channels 24" o.c. with 1" Type S drywall screws 24" o.c. Furring channels attached at right angles to girts with two 3/8" long, Type S-12 panhead screws at each girt. <b>Second</b> layer 5/8" type X gypsum wallboard applied parallel or at right angles to channels with 1 5/8" Type S drywall screws 12" o.c. Joints offset 24" from base layer joints. <b>Face</b> layer 5/8" type X gypsum wallboard applied parallel or at right angles to channels with 2 1/4" Type S drywall screws 12" o.c. Joints offset 24" from second layer joints. <b>(LOAD-BEARING)</b></p>		 <p align="right">FIRE SIDE</p> <p>Thickness: Varies Approx. Weight: 8 psf Fire Test: UL R7406, R4024; 96NK36592; 8-23-99; UL Design V421</p>

**METAL CLAD EXTERIOR WALLS**

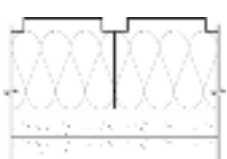
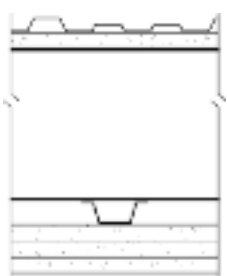
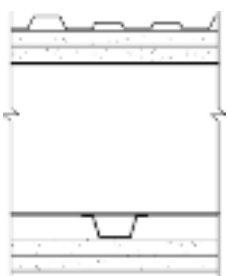

<p><b>GA FILE NO. WP 9060</b></p> <p><b>GYPSUM WALLBOARD, STEEL FURRING CHANNELS, STEEL PANELS, GLASS FIBER INSULATION</b></p> <p>Steel furring channels 24" o.c. attached at right angles to legs of exterior panels with 1" Type S drywall screws 16" o.c.</p> <p>EXTERIOR SIDE: Exterior panels consist of fluted steel wall panels, 24 gage steel, 16" wide, having J shaped 3" deep legs which interlock along vertical edges. 3" glass fiber insulation 1.0 pcf friction fit in panel cavity.</p> <p>INTERIOR SIDE: <b>Base</b> layer 5/8" type X gypsum wallboard or gypsum veneer base attached with 1" Type S drywall screws 12" o.c. at right angles to steel furring channels. <b>Face</b> layer 5/8" type X gypsum wallboard or gypsum veneer base laminated at right angles to furring channels and attached with 17/8" Type S drywall screws 12" o.c. at top and bottom edges. Alternately, <b>base</b> layer applied with 1" Type S drywall screws 24" o.c. at vertical joints and <b>face</b> layer applied with 17/8" Type S drywall screws 12" o.c. Face layer joints offset 16" from base layer joints. <b>(NLB)</b></p>	<p><b>GENERIC</b></p>	<p><b>1 HOUR FIRE</b></p>  <p>Thickness: 4 5/8"                  Approx. Weight: 7 psf                  Fire Test: FM WP 155-1, 1-31-69;                  FM WP 167-1, 9-18-69</p>
<p><b>GA FILE NO. WP 9200</b></p> <p><b>GYPSUM WALLBOARD, GYPSUM SHEATHING, RIGID FURRING CHANNELS, STEEL GIRTS, STEEL WALL PANELS</b></p> <p>EXTERIOR SIDE: <b>Base</b> layer 5/8" type X gypsum sheathing applied at right angles to horizontal, 6" to 12" deep, "Z" or "C" shaped, 0.056" to 0.120" thick steel girts 48" o.c. with 1 1/4" Type S-12 drywall screws 8" o.c. <b>Face</b> layer minimum 26 gage steel exterior wall panels applied at right angles to girts with 1 1/2" long, No. 12-14 self-drilling screws 12" o.c. Joints offset 6" from gypsum sheathing joints.</p> <p>INTERIOR SIDE: <b>Base</b> layer 5/8" type X gypsum wallboard applied parallel or at right angles to rigid furring channels 24" o.c. with 1" Type S drywall screws 24" o.c. Furring channels attached at right angles to girts with two 3/8" long, Type S-12 panhead screws at each girt. <b>Second</b> layer 5/8" type X gypsum wallboard applied parallel or at right angles to channels with 1 5/8" Type S drywall screws 12" o.c. Joints offset 24" from base layer joints. <b>Face</b> layer 5/8" type X gypsum wallboard applied parallel or at right angles to channels with 2 1/4" Type S drywall screws 12" o.c. Joints offset 24" from second layer joints. <b>(LOAD-BEARING)</b></p>	<p><b>GENERIC</b></p>	<p><b>2 HOUR FIRE</b></p>  <p>Thickness: Varies                  Approx. Weight: 9.5 psf                  Fire Test: UL R7406, R4024;                  96NK36592; 8-23-99;                  UL Design V421</p>
<p><b>GA FILE NO. WP 9205</b></p> <p><b>GYPSUM WALLBOARD, GYPSUM SHEATHING, RIGID FURRING CHANNELS, STEEL GIRTS, STEEL WALL PANELS</b></p> <p>EXTERIOR SIDE: <b>Base</b> layer 5/8" type X gypsum sheathing applied at right angles to horizontal, 6" to 12" deep, "Z" or "C" shaped, 0.056" to 0.120" thick steel girts 48" o.c. with 1 1/4" Type S-12 drywall screws 8" o.c. <b>Second</b> layer 5/8" type X gypsum sheathing applied at right angles to girts with 1 5/8" type S-12 drywall screws 8" o.c. Vertical joints offset 24" from base layer joints. <b>Face</b> layer minimum 26 gage steel exterior wall panels applied at right angles to girts with 2" long, No. 12-14 self-drilling screws 12" o.c. Joints offset 6" from gypsum sheathing joints.</p> <p>INTERIOR SIDE: <b>Base</b> layer 5/8" type X gypsum wallboard applied parallel or at right angles to rigid furring channels 24" o.c. with 1" Type S drywall screws 24" o.c. Furring channels attached at right angles to girts with two 3/8" long, Type S-12 panhead screws at each girt. <b>Face</b> layer 5/8" type X gypsum wallboard applied parallel or at right angles to channels with 1 5/8" Type S drywall screws 12" o.c. Joints offset 24" from base layer joints. <b>(LOAD-BEARING)</b></p>	<p><b>GENERIC</b></p>	<p><b>2 HOUR FIRE</b></p>  <p>Thickness: Varies                  Approx. Weight: 9.5 psf                  Fire Test: UL R7406, R4024;                  96NK36592; 8-23-99;                  UL Design V421</p>

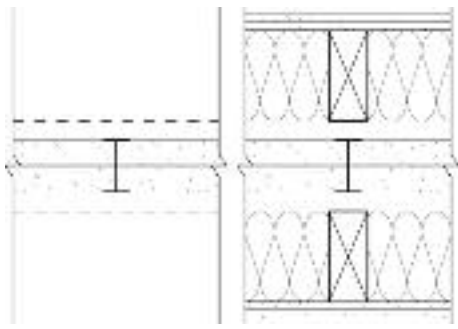
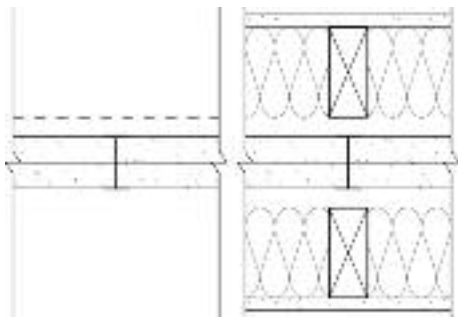
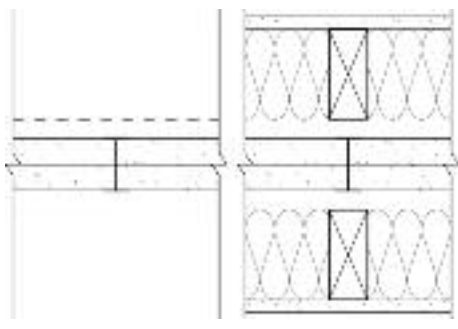

METAL CLAD EXTERIOR WALLS			
<p><b>GA FILE NO. WP 9206</b></p>	<p><b>GENERIC</b></p>	<p><b>2 HOUR FIRE</b></p>	
<p align="center"><b>GYPSUM WALLBOARD, RIGID FURRING CHANNELS, STEEL GIRTS, STEEL WALL PANELS</b></p> <p>EXTERIOR SIDE: Minimum 26 gage steel exterior wall panels applied at right angles to horizontal, 6" to 12" deep, "Z" or "C" shaped, 0.056" to 0.120" thick steel girts 48" o.c. with 1 1/2" long, No. 12-14 self-drilling screws 12" o.c.</p> <p>INTERIOR SIDE: <b>Base</b> layer 5/8" type X gypsum wallboard applied parallel or at right angles to rigid furring channels 24" o.c. with 1" Type S drywall screws 24" o.c. Furring channels attached at right angles to girts with two 3/8" long, Type S-12 panhead screws at each girt. <b>Second</b> layer 5/8" type X gypsum wallboard applied parallel or at right angles to channels with 1 5/8" Type S drywall screws 12" o.c. Joints offset 24" from base layer joints. <b>Third</b> layer 5/8" type X gypsum wallboard applied parallel or at right angles to channels with 1 7/8" Type S drywall screws 12" o.c. Joints offset 24" from second layer joints. Steel straps, 0.020" x 1 1/2" wide, vertically applied over third layer at vertical joints and intermediate channels with 2 5/8" Type S drywall screws 12" o.c. <b>Face</b> layer 5/8" type X gypsum wallboard applied parallel or at right angles to steel straps with 1" Type S drywall screws 8" o.c. Joints offset 24" from third layer joints. <b>(LOAD-BEARING)</b></p>			<p align="right">FIRE SIDE</p> <p>Thickness: Varies                  Approx. Weight: 9.5 psf                  Fire Test: UL R7406, R4024; 96NK36592; 8-23-99; UL Design V421</p>
<p><b>GA FILE NO. WP 9225</b></p>	<p><b>GENERIC</b></p>	<p><b>2 HOUR FIRE</b></p>	
<p align="center"><b>SOLID GYPSUM WALLBOARD, METAL FACINGS, GLASS FIBER INSULATION</b></p> <p>Coated steel interlocking interior liner panels attached to top and bottom supporting angles with 3/4"-14 steel screws. 1 1/2" glass fiber insulation batts, 0.6 pcf, applied horizontally. 16 gage coated steel hat-shaped subgirts 3/8" deep x 2 1/2" wide with 5/8" legs screw attached to lips of liner panels and to top and bottom supporting angles. Subgirts spaced horizontally 3" from top and bottom of liner panels with intermediate subgirt spaced 36" minimum, 48" maximum. <b>Base</b> layer 5/8" type X gypsum wallboard applied at right angles subgirts with 1 5/8" Type S-12 drywall screws spaced 12" from vertical joints. <b>Second</b> layer 5/8" type X gypsum wallboard applied at right angles to subgirts with 1 5/8" Type S-12 drywall screws spaced 6" from vertical joints into each subgirt. Joints offset 24" from base layer joints. <b>Third</b> layer 5/8" type X gypsum wallboard applied with 1 1/2" Type G drywall screws spaced 12" from vertical joints and over subgirts. Joints offset 8" from second layer joints. 18 gage hat-shaped metal coated steel subgirts 3/8" deep x 3" wide with 9/16" legs attached horizontally to first subgirt over gypsum wallboard with 2 5/8" Type S-12 drywall screws 24" o.c. Exterior steel or protected steel facing units of various shapes attached vertically to subgirts with U-shaped, coated, 14 gage spring steel clips hooked over lips of facing units and screw attached to subgirts with 3/4"-12 steel screws. Facing units secured along vertical joints with 3/4"-12 steel screws 18" o.c. 24" wide steel liner panels and 12" wide steel facing units are 1 1/2" deep x 20 gage. <b>(NLB)</b></p>			<p>Thickness: 5 9/16"                  Fire Test: UL R4013-15, 1-8-71, UL Design U602</p>
<p><b>GA FILE NO. WP 9325</b></p>	<p><b>GENERIC</b></p>	<p><b>2 HOUR FIRE</b></p>	
<p align="center"><b>GYPSUM WALLBOARD, STEEL FURRING CHANNELS, METAL PANELS, GLASS FIBER INSULATION</b></p> <p>Steel furring channels 24" o.c. attached at right angles to legs of exterior panels with 1" Type S drywall screws 16" o.c.</p> <p>EXTERIOR SIDE: Exterior panels consist of fluted steel wall panels, 24 gage steel, 16" wide, having J shaped 3" deep legs which interlock along vertical edges. 3" glass fiber insulation, 1.0 pcf, friction fit in panel cavity.</p> <p>INTERIOR SIDE: <b>Base</b> layer 1/2" type X gypsum wallboard or gypsum veneer base applied at right angles to furring channels with 1" Type S drywall screws 24" o.c. <b>Second</b> layer 1/2" type X gypsum wallboard or gypsum veneer base applied at right angles to furring channels with 1 7/8" Type S drywall screws 24" o.c. Vertical joints offset 16" from base layer joints. Steel furring channels placed over the layer directly over the first rows of furring channels and attached thereto with 1 7/8" Type S drywall screws 16" o.c. <b>Third</b> layer 1/2" type X gypsum wallboard or gypsum veneer base applied at right angles to furring channels with 1" Type S drywall screws 24" o.c. <b>Face</b> layer 1/2" type X gypsum wallboard or gypsum veneer base applied at right angles to furring channels with 1 7/8" Type S drywall screws 12" o.c. <b>(LOAD-BEARING)</b></p>			<p align="right">FIRE SIDE</p> <p>Thickness: 5 3/4"                  Approx. Weight: 11 psf                  Fire Test: FM WP 150-2, 11-15-68</p>

<b>AREA SEPARATION FIRE WALLS</b>			
<b>GA FILE NO. ASW 0800</b>	<b>PROPRIETARY*</b>	<b>2 HOUR FIRE</b>	<b>65 to 69 STC SOUND</b>
<p style="text-align: center;"><b>GYPSUM PANEL PRODUCTS, STEEL H STUDS</b></p> <p>Two layers 1" x 24" proprietary type X gypsum panels inserted between 2" floor and ceiling runners with 2" steel H studs between adjacent pairs of gypsum panels. <b>(NLB)</b></p> <p>A 3/4" minimum air space must be maintained between steel components and adjacent framing (indicated by dashed lines in sketch). As an alternate, the steel components may be covered with 6" wide battens or full sheets of 1/2" type X gypsum wallboard.</p> <p>Sound tested with 2 x 4 stud wall faced with 5/8" proprietary gypsum panel product each side of system and 3 1/2" glass fiber insulation in stud space.</p> <p style="text-align: center;"><b>PROPRIETARY GYPSUM PANEL PRODUCTS</b></p> <p>National Gypsum Company - 1" Gold Bond® Brand FIRE-SHIELD® Shaftliner                      - 5/8" Gold Bond® Brand SoundBreak® Gypsum Board</p>		 <p>Thickness: 3 1/2" (Fire) 12" (Sound)</p> <p>Approx. Weight: 9 psf</p> <p>Fire Test: UL R3501, 05NK28782, 4-13-06, UL Design U347</p> <p>Sound Test: NRCC B-3451.1, 10-5-06</p>	
<b>GA FILE NO. ASW 0980</b>	<b>PROPRIETARY*</b>	<b>2 HOUR FIRE</b>	<b>60 to 64 STC SOUND</b>
<p style="text-align: center;"><b>GYPSUM WALLBOARD, STEEL H STUDS</b></p> <p>Two layers 1" x 24" proprietary type X gypsum panels inserted between 2" floor and ceiling runners with H studs between adjacent pairs of gypsum panels. <b>(NLB)</b></p> <p>A 3/4" minimum air space must be maintained between steel components and adjacent framing (as indicated by dashed lines in sketch). As an alternate to an air space, the steel components are covered with 6" wide battens or full sheets of 1/2" type X gypsum board screw attached to the steel components.</p> <p>Sound tested with 2 x 4 stud wall faced with 1/2" regular gypsum wallboard each side of assembly and 3 1/2" glass fiber in stud space on both sides.</p> <p style="text-align: center;"><b>PROPRIETARY GYPSUM BOARD</b></p> <p>Lafarge North America Inc. - 1" Mold Defense® Shaftliner</p>		 <p>Thickness: 3 1/2" (Fire) 11 3/4" (Sound)</p> <p>Approx. Weight: 9 psf</p> <p>Fire Test: WHI-495-1396/1398, 6-26-98; ITS Design LG/WA 120-03; ITS Design LG/WA 120-04</p> <p>Sound Test: RAL TL08-176, 6-25-08</p>	
<b>GA FILE NO. ASW 0985</b>	<b>PROPRIETARY*</b>	<b>2 HOUR FIRE</b>	<b>60 to 64 STC SOUND</b>
<p style="text-align: center;"><b>GYPSUM WALLBOARD, STEEL H STUDS</b></p> <p>Two layers 1" x 24" proprietary type X gypsum panels inserted between 2" floor and ceiling runners with 2" steel H studs between adjacent pairs of gypsum panels. <b>(NLB)</b></p> <p>A 3/4" minimum air space must be maintained between steel components and adjacent framing (indicated by dashed lines in sketch). As an alternate, the steel components may be covered with 6" wide battens or full sheets of 1/2" type X gypsum wallboard.</p> <p>Sound tested with 2 x 4 stud wall faced with 1/2" gypsum wallboard each side of system and 3 1/2" glass fiber insulation in stud space.</p> <p style="text-align: center;"><b>PROPRIETARY GYPSUM BOARD</b></p> <p>PABCO Gypsum - 1" PABCORE® Gypsum Shaftliner Board Type X</p>		 <p>Thickness: 3 1/2" (Fire) 11 3/4" (Sound)</p> <p>Approx. Weight: 9 psf</p> <p>Fire Test: WFCi #07073, 2-18-08</p> <p>Sound Test: RAL TL07-373, 12-4-07</p>	

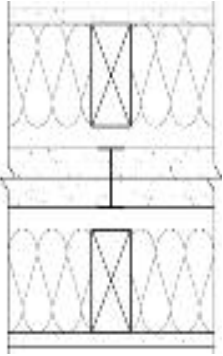
\*Contact the manufacturer for more detailed information on proprietary products.

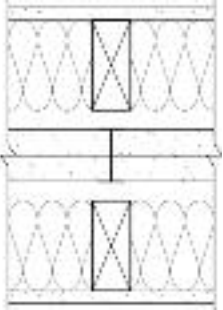



AREA SEPARATION FIRE WALLS			
GA FILE NO. ASW 0998	PROPRIETARY*	2 HOUR FIRE	60 to 64 STC SOUND
<p align="center"><b>GYPSUM WALLBOARD, STEEL H STUDS</b></p> <p>Two layers 1" x 24" proprietary type X gypsum panels inserted between 2" floor and ceiling runners with 2" steel H studs between adjacent pairs of gypsum panels. <b>(NLB)</b></p> <p>A 3/4" minimum air space must be maintained between steel components and adjacent framing (indicated by dashed lines in sketch). As an alternate, the steel components may be covered with 6" wide battens or full sheets of 1/2" type X gypsum wallboard.</p> <p>Sound tested with 2 x 4 stud wall faced with 1/2" gypsum wallboard each side of system and 3 1/2" glass fiber insulation in stud space.</p> <p align="center"><b>PROPRIETARY GYPSUM BOARD</b></p> <p>National Gypsum Company - 1" Gold Bond® Brand FIRE-SHIELD® Shaftliner</p>			
<p>Thickness: 3 1/2" (Fire) 11 3/4" (Sound)</p> <p>Approx. Weight: 9 psf</p> <p>Fire Test: UL R3501, 92NK28896, 6-7-93, UL Design U347; WHI 694-0200.6, 10-21 &amp; 24-85</p> <p>Sound Test: RAL TL05-199, 11-17-05</p>			
GA FILE NO. ASW 0999	PROPRIETARY*	2 HOUR FIRE	60 to 64 STC SOUND
<p align="center"><b>GYPSUM PANEL PRODUCTS, STEEL H STUDS</b></p> <p>Two layers 1" x 24" proprietary type X gypsum panels inserted between 2" floor and ceiling runners with 2" steel H studs between adjacent pairs of gypsum panels. <b>(NLB)</b></p> <p>A 3/4" minimum air space must be maintained between steel components and adjacent framing (indicated by dashed lines in sketch).</p> <p>Sound tested with 2 x 4 stud wall faced with 1/2" regular gypsum wallboard each side of system and 3 1/2" glass fiber insulation in stud space.</p> <p align="center"><b>PROPRIETARY GYPSUM PANEL PRODUCT</b></p> <p>CertainTeed Gypsum Inc. - 1" GlasRoc® Shaftliner Gypsum Panels</p>			
<p>Thickness: 3 1/2" (Fire) 11 3/4" (Sound)</p> <p>Approx. Weight: 9 psf</p> <p>Fire Test: UL R3660, 07NK22992, 2-18-08, UL Design U366</p> <p>Sound Test: RAL TL00-176, 12-6-00</p>			

*\*Contact the manufacturer for more detailed information on proprietary products.*

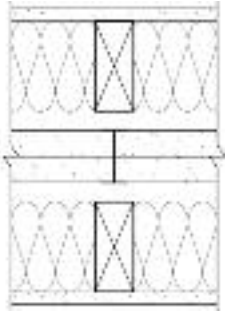

<b>AREA SEPARATION FIRE WALLS</b>			
<b>GA FILE NO. ASW 1000</b>	<b>PROPRIETARY*</b>	<b>2 HOUR FIRE</b>	<b>60 to 64 STC SOUND</b>
<b>GYPSUM WALLBOARD, STEEL H STUDS</b>			
<p>Two layers 1" x 24" proprietary type X gypsum panels inserted between 2" floor and ceiling runners with 2" steel H studs between adjacent pairs of gypsum panels. <b>(NLB)</b></p> <p>A 3/4" minimum air space must be maintained between steel components and adjacent framing (as indicated by dashed lines in sketch). As an alternate to an air space, the steel components are covered with 6" wide battens of 1/2" gypsum board or 1" mineral fiber insulation. As an alternate to battens, one or both faces of the separation wall are covered with 1" mineral fiber insulation stapled to the gypsum liner panels or 1/2" regular gypsum board screw attached to the steel components.</p> <p>Sound tested with 2 x 4 stud wall faced with 1/2" regular gypsum wallboard each side of assembly and 3" mineral fiber in stud space on both sides.</p>			
<b>PROPRIETARY GYPSUM BOARD</b>		<p>Thickness: 3 1/2" (Fire) 11 3/4" (Sound)</p> <p>Approx. Weight: 9 psf</p> <p>Fire Test: UL R1319, 89NK28786, 5-14-90, UL Design U336; UL R1319, 94NK40690, 1-27-95, UL Design V411; WHI 495-PSV-1245, 4-28-83</p> <p>Sound Test: RAL TL88-350, 9-12-88</p>	
<p>United States Gypsum Company - 1" SHEETROCK® Brand Gypsum Liner Panels</p>			
<b>GA FILE NO. ASW 1002</b>	<b>PROPRIETARY*</b>	<b>2 HOUR FIRE</b>	<b>60 to 64 STC SOUND</b>
<b>GYPSUM PANEL PRODUCTS, STEEL H STUDS</b>			
<p>Two layers 1" x 24" proprietary type X gypsum panels inserted between floor and ceiling runners with steel H stud between adjacent pairs of gypsum panels. <b>(NLB)</b></p> <p>A 3/4" minimum air space must be maintained between steel components and adjacent framing (as indicated by dashed lines in sketch). As an alternate to an air space, the steel components are covered with 6" wide battens of 1/2" type X gypsum wallboard or full sheets of 1/2" type X gypsum wallboard screw attached to the steel components.</p> <p>Sound tested with 2 x 4 stud wall faced with 1/2" regular gypsum wallboard each side of assembly and 3 1/2" glass fiber in stud space on both sides.</p>			
<b>PROPRIETARY GYPSUM PANEL PRODUCT</b>		<p>Thickness: 3 1/2" (Fire) 11 3/4" (Sound)</p> <p>Approx. Weight: 9.5 psf</p> <p>Fire Test: WHI 495-1290, 11-15-94; ITS Design GP/WA 120-04; WHI 495-1295, 3-15-95; WHI 495-0743 &amp; 0744, 1-28 &amp; 30-86; UL R2717, 04NK03115, 8-18-04, UL Design U373</p> <p>Sound Test: Based on RAL TL89-383, 11-10-89</p>	
<p>Georgia-Pacific Gypsum LLC - 1" DensGlass® Ultra Shaftliner™</p>			

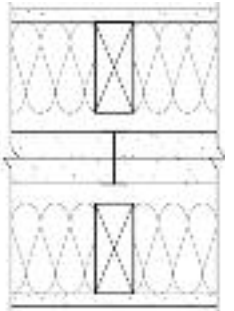
\*Contact the manufacturer for more detailed information on proprietary products.

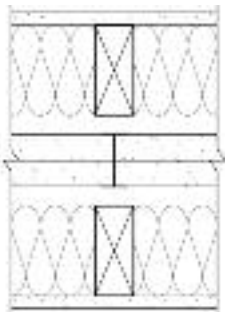
**AREA SEPARATION FIRE WALLS**

GA FILE NO. ASW 1003	PROPRIETARY*	2 HOUR FIRE	60 to 64 STC SOUND
<p style="text-align: center;"><b>GYPSUM WALLBOARD, STEEL H STUDS</b></p> <p>Two layers 1" x 24" proprietary type X gypsum panels inserted between floor and ceiling runners with steel H stud between adjacent pairs of gypsum panels. <b>(NLB)</b></p> <p>A 3/4" minimum air space must be maintained between steel components and adjacent framing (as indicated by dashed lines in sketch).</p> <p>Sound tested with 2 x 4 stud wall faced with 1/2" regular gypsum wallboard each side of assembly and 3 1/2" glass fiber in stud space on both sides.</p> <p style="text-align: center;"><b>PROPRIETARY GYPSUM BOARD</b></p> <p>CertainTeed Gypsum Inc.          -          1" ProRoc® Shaftliner Type X Gypsum Panels</p>			<p>Thickness: 3 1/2" (Fire) 1 1 3/4" (Sound)</p> <p>Approx. Weight: 9.5 psf</p> <p>Fire Test: UL R8701, 99NK43912, 6-1-00, UL Design U366</p> <p>Sound Test: RAL TL00-176, 12-6-00</p>
<p style="text-align: center;"><b>GYPSUM WALLBOARD, STEEL H STUDS</b></p> <p>Two layers 1" x 24" proprietary type X gypsum panels inserted between 2" floor and ceiling runners with 2" steel H studs between adjacent pairs of gypsum panels. <b>(NLB)</b></p> <p>A 3/4" minimum air space must be maintained between steel components and adjacent framing (indicated by dashed lines in sketch).</p> <p>Sound tested with 2 x 4 stud wall faced with 1/2" regular gypsum wallboard each side of system and 3 1/2" glass fiber insulation in stud space on both sides.</p> <p style="text-align: center;"><b>PROPRIETARY GYPSUM BOARD</b></p> <p>American Gypsum Company LLC          -          1" Shaft Liner Temple-Inland                                -          1" Silent Guard Gypsum Liner Board</p>			<p>Thickness: 3 1/2" (Fire) 1 1 3/4" (Sound)</p> <p>Approx. Weight: 9.5 psf</p> <p>Fire Test: UL R6937 (R14196), 04NK19014, 10-28-04, UL Design U375</p> <p>Sound Test: RAL TL05-149, 7-13-05</p>
<p style="text-align: center;"><b>GYPSUM PANEL PRODUCTS, STEEL H STUDS</b></p> <p>Two layers 1" x 24" proprietary type X gypsum panels inserted between 2" floor and ceiling runners with 2" steel H studs between adjacent pairs of gypsum panels. <b>(NLB)</b></p> <p>A 3/4" minimum air space must be maintained between steel components and adjacent framing (indicated by dashed lines in sketch).</p> <p>Sound tested with 2 x 4 stud wall faced with 1/2" regular gypsum wallboard each side of system and 3 1/2" glass fiber insulation in stud space on both sides.</p> <p style="text-align: center;"><b>PROPRIETARY GYPSUM PANEL PRODUCT</b></p> <p>Temple-Inland                                -          1" GreenGlass Gypsum Liner Board</p>			<p>Thickness: 3 1/2" (Fire) 1 1 3/4" (Sound)</p> <p>Approx. Weight: 9.5 psf</p> <p>Fire Test: UL R6937, 08NK02787, 9-19-08, UL Design U375</p> <p>Sound Test: RAL TL05-149, 7-13-05</p>

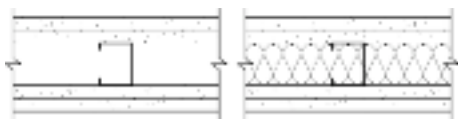
*\*Contact the manufacturer for more detailed information on proprietary products.*

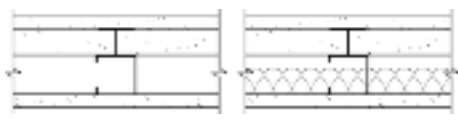

<b>AREA SEPARATION FIRE WALLS</b>				
<b>GA FILE NO. ASW 1100</b>	<b>GENERIC</b>	<b>2 HOUR FIRE</b>	<b>50 to 54 FSTC SOUND</b>	
<b>GYPSUM WALLBOARD, STEEL STUDS</b>				
<p><b>Base</b> layer 1/2" type X gypsum wallboard or gypsum veneer base applied parallel to each side of 1 5/8" steel studs 24" o.c. with 1" Type S drywall screws 12" o.c. <b>Face</b> layer 1/2" type X gypsum wallboard or gypsum veneer base applied parallel to each side with 1 5/8" Type S drywall screws 12" o.c.</p> <p>Joints staggered 24" each layer and side. Sound tested with 1 1/2" mineral fiber insulation in stud space. <b>(NLB)</b></p>				
		<p>Thickness: 3 5/8"                      Approx. Weight: 9 psf                      Fire Test: UC, 12-7-64                      Field Sound Test: ACI 1131a, 7-14-64</p>		
<b>GA FILE NO. ASW 1105</b>	<b>GENERIC</b>	<b>2 HOUR FIRE</b>	<b>50 to 54 STC SOUND</b>	
<b>GYPSUM WALLBOARD, STEEL STUDS</b>				
<p><b>Base</b> layer 1/2" type X gypsum wallboard or gypsum veneer base applied parallel to each side of 2 1/2" steel studs 24" o.c. with 1" Type S drywall screws 24" o.c. <b>Face</b> layer 1/2" type X gypsum wallboard or gypsum veneer base applied parallel to each side with 1 5/8" Type S drywall screws 12" o.c.</p> <p>Joints staggered 24" each layer and side. Sound tested with 1 1/2" mineral fiber insulation in stud space. <b>(NLB)</b></p>				
		<p>Thickness: 4 1/2"                      Approx. Weight: 9 psf                      Fire Test: UC, 9-7-64                      Sound Test: CK 654-40, 9-7-65</p>		
<b>GA FILE NO. ASW 1201</b>	<b>PROPRIETARY*</b>	<b>2 HOUR FIRE</b>	<b>45 to 49 STC SOUND</b>	
<b>GYPSUM PANEL PRODUCTS, STEEL C-H, C-T, OR I STUDS</b>				
<p>One layer 1" x 24" proprietary type X gypsum panels inserted between 2 1/2" floor and ceiling J runners with T section of 2 1/2" proprietary C-H, C-T, or I steel studs between panels. One layer 1/2" proprietary type X gypsum wallboard applied at right angles to each side with 1" Type S drywall screws 8" o.c.</p> <p>Joints staggered 24" on opposite sides. STC estimated with 1" thick glass fiber insulation stapled in stud space. <b>(NLB)</b></p>				
<b>PROPRIETARY GYPSUM PANEL PRODUCTS</b>		<p>Thickness: 3 1/2"                      Approx. Weight: 9 psf                      Fire Test: See WP 7097                      (WHI 495-1182, 5-15-92;                      WHI 495-1220, 12-17-92,                      ITS Design GP/WA 120-02)</p> <p>Sound Test: See WP 7097                      (RAL TL89-380, 11-8-89)</p>		
<p>Georgia-Pacific Gypsum LLC - 1/2" ToughRock® Fireguard C™                      - 1" DensGlass® Ultra Shaftliner™</p>				

\*Contact the manufacturer for more detailed information on proprietary products.

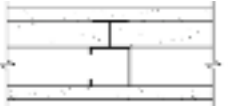
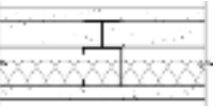
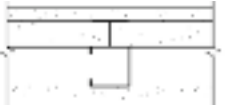
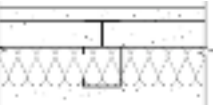
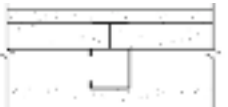
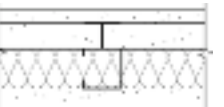
**AREA SEPARATION FIRE WALLS**

GA FILE NO. ASW 1205	PROPRIETARY*	2 HOUR FIRE	45 to 49 FSTC SOUND																								
<p align="center"><b>GYPSUM WALLBOARD, STEEL C-H STUDS</b></p> <p>One layer 1" x 24" proprietary type X gypsum panels inserted between 2 1/2" floor and ceiling J runners with H section of 2 1/2" proprietary vented C-H steel studs between panels. One layer 1/2" proprietary type X gypsum wallboard or gypsum veneer base applied to each side with 1" Type S drywall screws 12" o.c.</p> <p>Sound tested with 1" mineral fiber insulation, 3.0 pcf, in stud space. <b>(NLB)</b></p> <p align="center"><b>PROPRIETARY GYPSUM BOARD</b></p> <table border="0"> <tr> <td>American Gypsum Company LLC</td> <td>-</td> <td>1/2" FireBloc® Type C</td> </tr> <tr> <td>Lafarge North America Inc.</td> <td>-</td> <td>1/2" Firecheck® Type C</td> </tr> <tr> <td>Temple-Inland</td> <td>-</td> <td>1/2" TG-C</td> </tr> <tr> <td>United States Gypsum Company</td> <td>-</td> <td>1/2" SHEETROCK® Brand FIRECODE® C Core Gypsum Panels</td> </tr> <tr> <td></td> <td>-</td> <td>1" SHEETROCK® Brand Gypsum Liner Panels</td> </tr> </table>		American Gypsum Company LLC	-	1/2" FireBloc® Type C	Lafarge North America Inc.	-	1/2" Firecheck® Type C	Temple-Inland	-	1/2" TG-C	United States Gypsum Company	-	1/2" SHEETROCK® Brand FIRECODE® C Core Gypsum Panels		-	1" SHEETROCK® Brand Gypsum Liner Panels											
American Gypsum Company LLC	-	1/2" FireBloc® Type C																									
Lafarge North America Inc.	-	1/2" Firecheck® Type C																									
Temple-Inland	-	1/2" TG-C																									
United States Gypsum Company	-	1/2" SHEETROCK® Brand FIRECODE® C Core Gypsum Panels																									
	-	1" SHEETROCK® Brand Gypsum Liner Panels																									
<p align="center"><b>GYPSUM PANEL PRODUCTS, STEEL C-H OR C-T STUDS</b></p> <p>One layer 1" x 24" proprietary type X gypsum panels inserted between 2 1/2" floor and ceiling J runners with T section of 2 1/2" steel C-H or C-T studs between panels. One layer 1/2" proprietary type X gypsum wallboard applied parallel to each side with 1" Type S drywall screws 12" o.c.</p> <p>Sound tested with 17/8" glass fiber insulation friction fit in stud space. <b>(NLB)</b></p> <p align="center"><b>PROPRIETARY GYPSUM PANEL PRODUCTS</b></p> <table border="0"> <tr> <td>American Gypsum Company LLC</td> <td>-</td> <td>1/2" FireBloc® Type C</td> </tr> <tr> <td></td> <td>-</td> <td>1" Shaft Liner</td> </tr> <tr> <td>CertainTeed Gypsum Inc.</td> <td>-</td> <td>1/2" ProRoc® Type C Gypsum Panels</td> </tr> <tr> <td></td> <td>-</td> <td>1" GlasRoc® Shaftliner Gypsum Panels</td> </tr> <tr> <td>PABCO Gypsum</td> <td>-</td> <td>1/2" FLAME CURB® Super 'C'™</td> </tr> <tr> <td></td> <td>-</td> <td>1" PABCORE® Gypsum Liner Board</td> </tr> <tr> <td>Temple-Inland</td> <td>-</td> <td>1/2" TG-C</td> </tr> <tr> <td></td> <td>-</td> <td>1" Silent Guard™ Gypsum Liner Board</td> </tr> </table>		American Gypsum Company LLC	-	1/2" FireBloc® Type C		-	1" Shaft Liner	CertainTeed Gypsum Inc.	-	1/2" ProRoc® Type C Gypsum Panels		-	1" GlasRoc® Shaftliner Gypsum Panels	PABCO Gypsum	-	1/2" FLAME CURB® Super 'C'™		-	1" PABCORE® Gypsum Liner Board	Temple-Inland	-	1/2" TG-C		-	1" Silent Guard™ Gypsum Liner Board		
American Gypsum Company LLC	-	1/2" FireBloc® Type C																									
	-	1" Shaft Liner																									
CertainTeed Gypsum Inc.	-	1/2" ProRoc® Type C Gypsum Panels																									
	-	1" GlasRoc® Shaftliner Gypsum Panels																									
PABCO Gypsum	-	1/2" FLAME CURB® Super 'C'™																									
	-	1" PABCORE® Gypsum Liner Board																									
Temple-Inland	-	1/2" TG-C																									
	-	1" Silent Guard™ Gypsum Liner Board																									
<p align="center"><b>GYPSUM PANEL PRODUCTS, STEEL C-H OR C-T STUDS</b></p> <p>One layer 1" x 24" proprietary type X gypsum panels inserted between 2 1/2" floor and ceiling J runners with T section of 2 1/2" steel C-H or C-T studs between panels. One layer 1/2" proprietary type X gypsum wallboard applied parallel to each side with 1" Type S drywall screws 12" o.c.</p> <p>Sound tested with 17/8" glass fiber insulation friction fit in stud space. <b>(NLB)</b></p> <p align="center"><b>PROPRIETARY GYPSUM PANEL PRODUCTS</b></p> <table border="0"> <tr> <td>Temple-Inland</td> <td>-</td> <td>1/2" TG-C</td> </tr> <tr> <td></td> <td>-</td> <td>1" GreenGlass Gypsum Liner Panel</td> </tr> </table>		Temple-Inland	-	1/2" TG-C		-	1" GreenGlass Gypsum Liner Panel																				
Temple-Inland	-	1/2" TG-C																									
	-	1" GreenGlass Gypsum Liner Panel																									

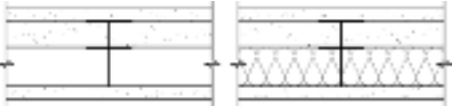
\*Contact the manufacturer for more detailed information on proprietary products.

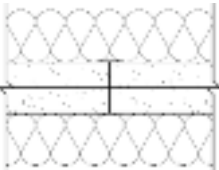

<b>AREA SEPARATION FIRE WALLS</b>				
<b>GA FILE NO. ASW 1215</b>	<b>PROPRIETARY*</b>	<b>2 HOUR FIRE</b>	<b>45 to 49 STC SOUND</b>	
<b>GYPSUM WALLBOARD, STEEL I STUDS</b>				
<p>One layer 1" x 24" proprietary type X gypsum panels inserted between 2 1/2" floor and ceiling runners with tab-flange section of 2 1/2" steel I studs between panels. One layer 1/2" proprietary type X gypsum wallboard or gypsum veneer base applied parallel or at right angles to each side with 1" Type S drywall screws 12" o.c.</p> <p>Sound tested with 1 1/2" glass fiber insulation friction fit in stud space. <b>(NLB)</b></p>				
<b>PROPRIETARY GYPSUM BOARD</b>				
National Gypsum Company	- 1/2" Gold Bond® Brand FIRE-SHIELD C™ Gypsum Board	Thickness:	3 1/2"	
	- 1" Gold Bond® Brand FIRE-SHIELD® Shaftliner	Approx. Weight:	9 psf	
		Fire Test:	UL R3501, 92NK22748, 9-15-93; 97NK4588, 1-30-97; 97NK5247, 2-4-97; UL Design U498; FM WP-545, 12-22-81	
		Sound Test:	NGC 2617, 7-27-82	
<b>GA FILE NO. ASW 1501</b>	<b>PROPRIETARY*</b>	<b>2 HOUR FIRE</b>		
<b>GYPSUM WALLBOARD, STEEL I, C-H OR C-T STUDS</b>				
<p>One layer 1" x 24" proprietary type X gypsum panels inserted between 2 1/2" floor and ceiling runners with tab-flange section of 2 1/2" steel I, C-H or C-T studs between panels. One layer 5/8" proprietary type X gypsum wallboard or gypsum veneer base applied parallel to each side with 1" Type S drywall screws 12" o.c. <b>(NLB)</b></p>				
<b>PROPRIETARY GYPSUM BOARD</b>				
American Gypsum Company LLC	- 5/8" FireBloc® Type X	Thickness:	3 1/2"	
	- 1" Shaft Liner	Approx. Weight:	9 psf	
		Fire Test:	UL R14196, 05NK29331, 2-18-06; UL R14196, 06NK09317, 4-11-06; UL Design V455	
<b>GA FILE NO. ASW 2600</b>	<b>PROPRIETARY*</b>	<b>3 HOUR FIRE</b>		
<b>GYPSUM WALLBOARD, STEEL H STUDS</b>				
<p>Two layers 1" x 24" proprietary type X gypsum panels inserted between 2" floor and ceiling runners with 2" steel H studs between adjacent pairs of gypsum panels. 2" mineral fiber insulation, 3.0 pcf, applied over each side and stapled to gypsum panels. <b>(NLB)</b></p>				
<b>PROPRIETARY GYPSUM BOARD</b>				
United States Gypsum Company	- 1" SHEETROCK® Brand Gypsum Liner Panels	Thickness:	6"	
		Approx. Weight:	9.6 psf	
		Fire Test:	WHI-495-0393, 1-14-82	

\*Contact the manufacturer for more detailed information on proprietary products.

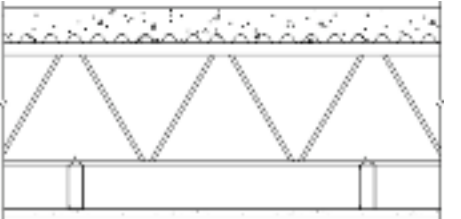
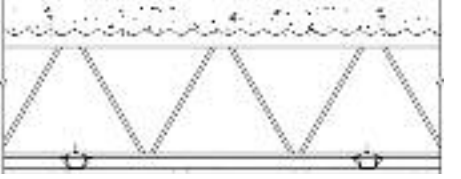
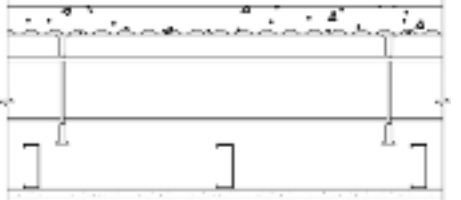
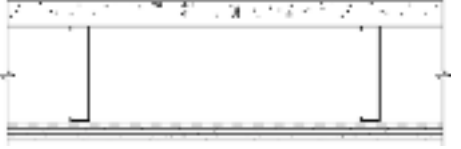

**FLOOR-CEILING SYSTEMS, NONCOMBUSTIBLE**

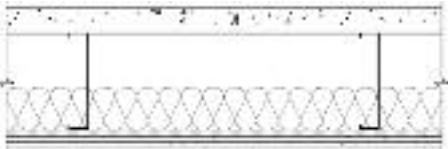
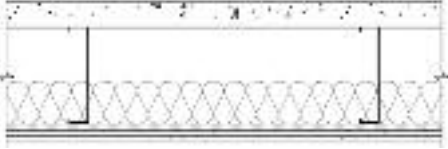
GA FILE NO. FC 1105	GENERIC	1 HOUR FIRE	50 to 54 STC SOUND
<b>GYPSUM WALLBOARD, STEEL JOISTS, CONCRETE SLAB</b>			
<p>One layer 1/2" type X gypsum wallboard or gypsum veneer base applied at right angles to 3<sup>5</sup>/<sub>8</sub>" steel studs 24" o.c. with 1" Type S drywall screws 12" o.c. Studs wire tied with double strand 18 gage wire 8' o.c. to steel joists 24" o.c. supporting 3/8" rib metal lath and 2 1/2" concrete slab. (One hour restrained and unrestrained.)</p>			
		<p>Approx. Ceiling Weight: 2 psf Fire Test: FM FC-134, 12-16-69 Sound Test: See FC 2030 (NGC 4075, 3-25-69)</p>	
GA FILE NO. FC 1110	GENERIC	1 HOUR FIRE	
<b>GYPSUM WALLBOARD, STEEL JOISTS, CONCRETE SLAB</b>			
<p>One layer 1/2" type X gypsum wallboard or gypsum veneer base applied at right angles to rigid furring channels 24" o.c. with 1" Type S drywall screws 12" o.c. in field. Gypsum board end joints located midway between continuous channels and attached to additional pieces of channel 52" long with screws 8" o.c. Furring channels wire tied to open web steel joists 24" o.c. supporting 3/8" rib metal lath or 9/16" deep 28 gage corrugated steel and 2" concrete slab measured from top of flute. (Passed 90 minute fire test restrained and unrestrained.)</p>			
		<p>Approx. Ceiling Weight: 2 psf Fire Test: UL R2717-30, 6-12-64, UL Design G502</p>	
GA FILE NO. FC 1130	GENERIC	1 HOUR FIRE	
<b>GYPSUM WALLBOARD, STEEL JOISTS, CONCRETE SLAB</b>			
<p>One layer 5/8" type X gypsum wallboard or gypsum veneer base applied at right angles to 3<sup>5</sup>/<sub>8</sub>" or 6" steel studs 16" o.c. with 1" Type S drywall screws 12" o.c. Studs placed horizontally to form ceiling envelope without direct attachment to joists except at stud ends. At end joint locations a 54" long backing stud is attached to the continuous stud with six 3/8" long self tapping screws 10" o.c. Studs with a stud sleeve on one end inserted in runners around side walls suspended by 1/8" x 1" steel straps from open web steel bar joists 24" o.c. supporting 3/8" rib metal lath and 2" concrete slab.</p>			
<p>Maximum span for 3<sup>5</sup>/<sub>8</sub>" studs is 11'10" at 16" o.c. and for 6" studs is 12'10" at 16" o.c.</p>			
		<p>Approx. Ceiling Weight: 2.5 psf Fire Test: OSU T-3694, 11-5-66</p>	
GA FILE NO. FC 1141	GENERIC	1 HOUR FIRE	
<b>GYPSUM WALLBOARD, RESILIENT CHANNELS, STEEL CHANNEL JOISTS, CONCRETE SLAB</b>			
<p><b>Base</b> layer 1/2" type X gypsum wallboard applied at right angles to resilient furring channels 24" o.c. with 1 1/4" Type S drywall screws 12" o.c. Resilient furring channels applied at right angles to channel shaped, minimum 8" deep, 18 gage galvanized steel joists 24" o.c. with 3/4" Type S-12 drywall screws at each joist. Base layer butt joints staggered 48" in adjacent courses. <b>Face</b> layer 1/2" type X gypsum wallboard applied at right angles to channels with end joints located midway between channels. Face layer attached to channels with 1 1/2" Type S drywall screws 12" o.c. End joints attached to base layer with 1 1/2" Type G screws 12" o.c. placed 1 1/2" back from either side of end joints. Face layer edge joints offset 24" from base layer edge joints. Face layer end joints offset 36" from base layer end joints. Joists supporting 5/8" deep 30 gage corrugated steel deck and 1 3/8" (measured from top of flute) concrete slab.</p>			
		<p>Approx. Ceiling Weight: 4 psf Fire Test: NRCC B-4216.1, 3-3-05, Assembly FF-40</p>	

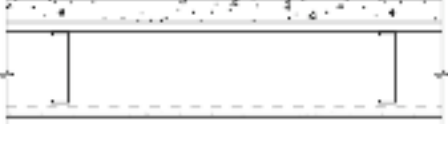

<b>FLOOR-CEILING SYSTEMS, NONCOMBUSTIBLE</b>		
<b>GA FILE NO. FC 1142</b>	<b>GENERIC</b>	<b>1 HOUR FIRE</b>
<b>GYPSUM WALLBOARD, RESILIENT CHANNELS, STEEL CHANNEL JOISTS, GLASS FIBER INSULATION, CONCRETE SLAB</b>		
<p><b>Base</b> layer 1/2" type X gypsum wallboard applied at right angles to resilient furring channels 24" o.c. with 1 1/4" Type S drywall screws 12" o.c. Resilient furring channels applied at right angles to channel shaped, minimum 8" deep, 18 gage galvanized steel joists 16" o.c. with 3/4" Type S-12 drywall screws at each joist. Base layer butt joints staggered 48" in adjacent courses. <b>Face</b> layer 1/2" type X gypsum wallboard applied at right angles to channels with end joints located midway between channels. Face layer attached to channels with 1 1/2" Type S drywall screws 12" o.c. End joints attached to base layer with 1 1/2" Type G screws 12" o.c. placed 1 1/2" back from either side of end joints. Face layer edge joints offset 24" from base layer edge joints. Face layer end joints offset 36" from base layer end joints. Joists supporting 5/8" deep 30 gage corrugated steel deck and 1 3/8" (measured from top of flute) concrete slab. 3 1/2" glass fiber batt insulation, 0.64 pcf, in joist space.</p>		
<p>Approx. Ceiling Weight: 4 psf Fire Test: NRCC B-4216.1, 3-3-05, Assembly FF-43</p>		
<b>GA FILE NO. FC 1143</b>	<b>GENERIC</b>	<b>1 HOUR FIRE</b>
<b>GYPSUM WALLBOARD, RESILIENT CHANNELS, STEEL CHANNEL JOISTS, MINERAL FIBER INSULATION, CONCRETE SLAB</b>		
<p><b>Base</b> layer 1/2" type X gypsum wallboard applied at right angles to resilient furring channels 24" o.c. with 1 1/4" Type S drywall screws 12" o.c. Resilient furring channels applied at right angles to channel shaped, minimum 8" deep, 18 gage galvanized steel joists 16" o.c. with 3/4" Type S-12 drywall screws at each joist. Base layer butt joints staggered 48" in adjacent courses. <b>Face</b> layer 1/2" type X gypsum wallboard applied at right angles to channels with end joints located midway between channels. Face layer attached to channels with 1 1/2" Type S drywall screws 12" o.c. End joints attached to base layer with 1 1/2" Type G screws 12" o.c. placed 1 1/2" back from either side of end joints. Face layer edge joints offset 24" from base layer edge joints. Face layer end joints offset 36" from base layer end joints. Joists supporting 5/8" deep 30 gage corrugated steel deck and 1 3/8" (measured from top of flute) concrete slab. 3 1/2" glass fiber insulation, 0.64 pcf, or 3 1/2" mineral fiber batt insulation, 2.2 pcf, in joist space.</p>		
<p>Approx. Ceiling Weight: 4 psf Fire Test: NRCC B-4216.1, 3-3-05, Assemblies FF-44 &amp; FF-53</p>		
<b>GA FILE NO. FC 1144</b>	<b>GENERIC</b>	<b>1 HOUR FIRE</b>
<b>GYPSUM WALLBOARD, STEEL CHANNEL JOISTS, CONCRETE SLAB</b>		
<p><b>Base</b> layer 1/2" type X gypsum wallboard applied at right angles to channel shaped, minimum 8" deep, 18 gage galvanized steel joists 24" o.c. with 1 1/4" Type S-12 drywall screws 12" o.c. Base layer butt joints staggered 48" in adjacent courses. <b>Face</b> layer 1/2" type X gypsum wallboard applied at right angles to joists with end joints located midway between joists. Face layer attached to joists with 1 1/2" Type S-12 drywall screws 12" o.c. End joints attached to base layer with 1 1/2" Type G screws 12" o.c. placed 1 1/2" back from either side of end joints. Face layer edge joints offset 24" from base layer edge joints. Face layer end joints offset 36" from base layer end joints. Joists supporting 5/8" deep 30 gage corrugated steel deck and 1 3/8" (measured from top of flute) concrete slab.</p>		
<p>Approx. Ceiling Weight: 4 psf Fire Test: NRCC B-4216.1, 3-3-05, Assembly FF-54</p>		
<b>GA FILE NO. FC 1145</b>	<b>GENERIC</b>	<b>1 HOUR FIRE</b>
<b>GYPSUM WALLBOARD, RESILIENT CHANNELS, STEEL JOISTS, CONCRETE SLAB</b>		
<p>One layer 1/2" type X gypsum wallboard or gypsum veneer base applied at right angles to resilient furring channels 24" o.c. with 1" Type S drywall screws 12" o.c. set back 2" from edges. Gypsum board end joints located midway between continuous channels and attached to additional pieces of channel 60" long with screws 12" o.c. Furring channels applied at right angles to 6" x 1 5/8" flanged 18 gage steel channel joists 24" o.c. with two 3/8" Type S-12 drywall screws at each joist. Joists supporting 25 gage corrugated metal deck and 2" (measured from top of flute) light weight, 105 pcf, concrete slab. (One hour unrestrained.)</p>		
<p>Approx. Ceiling Weight: 2 psf Fire Test: FM FC 245-1, 1-27-77</p>		

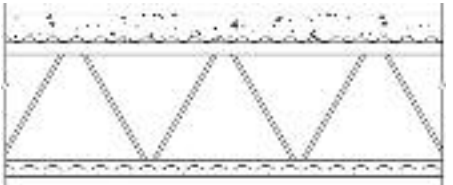
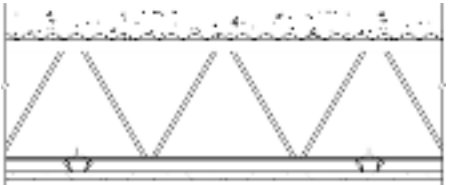
**FLOOR-CEILING SYSTEMS, NONCOMBUSTIBLE**

<p><b>GA FILE NO. FC 1146</b></p>	<p><b>PROPRIETARY*</b></p>	<p><b>1 HOUR FIRE</b></p>
<p><b>GYPSUM WALLBOARD, RESILIENT CHANNELS, STEEL CHANNEL JOISTS, GLASS FIBER INSULATION, CONCRETE SLAB</b></p>		
<p>One layer 5/8" proprietary type X gypsum wallboard or gypsum veneer base applied at right angles to resilient furring channels 12" o.c. with 1" Type S drywall screws 8" o.c. fastened 1 1/2" from edges. Resilient furring channels applied at right angles to channel shaped, minimum 9 1/4" deep, 16 gage galvanized steel joists 24" o.c. with 1/2" Type S-12 drywall screws at each joist. Gypsum board end joints located midway between continuous channels and attached to additional pieces of channel with screws 8" o.c. Joists supporting 9/16" deep 22 gage corrugated steel deck and 1" (measured from top of flute) proprietary gypsum floor topping. 3 1/2" mineral wool or glass fiber insulation batts draped over channels.</p>		<p>Approx. Ceiling Weight: 3 psf Fire Test: R3660, 07NK25172, 7-9-08, UL Design G568</p>
<p><b>PROPRIETARY GYPSUM BOARD</b> CertainTeed Gypsum Inc. - 5/8" ProRoc® Type C Gypsum Panel</p>		
<p><b>GA FILE NO. FC 1180</b></p>	<p><b>GENERIC</b></p>	<p><b>1 HOUR FIRE</b></p>
<p><b>STEEL JOISTS, CONCRETE SLAB, METAL LATH, GYPSUM PLASTER</b></p>		
<p>5/8" 1:2-1:3 gypsum-sand plaster applied over 3/8" rib metal lath wire tied with 18 gage wire 5" o.c. to open web steel joists 24" o.c. supporting 3/8" rib metal lath and 2" concrete slab. (Passed 90 minute fire test.)</p>		<p>Approx. Ceiling Weight: 4 psf Fire Test: BMS 92/43, 10-7-42</p>
<p><b>GA FILE NO. FC 1181</b></p>	<p><b>PROPRIETARY*</b></p>	<p><b>1 HOUR FIRE</b></p>
<p><b>STEEL JOISTS, CONCRETE SLAB, GLASS MAT GYPSUM SUBSTRATE</b></p>		
<p>One layer 5/8" proprietary type X glass mat gypsum substrate applied at right angles to rigid furring channels 24" o.c. with 1" Type S drywall screws 12" o.c. Gypsum panel end joints located midway between continuous channels and attached to additional pieces of channel 60" long with screws 12" o.c. Furring channels attached with 18 gage wire ties to open web steel joists 24" o.c. supporting 3/8" rib metal lath and 2" concrete slab.</p>		<p>Approx. Ceiling Weight: 2.5 psf Fire Test: UL R3660/R15187, 2-4-02, UL Design G501</p>
<p><b>PROPRIETARY GYPSUM PANEL PRODUCT</b> CertainTeed Gypsum Inc. - 5/8" GlasRoc® Sheathing Type X Gypsum Panels</p>		

*\*Contact the manufacturer for more detailed information on proprietary products.*

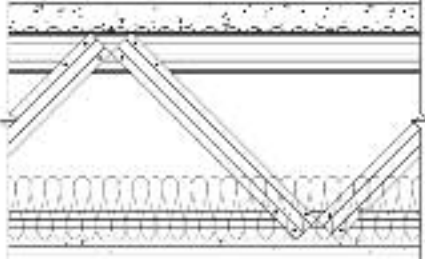
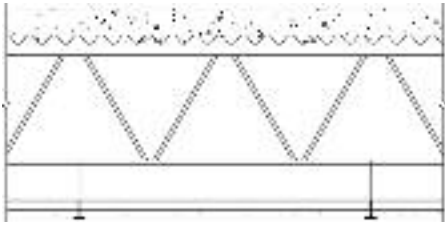
## FLOOR-CEILING SYSTEMS, NONCOMBUSTIBLE

GA FILE NO. FC 1190	PROPRIETARY*	1 HOUR FIRE	
<p><b>STEEL TRUSSES, RESILIENT CHANNELS, MINERAL OR GLASS FIBER INSULATION, GYPSUM WALLBOARD, CONCRETE SLAB</b></p> <p>One layer 5/8" proprietary type X gypsum wallboard applied at right angles to resilient furring channels with 1" Type S drywall screws 12" o.c. Resilient channels spaced 12" o.c. when insulation is used or 16" o.c. when no insulation is used. Gypsum board end joints attached with screws 12" o.c. to additional pieces of channel 60" long located 3" back on either side of end joint. Resilient channels applied at right angles to bottom chord of light-gage steel trusses 48" o.c. with 1/2" Type S-12 screws (<b>refer to furring channel manufacturer for maximum spans</b>). Optional glass fiber or mineral fiber batt or loose fill insulation applied directly over gypsum board. Trusses supporting 3/8" rib metal lath and 2" normal weight or lightweight concrete slab.</p> <p style="text-align: center;"><b>PROPRIETARY GYPSUM BOARD</b></p> <p>American Gypsum Company LLC - 5/8" FireBloc® Type C Temple-Inland - 5/8" TG-C</p>			<p>Approx. Ceiling Weight: 3 psf Fire Test: UL R14196, 07NK19575, 2-15-08, UL Design G567</p>
<p><b>GA FILE NO. FC 1290</b></p> <p style="text-align: center;"><b>PROPRIETARY*</b></p> <p style="text-align: center;"><b>STEEL JOISTS, CONCRETE SLAB, METAL LATH, GYPSUM TILES</b></p> <p>Nominal 24" x 48" x 1/2" proprietary type X gypsum wallboard lay-in panels supported by steel suspension system suspended from steel open web joists supporting 3/8" rib metal lath and 2 1/2" concrete slab. (1 1/2 hour restrained and unrestrained.)</p> <p style="text-align: center;"><b>PROPRIETARY GYPSUM BOARD</b></p> <p>National Gypsum Company - 1/2" Gridstone® Brand Ceiling Panels</p>			<p style="text-align: center;"><b>1 1/2 HOUR FIRE</b></p> <p>Approx. Ceiling Weight: 2.5 psf Fire Test: FM J.I. 0F6Q7.AC, 7-17-80, FM FC-300</p>
<p><b>GA FILE NO. FC 1800</b></p> <p style="text-align: center;"><b>PROPRIETARY*</b></p> <p style="text-align: center;"><b>GYPSUM WALLBOARD, RESILIENT CHANNELS, STEEL CHANNEL JOISTS, STRUCTURAL CEMENT PANELS, GYPSUM FLOOR UNDERLAYMENT</b></p> <p>One layer 5/8" proprietary type X gypsum wallboard applied parallel to resilient furring channels 12" o.c. with 1" Type S drywall screws 8" o.c. in the field and 8" o.c. at the perimeter edges along the resilient channel spaced 3" from the wallboard edge on either side. Resilient channels are attached to 16 gage 10" deep steel channel joists spaced 16" o.c. Joists supporting 3/4" proprietary structural cement-fiber units applied at right angles to joists with No. 8 x 1 5/8" self drilling screws spaced 8" o.c. at butt joints and 12" o.c. in the field. 1/2" proprietary gypsum floor topping applied over fiber-cement panels. 3 5/8" mineral or glass fiber insulation in floor cavity.</p> <p style="text-align: center;"><b>PROPRIETARY GYPSUM BOARD</b></p> <p>United States Gypsum Company - 5/8" SHEETROCK® Brand FIRECODE® C Core Gypsum Panels</p>			<div style="display: flex; justify-content: space-between;"> <div style="width: 45%;"> <p style="text-align: center;"><b>2 HOUR FIRE</b></p> <p>Approx. Ceiling Weight: 2.5 psf Fire Test: UL R25352, 05CA34168, 8-15-06, UL Design G556</p> <p>Sound Test: USG 060802, 8-11-06; USG 060803, 8-28-06</p> <p>IIC &amp; Test: (43 ceramic tile) USG 060802, 8-11-06; (46 ceramic tile over membrane) USG 060803, 8-28-06</p> </div> <div style="width: 45%; text-align: center;"> <p><b>60 to 64 STC SOUND</b></p> </div> </div>

*\*Contact the manufacturer for more detailed information on proprietary products.*

**FLOOR-CEILING SYSTEMS, NONCOMBUSTIBLE**

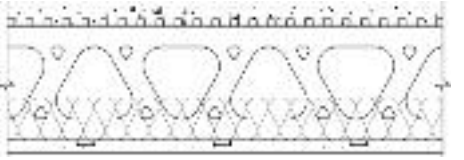
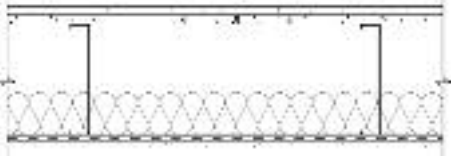
GA FILE NO. FC 1900	PROPRIETARY*	2 HOUR FIRE	55 to 59 STC SOUND
<p align="center"><b>GYPSUM WALLBOARD, RESILIENT CHANNELS, PROPRIETARY STEEL FLOOR JOISTS, GLASS OR MINERAL FIBER INSULATION, GYPSUM FLOOR UNDERLAYMENT</b></p>			
<p>One layer 5/8" proprietary type X gypsum wallboard applied at right angles to resilient furring channels 12" o.c. with 1" Type S drywall screws 8" o.c. Gypsum board end joints located midway between continuous channels and attached to additional pieces of channel with screws at 8" o.c. Resilient channels applied at right angles to bottom chord of 9 1/4" deep, 16 gage galvanized proprietary light-gage steel floor joists spaced a maximum of 24" o.c. with 3/4" type S-12 screws. Optional glass fiber applied directly over gypsum board. Floor joists supporting 9/16" 22 gage corrugated fluted steel deck. 1" proprietary gypsum floor topping applied over steel deck.</p>		<p>Approx. Ceiling Weight: 3 psf                      Fire Test: UL R3501, 06NK28969, 5-16-07, UL Design G563                      Sound Test: NGC 5008018, 5-20-08</p>	
<p align="center"><b>PROPRIETARY GYPSUM BOARD</b>                      National Gypsum Company - 5/8" Gold Bond® Brand FIRE-SHIELD C™ Gypsum Board</p>			
GA FILE NO. FC 1901	PROPRIETARY*	2 HOUR FIRE	55 to 59 STC SOUND
<p align="center"><b>GYPSUM WALLBOARD, RESILIENT CHANNELS, STEEL CHANNEL JOISTS, STRUCTURAL CEMENT PANELS, GYPSUM FLOOR UNDERLAYMENT</b></p>			
<p>One layer 5/8" proprietary type X gypsum wallboard applied parallel to resilient furring channels 12" o.c. with 1" Type S drywall screws 8" o.c. in the field and 8" o.c. at the perimeter edges along the resilient channel spaced 3" from the wallboard edge on either side. Gypsum board end joints located midway between continuous channels and attached to additional pieces of channel with screws at 8" o.c. Resilient channels are attached to 16 gage, 9 1/4" deep steel channel joists spaced 24" o.c. Joists supporting 3/4" proprietary structural cement-fiber units applied at right angles to joists with No. 8 x 1 5/8" self drilling screws spaced 8" o.c. at butt joints and 12" o.c. in the field. 3/4" proprietary gypsum floor topping applied over fiber-cement panels. 3 5/8" mineral or glass fiber insulation in floor cavity.</p>		<p>Approx. Ceiling Weight: 2.5 psf                      Fire Test: UL R25352, 05CA34168, 8-15-06, UL Design G535                      Sound Test: RAL TL06-159, 5-4-06; RAL TL06-165, 5-9-06; RAL TL06-166, 5-10-06; RAL TL06-167, 5-11-06; RAL TL06-186, 5-26-06                      IIC &amp; Test: (65 C&amp;P) RAL IN06-006, 5-4-06; (62 C&amp;P with Drywall Suspension System Instead of Resilient Channel) RAL IN06-007, 5-9-06; (48 Engineered Wood with Drywall Suspension System Instead of Resilient Channel) RAL IN06-008, 5-10-06; (36 Bare Floor with Drywall Suspension System Instead of Resilient Channel) RAL IN06-009, 5-11-06; (52 Ceramic Tile over Mat with Drywall Suspension System Instead of Resilient Channel) RAL IN06-010, 5-26-06</p>	
<p align="center"><b>PROPRIETARY GYPSUM COMPONENTS</b>                      United States Gypsum Company - 5/8" SHEETROCK® Brand FIRECODE® C Core Gypsum Panels                      - LEVELROCK® Brand Floor Underlayment</p>			

*\*Contact the manufacturer for more detailed information on proprietary products.*

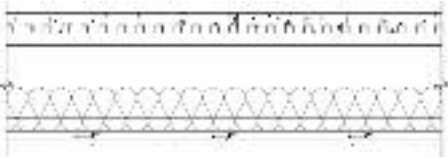
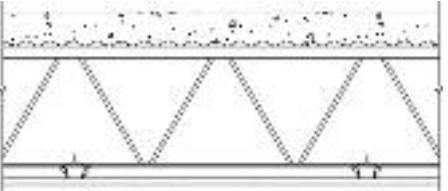
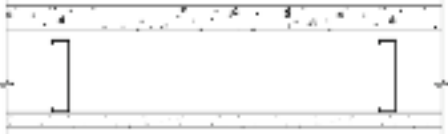
<b>FLOOR-CEILING SYSTEMS, NONCOMBUSTIBLE</b>			
<b>GA FILE NO. FC 1902</b>	<b>PROPRIETARY*</b>	<b>2 HOUR FIRE</b>	<b>55 to 59 STC SOUND</b>
<p style="text-align: center;"><b>GYPSUM WALLBOARD, RESILIENT CHANNELS, GLASS FIBER INSULATION, STEEL CHANNEL JOISTS, METAL DECK, GYPSUM FLOOR UNDERLAYMENT</b></p> <p>One layer 5/8" proprietary type X gypsum wallboard applied at right angles to resilient furring channels 12" o.c. with 1" Type S drywall screws 8" o.c. in the field and 8" o.c. at the perimeter edges along the resilient channel spaced 3" from the wallboard edge on either side. Gypsum board end joints located midway between continuous channels and attached to additional pieces of channel with screws at 8" o.c. Resilient channels are attached to 16 gage, 8" deep steel channel joists spaced 24" o.c. Joists supporting 22 guage, 9/16" corrugated metal deck. 1" proprietary gypsum floor topping applied over metal deck. 3 1/2" glass fiber insulation in floor cavity.</p> <p style="text-align: center;"><b>PROPRIETARY GYPSUM COMPONENTS</b></p> <p>United States Gypsum Company      - 5/8" SHEETROCK® Brand FIRECODE® C Core Gypsum Panels                      - LEVELROCK® Brand Floor Underlayment</p>			
		<p>Approx. Ceiling Weight: 2.5 psf                      Fire Test: UL R25211, 06CA24681, 10-13-06, UL Design G559                      Sound Test: RAL TL07-132, 5-22-07; RAL TL07-133, 5-23-07; RAL TL07-134, 5-23-07; RAL TL07-138, 5-29-07 (85 C&amp;P)                      IIC &amp; Test: RAL IN07-005, 5-22-07; (54 Vinyl) RAL IN07-007, 5-23-07; (59 Laminate Floor) RAL IN07-008, 5-29-07; (36 Bare Floor) RAL IN07-005, 5-22-07</p>	
<b>GA FILE NO. FC 2030</b>	<b>GENERIC</b>	<b>2 HOUR FIRE</b>	<b>50 to 54 STC SOUND</b>
<p style="text-align: center;"><b>STEEL JOISTS, CONCRETE SLAB, GYPSUM WALLBOARD</b></p> <p>One layer 1/2" type X gypsum wallboard or gypsum veneer base applied at right angles to rigid furring channels 24" o.c. with 1" Type S drywall screws 12" o.c. Gypsum board end joints located midway between continuous channels and attached to additional pieces of channel 54" long with screws 12" o.c. Furring channels attached with 18 gage wire ties 48" o.c. to open web steel joists 24" o.c. supporting 3/8" rib metal lath or 9/16" deep 28 gage corrugated steel and 2 1/2" concrete slab measured from top of flute. Furring channels may be attached to 1 1/2" cold rolled carrying channels 48" o.c. suspended from joists by 8 gage wire hangers not over 48" o.c. <b>(Two hour restrained and unrestrained.)</b></p> <p>(See GA File No. BM 3310)</p>			
		<p>Approx. Ceiling Weight: 2 psf                      Fire Test: UL R3501-28, 2-7-64, UL Design G514; ULC Design I511                      Sound Test: NGC 4075, 3-25-69</p>	
<b>GA FILE NO. FC 2116</b>	<b>GENERIC</b>	<b>2 HOUR FIRE</b>	
<p style="text-align: center;"><b>GYPSUM WALLBOARD, STEEL CHANNEL JOIST, CONCRETE SLAB</b></p> <p><b>Base</b> layer 5/8" type X gypsum wallboard or veneer base applied at right angles to channel shaped, minimum 7 1/4" deep, 18 gage galvanized steel joists 24" o.c. with 1" Type S-12 drywall screws 12" o.c. End joints located midway between joists and staggered between rows. <b>Face</b> layer 5/8" type X gypsum wallboard or veneer base applied at right angles to joists with 17/8" Type S-12 drywall screws 12" o.c. placed 2" from edges and 1 1/2" Type G drywall screws 12" o.c. placed 2" back on either side of end joints. End joints located midway between joists and all joints offset 24" from base layer joints.</p> <p>Joists supporting 28 gage corrugated metal deck and 2 1/2" concrete slab measured from the bottom of flutes. Joists braced at midspan with continuous 2" wide, 18 gage, galvanized steel straps attached to the bottom flange of each joist with one 3/8" Type S-12 panhead screw.</p>			
		<p>Approx. Ceiling Weight: 5 psf                      Fire Test: FM FC 224-2, 9-19-75</p>	

\*Contact the manufacturer for more detailed information on proprietary products.

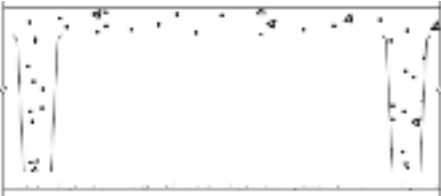
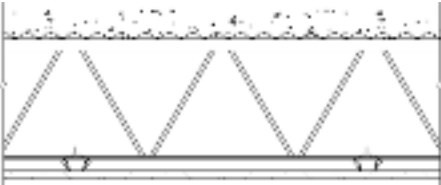
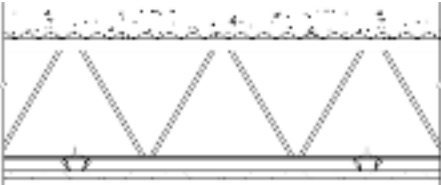
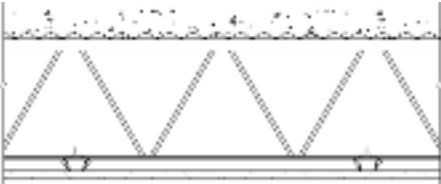
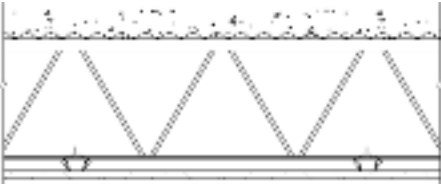
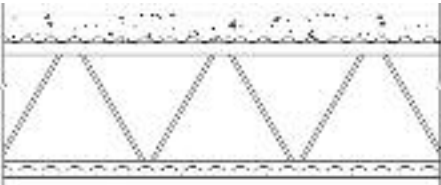
<b>FLOOR-CEILING SYSTEMS, NONCOMBUSTIBLE</b>			
<b>GA FILE NO. FC 2120</b>	<b>GENERIC</b>	<b>2 HOUR FIRE</b>	
<b>CONCRETE SLAB, PAN JOISTS, GYPSUM WALLBOARD</b>			
<p>One layer 5/8" type X gypsum wallboard or gypsum veneer base applied at right angles to rigid furring channels 24" o.c. with 1" Type S drywall screws 8 o.c. Gypsum board end joints located over continuous channels and attached to additional pieces of channel 54" long located midway between continuous channels at end joints. Furring channels 24" o.c. suspended from 2 1/2" precast reinforced concrete joists 35" o.c. with 21 gage galvanized steel hanger straps fastened to sides of joists. Joist leg depth, 10".</p>			<p>Approx. Ceiling Weight: 3 psf Fire Test: PCA 1281-1, 10-67</p>
<b>GA FILE NO. FC 2130</b>	<b>PROPRIETARY*</b>	<b>2 HOUR FIRE</b>	
<b>STEEL JOISTS, CONCRETE SLAB, GYPSUM WALLBOARD</b>			
<p>One layer 5/8" proprietary type X gypsum wallboard or gypsum veneer base applied at right angles to rigid furring channels 24" o.c. with 1" Type S drywall screws 12" o.c. Gypsum board end joints located midway between continuous channels and attached to additional pieces of channel 62" long with screws 12" o.c. Furring channels attached with 18 gage wire ties to open web steel joists 24" o.c. supporting 3/8" rib metal lath and 2" concrete slab. (Two hours restrained and unrestrained.)</p>			
<b>PROPRIETARY GYPSUM BOARD</b>			
<p>American Gypsum Company LLC - 5/8" FireBloc® TYPE X                  CertainTeed Gypsum Inc. - 5/8" ProRoc® Type C Gypsum Panels                  Georgia-Pacific Gypsum LLC - 5/8" ToughRock® Fireguard C™                  Lafarge North America Inc. - 5/8" Firecheck® Type C                  National Gypsum Company - 5/8" Gold Bond® Brand FIRE-SHIELD C™ Gypsum Board                  PABCO Gypsum - 5/8" FLAME CURB® Type X                  Temple-Inland - 5/8" Type X</p>			<p>Approx. Ceiling Weight: 2.5 psf Fire Test: UL R2717-43, 7-29-66, UL Design G505; ULC Design I512</p>
<b>GA FILE NO. FC 2131</b>	<b>PROPRIETARY*</b>	<b>2 HOUR FIRE</b>	
<b>STEEL JOISTS, CONCRETE SLAB, GLASS MAT GYPSUM SUBSTRATE</b>			
<p>One layer 5/8" proprietary type X glass mat gypsum substrate applied at right angles to rigid furring channels 24" o.c. with 1" Type S drywall screws 12" o.c. Gypsum panel end joints located midway between continuous channels and attached to additional pieces of channel 62" long with screws 12" o.c. Furring channels attached with 18 gage wire ties to open web steel joists 24" o.c. supporting 3/8" rib metal lath and 2" concrete slab. (Two hours restrained and unrestrained.)</p>			
<b>PROPRIETARY GYPSUM PANEL PRODUCTS</b>			
<p>Temple-Inland - 5/8" GreenGlass Type X</p>			<p>Approx. Ceiling Weight: 2.5 psf Fire Test: UL R6937, 08NK02787, 9-19-08, UL Design G505</p>
<b>GA FILE NO. FC 2160</b>	<b>GENERIC</b>	<b>2 HOUR FIRE</b>	
<b>STEEL JOISTS, CONCRETE SLAB, METAL LATH, GYPSUM PLASTER</b>			
<p>5/8" gypsum-vermiculite plaster or 7/8" gypsum-wood fiber plaster applied over 3/8" rib metal lath wire tied with 18 gage wire 5" o.c. to open web steel joists 24" o.c. supporting 3/8" rib metal lath and 2" concrete slab.</p>			<p>Approx. Ceiling Weight: 3 psf Fire Test: BMS 92-43, 10-7-42</p>

*\*Contact the manufacturer for more detailed information on proprietary products.*

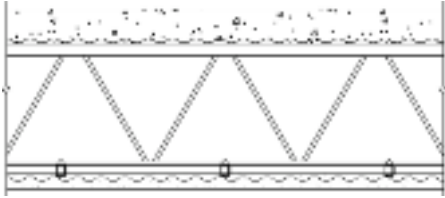
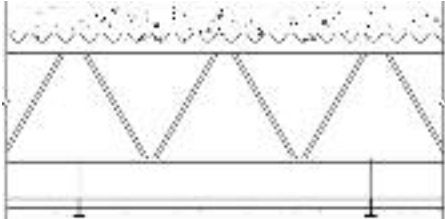
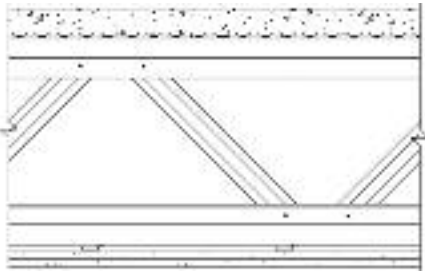

<b>FLOOR-CEILING SYSTEMS, NONCOMBUSTIBLE</b>																				
<b>GA FILE NO. FC 2170</b>	<b>GENERIC</b>	<b>2 HOUR FIRE</b>																		
<p style="text-align: center;"><b>STEEL JOISTS, CONCRETE SLAB, METAL LATH, GYPSUM PLASTER</b></p> <p><math>\frac{3}{4}</math>" 1:1 gypsum-sand wood-fibered plaster applied over 3.4 lb. metal lath wire tied 6" o.c. with 18 gage wire 6" o.c. to <math>\frac{3}{4}</math>" cold rolled channels 13<math>\frac{1}{2}</math>" o.c. Channels wire tied with 18 gage wire to open web steel joists 24" o.c. supporting <math>\frac{3}{8}</math>" rib metal lath and 2<math>\frac{1}{2}</math>" concrete slab.</p>																				
		<p>Approx. Ceiling Weight: 4 psf Fire Test: UL R5429-1, 9-23-66</p>																		
<b>GA FILE NO. FC 2190</b>	<b>PROPRIETARY*</b>	<b>2 HOUR FIRE</b>																		
<p style="text-align: center;"><b>STEEL JOISTS, CONCRETE SLAB, METAL LATH, GYPSUM TILES</b></p> <p>Nominal 24" x 24" x <math>\frac{1}{2}</math>" proprietary type X gypsum wallboard lay-in panels supported by steel suspension system suspended from steel open web joists supporting <math>\frac{3}{8}</math>" rib metal lath and 2<math>\frac{1}{2}</math>" concrete slab. (Two hour restrained and unrestrained.)</p> <p style="text-align: center;"><b>PROPRIETARY GYPSUM BOARD</b></p> <table border="0"> <tr> <td>American Gypsum Company LLC</td> <td>-</td> <td><math>\frac{1}{2}</math>" FireBloc® Type C</td> </tr> <tr> <td>CertainTeed Gypsum Inc.</td> <td>-</td> <td><math>\frac{1}{2}</math>" ProRoc® Type C Gypsum Panels</td> </tr> <tr> <td>Lafarge North America Inc.</td> <td>-</td> <td><math>\frac{1}{2}</math>" Firecheck® Type C</td> </tr> <tr> <td>National Gypsum Company</td> <td>-</td> <td><math>\frac{1}{2}</math>" Gridstone® Brand Ceiling Panels</td> </tr> <tr> <td>Temple-Inland</td> <td>-</td> <td><math>\frac{1}{2}</math>" TG-C</td> </tr> <tr> <td>United States Gypsum Company</td> <td>-</td> <td><math>\frac{1}{2}</math>" SHEETROCK® Brand ClimaPlus™ Gypsum Lay-In Panels</td> </tr> </table>		American Gypsum Company LLC	-	$\frac{1}{2}$ " FireBloc® Type C	CertainTeed Gypsum Inc.	-	$\frac{1}{2}$ " ProRoc® Type C Gypsum Panels	Lafarge North America Inc.	-	$\frac{1}{2}$ " Firecheck® Type C	National Gypsum Company	-	$\frac{1}{2}$ " Gridstone® Brand Ceiling Panels	Temple-Inland	-	$\frac{1}{2}$ " TG-C	United States Gypsum Company	-	$\frac{1}{2}$ " SHEETROCK® Brand ClimaPlus™ Gypsum Lay-In Panels	
American Gypsum Company LLC	-	$\frac{1}{2}$ " FireBloc® Type C																		
CertainTeed Gypsum Inc.	-	$\frac{1}{2}$ " ProRoc® Type C Gypsum Panels																		
Lafarge North America Inc.	-	$\frac{1}{2}$ " Firecheck® Type C																		
National Gypsum Company	-	$\frac{1}{2}$ " Gridstone® Brand Ceiling Panels																		
Temple-Inland	-	$\frac{1}{2}$ " TG-C																		
United States Gypsum Company	-	$\frac{1}{2}$ " SHEETROCK® Brand ClimaPlus™ Gypsum Lay-In Panels																		
		<p>Approx. Ceiling Weight: 2.5 psf Fire Test: UL R1319-126, 6-16-70; UL R3501, 92NK28896, 9-15-93; UL Design G222</p>																		
<b>GA FILE NO. FC 2191</b>	<b>PROPRIETARY*</b>	<b>2 HOUR FIRE</b>																		
<p style="text-align: center;"><b>STEEL TRUSSES, CONCRETE SLAB, RESILIENT CHANNELS, GYPSUM WALLBOARD</b></p> <p><b>Base</b> layer <math>\frac{5}{8}</math>" proprietary type X gypsum wallboard applied at right angles to resilient or rigid furring channels spaced 16" o.c. with <math>\frac{11}{8}</math>" Type S drywall screws 12" o.c. Gypsum board end joints attached with screws 12" o.c. to additional pieces of channel 60" long located 3" back on either side of end joint. <b>Face</b> layer <math>\frac{5}{8}</math>" proprietary type X gypsum wallboard applied at right angles to channels with <math>\frac{15}{8}</math>" Type S drywall screws 12" o.c. Face layer joints offset not less than 16" from base layer joints. Channels applied at right angles to bottom chord of light-gage steel trusses 48" o.c. with <math>\frac{1}{2}</math>" Type S-12 screws (<b>refer to furring channel manufacturer for maximum spans</b>). Trusses supporting <math>\frac{3}{8}</math>" rib metal lath and 2" normal or lightweight concrete slab.</p> <p style="text-align: center;"><b>PROPRIETARY GYPSUM BOARD</b></p> <table border="0"> <tr> <td>American Gypsum Company LLC</td> <td>-</td> <td><math>\frac{5}{8}</math>" FireBloc® Type C</td> </tr> <tr> <td>Temple-Inland</td> <td>-</td> <td><math>\frac{5}{8}</math>" TG-C</td> </tr> </table>		American Gypsum Company LLC	-	$\frac{5}{8}$ " FireBloc® Type C	Temple-Inland	-	$\frac{5}{8}$ " TG-C													
American Gypsum Company LLC	-	$\frac{5}{8}$ " FireBloc® Type C																		
Temple-Inland	-	$\frac{5}{8}$ " TG-C																		
		<p>Approx. Ceiling Weight: 5 psf Fire Test: UL R14196, 07NK19575, 2-15-08; UL R6937, 08NK02787, 9-19-08; UL Design L565</p>																		

\*Contact the manufacturer for more detailed information on proprietary products.

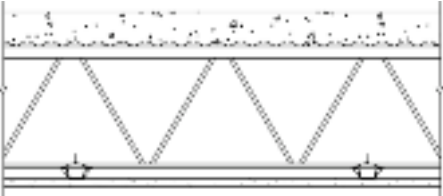
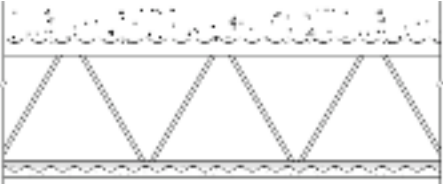
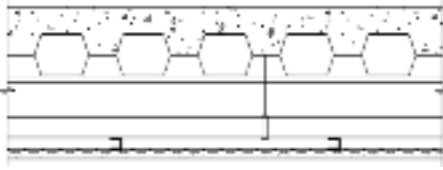
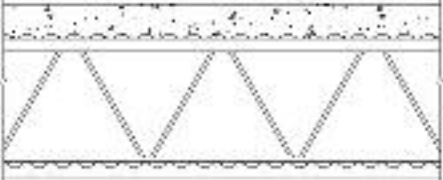

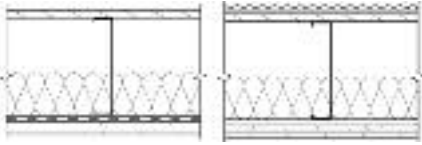
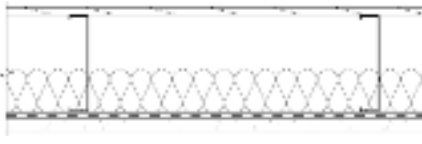

FLOOR-CEILING SYSTEMS, NONCOMBUSTIBLE																															
GA FILE NO. FC 3012	PROPRIETARY*	3 HOUR FIRE	50 to 54 STC SOUND	<p><b>STEEL JOISTS, CONCRETE SLAB, GYPSUM WALLBOARD</b></p> <p>One layer 5/8" proprietary type X gypsum wallboard or gypsum veneer base applied at right angles to furring channels 24" o.c. (double channels at end joints) with 1" Type S drywall screws 12" o.c. 5/8" x 2 3/4" type X gypsum wallboard strips over butt joints. Furring channels wire tied to open web steel joist 24" o.c. supporting 3/8" rib metal lath and 2 1/2" concrete slab. (Three hour restrained and unrestrained.)</p> <p>(See GA File No. BM 3212)</p> <p><b>PROPRIETARY GYPSUM BOARD</b></p> <table border="0"> <tr> <td>American Gypsum Company LLC</td> <td>-</td> <td>5/8" FireBloc® Type C</td> </tr> <tr> <td>CertainTeed Gypsum Inc.</td> <td>-</td> <td>5/8" ProRoc® Type C Gypsum Panels</td> </tr> <tr> <td>CertainTeed Gypsum Canada Inc.</td> <td>-</td> <td>5/8" ProRoc® Type C Gypsum Panels</td> </tr> <tr> <td>Georgia-Pacific Gypsum LLC</td> <td>-</td> <td>5/8" ToughRock® Fireguard C™</td> </tr> <tr> <td>Lafarge North America Inc.</td> <td>-</td> <td>5/8" Firecheck® Type C</td> </tr> <tr> <td>National Gypsum Company</td> <td>-</td> <td>5/8" Gold Bond® Brand FIRE-SHIELD C™ Gypsum Board</td> </tr> <tr> <td>PABCO Gypsum</td> <td>-</td> <td>5/8" FLAME CURB® Super 'C'™</td> </tr> <tr> <td>Temple-Inland</td> <td>-</td> <td>5/8" TG-C</td> </tr> <tr> <td>United States Gypsum Company</td> <td>-</td> <td>5/8" SHEETROCK® Brand FIRECODE® C Core Gypsum Panels</td> </tr> </table> <p>Approx. Ceiling Weight: 3 psf                      Fire Test: UL R1319-79, 4-14-65 (Rev. 4-4-77); UL R3501, 88NK21023, 11-27-89; Based on UL R3660-7, -8, 11-12-87; UL R2717-61, 8-18-87; UL Design G512                      Sound Test: Est. see FC 2030 (NGC 4075, 3-25-69)</p> 	American Gypsum Company LLC	-	5/8" FireBloc® Type C	CertainTeed Gypsum Inc.	-	5/8" ProRoc® Type C Gypsum Panels	CertainTeed Gypsum Canada Inc.	-	5/8" ProRoc® Type C Gypsum Panels	Georgia-Pacific Gypsum LLC	-	5/8" ToughRock® Fireguard C™	Lafarge North America Inc.	-	5/8" Firecheck® Type C	National Gypsum Company	-	5/8" Gold Bond® Brand FIRE-SHIELD C™ Gypsum Board	PABCO Gypsum	-	5/8" FLAME CURB® Super 'C'™	Temple-Inland	-	5/8" TG-C	United States Gypsum Company	-	5/8" SHEETROCK® Brand FIRECODE® C Core Gypsum Panels
American Gypsum Company LLC	-	5/8" FireBloc® Type C																													
CertainTeed Gypsum Inc.	-	5/8" ProRoc® Type C Gypsum Panels																													
CertainTeed Gypsum Canada Inc.	-	5/8" ProRoc® Type C Gypsum Panels																													
Georgia-Pacific Gypsum LLC	-	5/8" ToughRock® Fireguard C™																													
Lafarge North America Inc.	-	5/8" Firecheck® Type C																													
National Gypsum Company	-	5/8" Gold Bond® Brand FIRE-SHIELD C™ Gypsum Board																													
PABCO Gypsum	-	5/8" FLAME CURB® Super 'C'™																													
Temple-Inland	-	5/8" TG-C																													
United States Gypsum Company	-	5/8" SHEETROCK® Brand FIRECODE® C Core Gypsum Panels																													
GA FILE NO. FC 3140	GENERIC	3 HOUR FIRE		<p><b>STEEL JOISTS, METAL LATH, GYPSUM PLASTER</b></p> <p>5/8" 1:2-1:3 gypsum-vermiculite plaster or 7/8" neat-wood fiber gypsum plaster applied over 3.4 lb. metal lath wire tied with 18 gage wire 5" o.c. to open web steel joists 24" o.c. supporting 3/8" rib metal lath and 2 1/2" concrete slab.</p> <p>Approx. Ceiling Weight: 4 psf                      Fire Test: BMS 92/43, 10-7-42</p> 																											
GA FILE NO. FC 3150	GENERIC	3 HOUR FIRE		<p><b>CONCRETE SLAB, CELLULAR STEEL DECK, METAL LATH, GYPSUM PLASTER</b></p> <p>5/8" thick mill-mixed gypsum-perlite plaster applied over 3.4 lb. metal lath wire tied to 3/4" cold rolled channels 12" o.c. wire tied to 1 1/2" cold rolled channels 48" o.c. suspended 16" with 8 gage steel wire 36" o.c. from 2" concrete slab over 3" cellular steel deck supported by steel beam. (Three hour restrained and unrestrained.)</p> <p>Approx. Ceiling Weight: 2.5 psf                      Fire Test: UL R3574-6, 7-25-57, UL Design A403</p> 																											
GA FILE NO. FC 4120	GENERIC	4 HOUR FIRE		<p><b>STEEL JOISTS, CONCRETE SLAB, METAL LATH, GYPSUM PLASTER</b></p> <p>7/8" 1:2-1:3 gypsum-vermiculite plaster applied over 3/8" rib metal lath wire tied 5" o.c. to open web steel joists 24" o.c. supporting 3/8" rib metal lath and 2 1/2" concrete slab.</p> <p>Approx. Ceiling Weight: 5 psf                      Fire Test: BMS 92/43, 10-7-42</p> 																											

\*Contact the manufacturer for more detailed information on proprietary products.

<b>FLOOR-CEILING SYSTEMS, STEEL FRAMED, WOOD FLOOR</b>			
<b>GA FILE NO. FC 4340</b>	<b>GENERIC</b>	<b>1 HOUR FIRE</b>	<b>50 to 54 STC SOUND</b>
<b>GYPSUM WALLBOARD, STEEL CHANNEL JOISTS, PLYWOOD FLOOR</b>			
<p><b>Base</b> layer 1/2" type X gypsum wallboard applied at right angles to resilient furring channels 16" o.c. with 1 1/4" Type S drywall screws 12" o.c. Resilient furring channels applied at right angles to channel shaped, minimum 8" deep, 18 gage galvanized steel joists 16" o.c. with 3/4" Type S-12 drywall screws. <b>Face</b> layer 1/2" type X gypsum wallboard applied at right angles to channels with end joints located midway between channels. Face layer attached to channels with 1 5/8" Type S drywall screws 12" o.c. End joints attached to base layer with 1 1/2" Type G screws 12" o.c. placed 1 1/2" back from either side of end joints. Joints offset 24" from base layer joints. 3 1/2" glass fiber batt insulation in joist space. Floor of 5/8" T &amp; G edge plywood applied at right angles to joists with 1 1/4" No. 10 bugle head screws pilot tip 6" o.c. and end joints and 12" o.c. at intermediate joists.</p> <p>STC tested with 1/4" carpet applied over a 3/8" foam pad.</p>		<p>Approx. Ceiling Weight: 4 psf                      Fire Test: NRCC A-4219.A, 4-29-98, Assembly FF-23                      Sound Test: NRCC B-3163.2, 3-15-01                      IIC &amp; Test: 69; NRCC B-3163.2, 3-15-01</p>	
<b>GA FILE NO. FC 4370</b>	<b>GENERIC</b>	<b>1 HOUR FIRE</b>	<b>45 to 49 STC SOUND</b>
<b>GYPSUM WALLBOARD, STEEL CHANNEL JOISTS, PLYWOOD FLOOR</b>			
<p><b>Base</b> layer 1/2" type X gypsum wallboard applied at right angles to resilient furring channels 16" o.c. with 1 1/4" Type S drywall screws 12" o.c. Resilient furring channels applied at right angles to channel shaped, minimum 8" deep, 18 gage galvanized steel joists 16" o.c. with 3/4" Type S-12 drywall screws. <b>Face</b> layer 1/2" type X gypsum wallboard applied at right angles to channels with end joints located midway between channels. Face layer attached to channels with 1 5/8" Type S drywall screws 12" o.c. End joints attached to base layer with 1 1/2" Type G screws 12" o.c. placed 1 1/2" back from either side of end joints. Joints offset 24" from base layer joints. 3 1/2" glass fiber batt insulation in joist space. Floor of 5/8" T &amp; G edge plywood applied at right angles to joists with 1 1/4" No. 10 bugle head screws with 3/4" pilot tip 6" o.c. and end joints and 12" o.c. at intermediate joists.</p>		<p>Approx. Ceiling Weight: 4 psf                      Fire Test: NRCC A-4219.A, 4-29-98, Assembly FF-23                      Sound Test: NRCC B-3163.1, 3-15-01                      IIC &amp; Test: 39; NRCC B-3163.1, 3-15-01</p>	
<b>GA FILE NO. FC 4490</b>	<b>GENERIC</b>	<b>1 HOUR FIRE</b>	<b>35 to 39 STC SOUND</b>
<b>STEEL CHANNEL JOISTS, GYPSUM WALLBOARD</b>			
<p><b>Base</b> layer 5/8" type X gypsum wallboard applied at right angles to channel shaped steel joists 24" o.c. with 1 1/4" Type S drywall screws 24" o.c. <b>Face</b> layer 5/8" type X gypsum wallboard or gypsum veneer base applied at right angles to joists with 1 7/8" Type S drywall screws 12" o.c. at joints and intermediate joists and 1 1/2" Type G drywall screws 12" o.c. placed 2" back on either side of end joints. Joints offset 24" from base layer joints. Steel joists supporting 1/2" wood structural panels applied at right angles to joists with screws. <b>Ceiling provides one hour fire resistance protection for framing.</b></p>		<p>Approx. Ceiling Weight: 5 psf                      Fire Test: FM FC 172, 2-25-72; ITS, 8-6-98                      Sound Test: Estimated</p>	

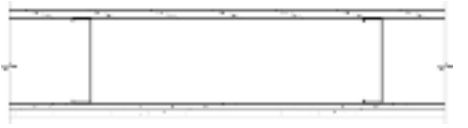
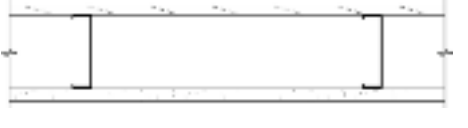
**FLOOR-CEILING SYSTEMS, STEEL FRAMED, WOOD FLOOR**

GA FILE NO. FC 4502	PROPRIETARY*	1 HOUR FIRE
<p align="center"><b>STEEL CHANNEL JOISTS, PLYWOOD FLOOR, GYPSUM WALLBOARD CEILING</b></p>		
<p><b>Base</b> layer 1/2" proprietary type X gypsum wallboard applied at right angles to channel shaped, minimum 7" deep, 18 gage galvanized steel joists 24" o.c. with 1" Type S-12 drywall screws 8" o.c. at butt joints and 12" o.c. at intermediate joists. <b>Face</b> layer 1/2" proprietary type X gypsum wallboard applied at right angles to joists with 1 1/2" Type G drywall screws at butt joints between joists and 1 5/8" Type S-12 drywall screws 12" o.c. at intermediate joists. Joints offset from base layer joints. Steel joists supporting 5/8" T &amp; G edge plywood floor applied at right angles to joists with 1 15/16" No. 6-20 S-12 point screws 6" o.c. at floor perimeter and end joints and 10" o.c. at intermediate joists. For alternate floor systems, consult manufacturer.</p>		<p>Approx. Ceiling Weight: 4 psf Fire Test: Based on UL R3660-7, -8, 11-12-87; UL R1319-133, 7-16-75; UL R7094, 90NK10635, 10-24-90; UL Design L524</p>
<p align="center"><b>PROPRIETARY GYPSUM BOARD</b></p>		
<p>American Gypsum Company LLC CertainTeed Gypsum Inc. Georgia-Pacific Gypsum LLC Lafarge North America Inc. National Gypsum Company</p>	<p>- 1/2" FireBloc® Type C - 1/2" ProRoc® Type C Gypsum Panels - 1/2" ToughRock® Fireguard C™ - 1/2" Firecheck® Type C - 1/2" Gold Bond® Brand FIRE-SHIELD C™ Gypsum Board</p>	
<p>PABCO Gypsum Temple-Inland United States Gypsum Company</p>	<p>- 1/2" FLAME CURB® Super 'C'™ - 1/2" TG-C - 1/2" SHEETROCK® Brand FIRECODE® C Core Gypsum Panels</p>	
GA FILE NO. FC 4503	GENERIC	1 HOUR FIRE
<p align="center"><b>GYPSUM WALLBOARD, STEEL CHANNEL JOISTS, PLYWOOD FLOOR</b></p>		
<p><b>Base</b> layer 1/2" type X gypsum wallboard applied at right angles to channel shaped, minimum 6" deep, 16 gage galvanized steel joists 24" o.c. with 1" Type S-12 drywall screws 24" o.c. <b>Face</b> layer 1/2" type X gypsum wallboard applied at right angles to joists with 1 5/8" Type S-12 drywall screws 12" o.c. at end joints and intermediate joists and 1 1/2" Type G screws 12" o.c. placed 3" back from either side of end joints and staggered 6" from Type S-12 screws at joint. Joints offset 24" from base layer joints.</p>		<p>Approx. Ceiling Weight: 4 psf Fire Test: FM FC 205-1, 11-16-73</p>
<p>Floor of 3/4" T &amp; G edge plywood applied at right angles to joists with 17/8" No. 6 Phillips head screws with 3/4" pilot tip 6" o.c. and end joints and 12" o.c. at intermediate joists.</p>		
GA FILE NO. FC 4504	GENERIC	1 HOUR FIRE
<p align="center"><b>GYPSUM WALLBOARD, STEEL CHANNEL JOISTS, WOOD STRUCTURAL PANEL FLOOR</b></p>		
<p><b>Base</b> layer 1/2" type X gypsum wallboard applied at right angles to channel shaped, minimum 8" deep, 18 gage galvanized steel joists 16" o.c. with 1 1/4" Type S-12 drywall screws 12" o.c. Base layer butt joints staggered 48" in adjacent courses. <b>Face</b> layer 1/2" type X gypsum wallboard applied at right angles to joists with end joints located midway between joists. Face layer attached to joists with 1 1/2" Type S-12 drywall screws 12" o.c. End joints attached to base layer with 1 1/2" Type G screws 12" o.c. placed 1 1/2" back from either side of end joints. Face layer edge joints offset 24" from base layer edge joints. Face layer end joints offset 36" from base layer end joints. Joists supporting 5/8" nominal wood structural panel floor with long edges T &amp; G attached at right angles to joists with 1 1/4" No. 10 bugle head screws with 3/4" pilot tip 6" o.c. at end joints and 12" o.c. at intermediate joists.</p>		<p>Approx. Ceiling Weight: 4 psf Fire Test: NRCC B-4216.1, 3-3-05, Assembly FF-51</p>

\*Contact the manufacturer for more detailed information on proprietary products.

**FLOOR-CEILING SYSTEMS, STEEL FRAMED, WOOD FLOOR**

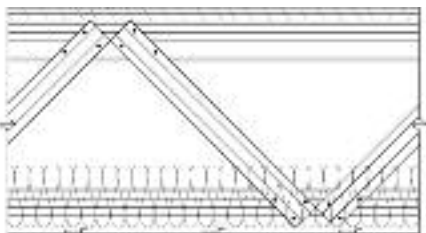
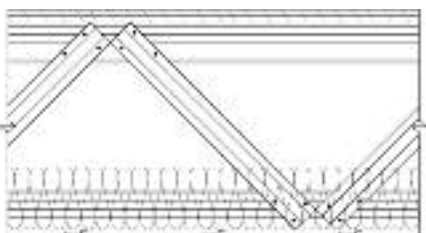
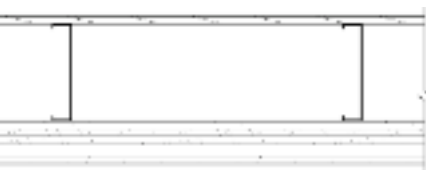
<b>GA FILE NO. FC 4515</b>	<b>PROPRIETARY*</b>	<b>1 HOUR FIRE</b>
<p style="text-align: center;"><b>STEEL TRUSSES, RESILIENT CHANNELS, MINERAL OR GLASS FIBER INSULATION, GYPSUM WALLBOARD</b></p> <p>One layer 5/8" proprietary type X gypsum wallboard or gypsum veneer base applied at right angles to resilient furring channels with 11/8" Type S drywall screws 12" o.c. Resilient channels spaced 12" o.c. when insulation is used or 16" o.c. when no insulation is used. Gypsum board end joints attached with screws 12" o.c. to additional pieces of channel 60" long located 3" back on either side of end joint. Resilient channels applied at right angles to bottom chord of light-gage steel trusses 48" o.c. with 1/2" Type S-12 screws. Optional glass fiber or mineral fiber batt or loose fill insulation applied directly over gypsum board. Trusses supporting 23/32" wood structural panel subfloor applied at right angles to trusses with construction adhesive and mechanical fasteners 12" o.c. and 15/32" wood structural panel underlayment applied at right angles to trusses with mechanical fasteners 12" o.c. Joints staggered between underlayment and subfloor.</p> <p style="text-align: center;"><b>PROPRIETARY GYPSUM BOARD</b></p> <p>National Gypsum Company - 5/8" Gold Bond® Brand FIRE-SHIELD C™ Gypsum Board</p>		 <p>Approx. Ceiling Weight: 3 psf Fire Test: UL R3501, 01NK49664, 9-5-02, UL Design L565</p>
<b>GA FILE NO. FC 4516</b>	<b>PROPRIETARY*</b>	<b>1 HOUR FIRE</b>
<p style="text-align: center;"><b>STEEL TRUSSES, RESILIENT CHANNELS, MINERAL OR GLASS FIBER INSULATION, GYPSUM WALLBOARD</b></p> <p>One layer 5/8" proprietary type X gypsum wallboard applied at right angles to resilient furring channels with 1" Type S drywall screws 12" o.c. Resilient channels spaced 12" o.c. when insulation is used or 16" o.c. when no insulation is used. Gypsum board end joints attached with screws 12" o.c. to additional pieces of channel 60" long located 3" back on either side of end joint. Resilient channels applied at right angles to bottom chord of light-gage steel trusses 48" o.c. with 1/2" Type S-12 screws. Optional glass fiber or mineral fiber batt or loose fill insulation applied directly over gypsum board. Trusses supporting 23/32" wood structural panel subfloor applied at right angles to trusses with construction adhesive and mechanical fasteners 12" o.c. and 15/32" wood structural panel underlayment applied at right angles to trusses with mechanical fasteners 12" o.c. Joints staggered between underlayment and subfloor.</p> <p style="text-align: center;"><b>PROPRIETARY GYPSUM BOARD</b></p> <p>American Gypsum Company LLC - 5/8" FireBloc® Type C Temple-Inland - 5/8" TG-C</p>		 <p>Approx. Ceiling Weight: 3 psf Fire Test: UL R14196, 07NK19575, 2-15-08; UL R6937, 08NK02787, 9-19-08; UL Design L597</p>
<b>GA FILE NO. FC 4750</b>	<b>GENERIC</b>	<b>2 HOUR FIRE</b>
<p style="text-align: center;"><b>WOOD FLOOR, STEEL CHANNEL JOISTS, GYPSUM WALLBOARD, RIGID FURRING CHANNELS</b></p> <p><b>Base</b> layer 5/8" type X gypsum wallboard applied at right angles to channel shaped, minimum 8" deep, 18 gage galvanized steel joists 24" o.c. with 11/8" Type S-12 drywall screws 12" o.c. <b>Second</b> layer 5/8" type X gypsum wallboard applied at right angles to joists with 15/8" Type S-12 drywall screws 12" o.c. Second layer joints offset 24" from base layer joints. <b>Third</b> layer 5/8" type X gypsum wallboard applied at right angles to joists with 23/8" Type S-12 drywall screws 12" o.c. Third layer joints offset 12" from second layer joints. Hat-shaped rigid furring channels 24" o.c. applied at right angles to joists over third layer with two 23/8" long Type S-12 drywall screws at each joist. <b>Face</b> layer 5/8" type X gypsum wallboard applied at right angles to furring channels with 11/8" Type S drywall screws 12" o.c. Joists supporting 3/4" T &amp; G edge plywood floor applied at right angles to joists with #10x15/8" screws 12".</p>		 <p>Approx. Ceiling Weight: 12 psf Fire Test: UL R4024, 02NK04478, UL Design L556; ULC Design M514</p>

*\*Contact the manufacturer for more detailed information on proprietary products.*

**FLOOR-CEILING SYSTEMS, WOOD FRAMED**

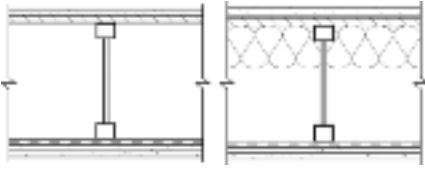
GA FILE NO. FC 5011	PROPRIETARY*	1 HOUR FIRE	60 to 64 STC SOUND
<p align="center"><b>WOOD I-JOISTS, WOOD STRUCTURAL PANELS, GYPSUM FLOOR TOPPING, RESILIENT CHANNELS, GLASS FIBER BATT OR LOOSE FILL INSULATION, GYPSUM WALLBOARD</b></p>			
<p><b>Base layer</b> 1/2" proprietary type X gypsum wallboard or gypsum veneer base applied at right angles to resilient furring channels 24" o.c. (16" o.c. when insulation is used) with 1" Type S drywall screws 16" o.c. Gypsum board end joints located midway between continuous channels and attached with screws 8" to additional pieces of channel 60" long located 3" back on either side of end joint. Resilient channels applied at right angles to minimum 10" deep wood I joists spaced a maximum of 19" o.c. with 1 1/4" Type S drywall screws. <b>Face layer</b> 1/2" proprietary type X gypsum wallboard or gypsum veneer base applied at right angles to resilient furring channels 1 5/8" Type S drywall screws 8" o.c. and 1 1/2" Type G screws 8" o.c. at the butt joints located mid span between the resilient channels. Glass fiber insulation secured to subfloor or loose fill insulation applied directly over gypsum board. Wood I joists supporting 1 9/32" wood structural panel subfloor applied at right angles to joists with construction adhesive and 6d ring shank nails 12" o.c. Minimum 1/2" proprietary gypsum floor topping applied over subfloor.</p> <p>STC rated with I joists spaced 24" o.c., 3 1/2" glass fiber insulation in joist spaces, 3/4" proprietary gypsum floor topping poured over 1/4" proprietary sound reduction mat, and with finish flooring of sheet vinyl, engineered wood laminate, and ceramic tile. (STC 64 when sheet vinyl or engineered wood laminate is applied to floor; STC 66 when tested with ceramic tile applied to floor.)</p>		<p>Approx. Ceiling Weight: 3 psf                  Fire Test:                  Sound Test:                  IIC &amp; Test:</p>	<p>UL R1319, 05NK04589, 2-4-05; UL R1319, 05NK09496, 3-31-05; UL Design L570                  RAL OT03-05, 4-22-03; RAL OT03-07, 4-29-03; RAL OT03-09, 6-18-03 (58 sheet vinyl), RAL OT03-06, 4-22-03; (62 engineered wood laminate) RAL OT03-08, 4-29-03; (54 ceramic tile) RAL OT03-10, 6-18-03</p>
<p align="center"><b>PROPRIETARY GYPSUM COMPONENTS</b></p> <p>United States Gypsum Company      - 1/2" SHEETROCK® Brand FIRECODE® C Core Gypsum Panels                  - LEVELROCK® Brand Floor Underlayment</p>			

This Space Left Blank

\*Contact the manufacturer for more detailed information on proprietary products.

**FLOOR-CEILING SYSTEMS, WOOD FRAMED****GA FILE NO. FC 5012****PROPRIETARY\*****1 HOUR  
FIRE****60 to 64 STC  
SOUND****WOOD TRUSSES, WOOD STRUCTURAL PANELS, GYPSUM  
FLOOR TOPPING, RESILIENT CHANNELS, GLASS OR MINERAL  
FIBER BATT OR BLANKET INSULATION OR LOOSE FILL  
CELLULOSE INSULATION, CEILING DAMPER,  
GYPSUM WALLBOARD**

One layer 5/8" proprietary type X gypsum wallboard or gypsum veneer base applied at right angles to resilient furring channels 16" o.c. (12" o.c. when insulation batts or blankets are draped over resilient channels or when loose fill insulation is applied to the back of the ceiling membrane) with 1" Type S drywall screws 8" o.c. Gypsum board end joints located midway between continuous channels and attached to additional pieces of channel 60" long with screws 8" o.c. Resilient furring channels applied at right angles to minimum 12" deep parallel chord wood trusses 24" o.c. with 1 1/4" Type S drywall screws. Glass fiber or mineral fiber batt or blanket insulation draped over the resilient channels, or loose-fill cellulose insulation spray applied to the back of the ceiling membrane. Wood trusses supporting 2 3/32" nominal wood structural panel subfloor applied at right angles to trusses with construction adhesive and 6d ring shank nails 12" o.c. 3/4" proprietary gypsum floor topping applied over subfloor. Optional ceiling damper (refer to manufacturer for information on the type of damper).

STC rated with I joists spaced 24" o.c., 3 1/2" glass fiber insulation against the floor side in joist spaces, 1" proprietary gypsum floor topping poured over 1/4" proprietary sound reduction mat, and with finish flooring of sheet vinyl, cushioned sheet vinyl, carpet & pad, ceramic tile, and engineered wood laminate. (STC 61 when engineered wood laminate is applied to floor; STC 62 when tested with sheet vinyl, cushioned sheet vinyl, carpet & pad, or ceramic tile applied to floor.)

**PROPRIETARY GYPSUM COMPONENTS**

United States Gypsum Company

- 5/8" SHEETROCK® Brand FIRECODE® C Core Gypsum Panels
- LEVELROCK® Brand Floor Underlayment

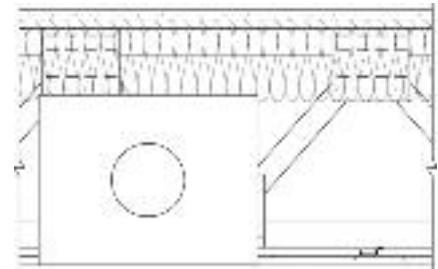

Approx. Ceiling

Weight: 3 psf

Fire Test: UL R1319, 97NK28582, 11-20-97, UL R5698, 04NK16820, 6-29-04, UL Design L521; UL R9660, 99NK7096, 5-17-99, UL R1319, 99NK7095, 5-17-99, UL Design L550; UL R15858, 02NK24136, 3-20-03, UL Design L563

Sound Test: RAL OT04-01, 1-19-04; RAL OT04-03, 1-20-04; RAL OT04-05, 1-21-04; RAL OT04-07, 1-26-04; RAL OT04-11, 4-16-04

IIC & Test: (81 generic C&P), RAL OT04-06, 1-21-04; (55 cushion sheet vinyl) RAL OT04-04, 1-20-04; (55 engineered wood laminate) RAL OT04-08, 1-26-04; (54 ceramic tile) RAL OT04-12, 4-16-04; (53 generic sheet vinyl) RAL OT04-02, 1-19-04

**GA FILE NO. FC 5104****PROPRIETARY\*****1 HOUR  
FIRE****55 to 59 STC  
SOUND****GYPSUM PANEL PRODUCTS, RESILIENT CHANNELS,  
WOOD JOISTS**

One layer 1/2" proprietary type X glass mat gypsum panels applied at right angles to resilient furring channels 24" o.c. with 1" Type S drywall screws 12" o.c. Gypsum board end joints located midway between continuous channels and attached to additional pieces of channel 60" long with screws at 12" o.c. Resilient channels applied at right angles to 2 x 10 wood joists 16" o.c. with 6d common nails. Wood joists supporting 1 9/32" plywood and 1" proprietary sanded gypsum underlayment.

STC rated with 3 1/2" glass fiber insulation in joist spaces and with carpet and pad. **Second layer of 1/2" or 5/8" type X gypsum wallboard required to achieve 1 hour fire resistance rating when glass fiber insulation is used.**

**PROPRIETARY GYPSUM PANEL PRODUCT**

Georgia-Pacific Gypsum LLC

- 1/2" DensArmor Plus® Fireguard C™ Interior Guard

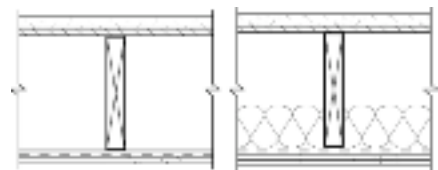

Approx. Ceiling

Weight: 2 psf

Fire Test: UL R2717, UL Design L502

Sound Test: G&amp;H BW-10 MT, 10-13-70

IIC &amp; Test: (73 C &amp; P)

G&amp;H BW-10 MT, 10-13-70

*\*Contact the manufacturer for more detailed information on proprietary products.*

**FLOOR-CEILING SYSTEMS, WOOD FRAMED**

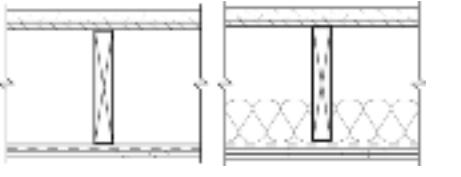
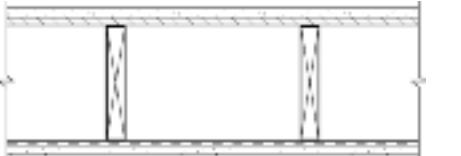
GA FILE NO. FC 5105	PROPRIETARY*	1 HOUR FIRE	55 to 59 STC SOUND																											
<p align="center"><b>GYPSUM WALLBOARD, RESILIENT CHANNELS, WOOD JOISTS</b></p> <p>One layer 1/2" proprietary type X gypsum wallboard or gypsum veneer base applied at right angles to resilient furring channels 24" o.c. with 1" Type S drywall screws 12" o.c. Gypsum board end joints located midway between continuous channels and attached to additional pieces of channel 60" long with screws at 12" o.c. Resilient channels applied at right angles to 2 x 10 wood joists 16" o.c. with 6d common nails. Wood joists supporting 19/32" plywood and 1" proprietary sanded gypsum underlayment.</p> <p>STC rated with 3 1/2" glass fiber insulation in joist spaces and with carpet and pad. <b>Second layer of 1/2" or 5/8" type X gypsum wallboard required to achieve 1 hour fire resistance rating when glass fiber insulation is used.</b></p> <p align="center"><b>PROPRIETARY GYPSUM BOARD</b></p> <table border="0"> <tr> <td>American Gypsum Company LLC</td> <td>-</td> <td>1/2" FireBloc® Type C</td> </tr> <tr> <td>CertainTeed Gypsum Inc.</td> <td>-</td> <td>1/2" ProRoc® Type C Gypsum Panels</td> </tr> <tr> <td>CertainTeed Gypsum Canada Inc.</td> <td>-</td> <td>1/2" ProRoc® Type C Gypsum Panels</td> </tr> <tr> <td>Georgia-Pacific Gypsum LLC</td> <td>-</td> <td>1/2" ToughRock® Fireguard C™</td> </tr> <tr> <td>Lafarge North America Inc.</td> <td>-</td> <td>1/2" Firecheck® Type C</td> </tr> <tr> <td>National Gypsum Company</td> <td>-</td> <td>1/2" Gold Bond® Brand FIRE-SHIELD C™ Gypsum Board</td> </tr> <tr> <td>PABCO Gypsum</td> <td>-</td> <td>1/2" FLAME CURB® Super 'C'™</td> </tr> <tr> <td>Temple-Inland</td> <td>-</td> <td>1/2" TG-C</td> </tr> </table>		American Gypsum Company LLC	-	1/2" FireBloc® Type C	CertainTeed Gypsum Inc.	-	1/2" ProRoc® Type C Gypsum Panels	CertainTeed Gypsum Canada Inc.	-	1/2" ProRoc® Type C Gypsum Panels	Georgia-Pacific Gypsum LLC	-	1/2" ToughRock® Fireguard C™	Lafarge North America Inc.	-	1/2" Firecheck® Type C	National Gypsum Company	-	1/2" Gold Bond® Brand FIRE-SHIELD C™ Gypsum Board	PABCO Gypsum	-	1/2" FLAME CURB® Super 'C'™	Temple-Inland	-	1/2" TG-C					
American Gypsum Company LLC	-	1/2" FireBloc® Type C																												
CertainTeed Gypsum Inc.	-	1/2" ProRoc® Type C Gypsum Panels																												
CertainTeed Gypsum Canada Inc.	-	1/2" ProRoc® Type C Gypsum Panels																												
Georgia-Pacific Gypsum LLC	-	1/2" ToughRock® Fireguard C™																												
Lafarge North America Inc.	-	1/2" Firecheck® Type C																												
National Gypsum Company	-	1/2" Gold Bond® Brand FIRE-SHIELD C™ Gypsum Board																												
PABCO Gypsum	-	1/2" FLAME CURB® Super 'C'™																												
Temple-Inland	-	1/2" TG-C																												
<p align="center"><b>GYPSUM WALLBOARD, RESILIENT CHANNELS, WOOD JOISTS, GYPSUM FLOOR UNDERLAYMENT</b></p> <p>One layer 1/2" proprietary type X gypsum wallboard or gypsum veneer base applied at right angles to resilient furring channels 24" o.c. with 1" Type S drywall screws 12" o.c. Gypsum board end joints located midway between continuous channels and attached to additional pieces of channel 54" long with screws at 12" o.c. Resilient furring channels applied at right angles to 2 x 10 wood joists 16" o.c. with 1 1/4" Type W screws. Wood joists supporting 19/32" plywood subfloor and 3/4" 1000 psi sanded gypsum floor underlayment.</p> <p align="center"><b>PROPRIETARY GYPSUM BOARD</b></p> <table border="0"> <tr> <td>American Gypsum Company LLC</td> <td>-</td> <td>1/2" FireBloc® Type C</td> </tr> <tr> <td>CertainTeed Gypsum Inc.</td> <td>-</td> <td>1/2" ProRoc® Type C Gypsum Panels</td> </tr> <tr> <td>CertainTeed Gypsum Canada Inc.</td> <td>-</td> <td>1/2" ProRoc® Type C Gypsum Panels</td> </tr> <tr> <td>Georgia-Pacific Gypsum LLC</td> <td>-</td> <td>1/2" ToughRock® Fireguard C™</td> </tr> <tr> <td>Lafarge North America Inc.</td> <td>-</td> <td>1/2" Firecheck® Type C</td> </tr> <tr> <td>National Gypsum Company</td> <td>-</td> <td>1/2" Gold Bond® Brand FIRE-SHIELD C™ Gypsum Board</td> </tr> <tr> <td>PABCO Gypsum</td> <td>-</td> <td>1/2" FLAME CURB® Super 'C'™</td> </tr> <tr> <td>Temple-Inland</td> <td>-</td> <td>1/2" TG-C</td> </tr> <tr> <td>United States Gypsum Company</td> <td>-</td> <td>1/2" SHEETROCK® Brand FIRECODE® C Core Gypsum Panels</td> </tr> </table>		American Gypsum Company LLC	-	1/2" FireBloc® Type C	CertainTeed Gypsum Inc.	-	1/2" ProRoc® Type C Gypsum Panels	CertainTeed Gypsum Canada Inc.	-	1/2" ProRoc® Type C Gypsum Panels	Georgia-Pacific Gypsum LLC	-	1/2" ToughRock® Fireguard C™	Lafarge North America Inc.	-	1/2" Firecheck® Type C	National Gypsum Company	-	1/2" Gold Bond® Brand FIRE-SHIELD C™ Gypsum Board	PABCO Gypsum	-	1/2" FLAME CURB® Super 'C'™	Temple-Inland	-	1/2" TG-C	United States Gypsum Company	-	1/2" SHEETROCK® Brand FIRECODE® C Core Gypsum Panels	<p align="center"><b>1 HOUR FIRE</b></p> <p align="center"><b>55 to 59 FSTC SOUND</b></p>	
American Gypsum Company LLC	-	1/2" FireBloc® Type C																												
CertainTeed Gypsum Inc.	-	1/2" ProRoc® Type C Gypsum Panels																												
CertainTeed Gypsum Canada Inc.	-	1/2" ProRoc® Type C Gypsum Panels																												
Georgia-Pacific Gypsum LLC	-	1/2" ToughRock® Fireguard C™																												
Lafarge North America Inc.	-	1/2" Firecheck® Type C																												
National Gypsum Company	-	1/2" Gold Bond® Brand FIRE-SHIELD C™ Gypsum Board																												
PABCO Gypsum	-	1/2" FLAME CURB® Super 'C'™																												
Temple-Inland	-	1/2" TG-C																												
United States Gypsum Company	-	1/2" SHEETROCK® Brand FIRECODE® C Core Gypsum Panels																												
<p>Approx. Ceiling Weight: 2 psf</p> <p>Fire Test: UL R6352, 4-21-71, UL Design L502</p> <p>Sound Test: G&amp;H BW-10 MT, 10-13-70</p> <p>IIC &amp; Test: (73 C &amp; P) G&amp;H BW-10 MT, 10-13-70</p>																														
<p>Approx. Ceiling Weight: 3 psf</p> <p>Fire Test: UL R1319-65, 11-16-64, UL Design L514</p> <p>Field Sound Test: INTEST 5-761-3, 12-5-77</p>																														

\*Contact the manufacturer for more detailed information on proprietary products.

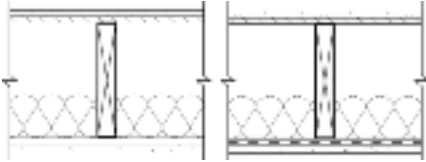
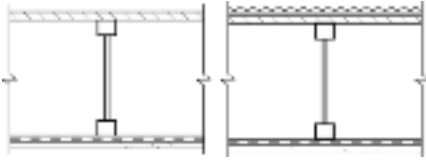

<b>FLOOR-CEILING SYSTEMS, WOOD FRAMED</b>			
<b>GA FILE NO. FC 5109</b>	<b>PROPRIETARY*</b>	<b>1 HOUR FIRE</b>	<b>55 to 59 STC SOUND</b>
<b>WOOD JOISTS, WOOD STRUCTURAL PANELS, GYPSUM FLOOR TOPPING, RESILIENT CHANNELS, GLASS OR MINERAL FIBER BATT OR LOOSE FILL INSULATION, GYPSUM WALLBOARD</b>			
<p>One layer 5/8" proprietary type X gypsum wallboard or gypsum veneer base applied at right angles to resilient furring channels 24" o.c. (16" o.c. when batt insulation is used; 12" o.c. when loose fill insulation is used) with 1" Type S drywall screws 12" o.c. Gypsum board end joints located midway between continuous channels and attached with screws 8" to additional pieces of channel 60" long located 3" back on either side of end joint. Resilient channels applied at right angles to nominal 2 x 10 wood joists spaced a maximum of 24" o.c. with 1 1/4" Type S drywall screws. Glass or mineral fiber batt insulation stapled to subfloor or loose fill insulation applied directly over gypsum board. Wood joists supporting 1 5/32" wood structural panel subfloor applied at right angles to joists with construction adhesive and 6d ring shank nails 12" o.c. Minimum 1/2" proprietary gypsum floor topping applied over subfloor.</p> <p>STC and IIC rated with both joists and resilient channels spaced 16" o.c., 3 1/2" glass fiber insulation in joist spaces, 3/4" proprietary gypsum floor topping poured over 1/4" proprietary sound reduction mat, and with finish flooring of C&amp;P, sheet vinyl, and engineered wood laminate.</p>		<p>Approx. Ceiling Weight: 3 psf</p> <p>Fire Test: UL R1319, 05NK04589, 2-4-05; UL R1319, 05NK09496, 3-31-05; UL Design L569</p> <p>Sound Test: RAL TL04-97 &amp; 98, 4-22-04; RAL TL04-99, -100, -101, 4-26-04; RAL TL04-109, 4-30-04</p> <p>IIC &amp; Test: (73 generic C&amp;P), RAL IN04-010, 4-22-04; (52 cushion sheet vinyl) RAL IN04-011, 4-22-04; (51 engineered wood laminate) RAL IN04-012, 4-26-04; (50 cushion sheet vinyl) RAL IN04-013, 4-26-04; (48 generic sheet vinyl) RAL IN04-014, 4-26-04; (45 cushion sheet vinyl &amp; channels spaced 24" o.c.) RAL IN04-015, 4-30-04</p>	
<b>PROPRIETARY GYPSUM COMPONENTS</b>			
United States Gypsum Company	- 5/8" SHEETROCK® Brand FIRECODE® C Core Gypsum Panels		
	- LEVELROCK® Brand Floor Underlayment		
<b>GA FILE NO. FC 5111</b>	<b>GENERIC</b>	<b>1 HOUR FIRE</b>	<b>50 to 54 STC SOUND</b>
<b>WOOD I-JOISTS, GYPSUM WALLBOARD, RESILIENT CHANNELS</b>			
<p><b>Base</b> layer 1/2" type X gypsum wallboard applied at right angles to resilient channels 16" o.c. with 1 1/4" Type S drywall screws 12" o.c. Resilient channels applied at right angles to minimum 9 1/2" deep wood I-joists, with minimum 1 1/4" deep x 1 1/2" wide flanges and minimum 3/8" webs, 24" o.c. with 1 1/4" Type W drywall screws. <b>Face</b> layer 1/2" type X gypsum wallboard applied at right angles to channels with 1 5/8" Type S drywall screws 12" o.c. Face layer end joints located midway between channels and attached to base layer with 1 1/2" Type G screws 12" o.c. Edge joints offset 24" from base layer edge joints. Wood I-joists supporting 5/8" oriented strand board applied at right angles to I-joists with 8d common nails 12" o.c.</p> <p>STC and IIC tested with 40 oz carpet over 1/4" foam pad.</p>		<p>Approx. Ceiling Weight: 5 psf</p> <p>Fire Test: NRCC A-4440.1 (Revised), 6-24-97</p> <p>Sound Test: NRCC B-3150.2, 6-30-00</p> <p>IIC &amp; Test: (68 C &amp; P) NRCC B-3150.2, 6-30-00</p>	

\*Contact the manufacturer for more detailed information on proprietary products.

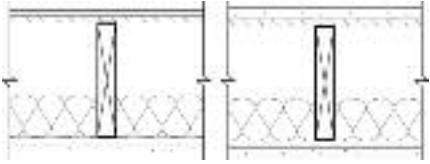
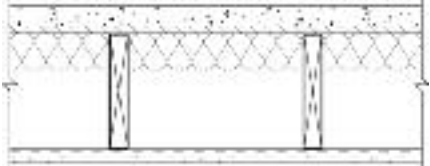

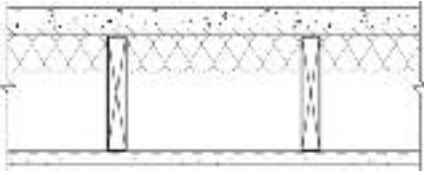
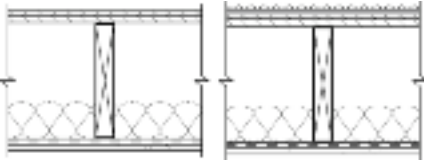

FLOOR-CEILING SYSTEMS, WOOD FRAMED		1 HOUR FIRE	50 to 54 STC SOUND
GA FILE NO. FC 5112	PROPRIETARY*		
<p align="center"><b>WOOD JOISTS, WOOD STRUCTURAL PANELS, GYPSUM FLOOR TOPPING, RESILIENT CHANNELS, GLASS OR MINERAL FIBER BATT OR LOOSE FILL INSULATION, GYPSUM WALLBOARD</b></p> <p>One layer 5/8" proprietary type X gypsum wallboard or gypsum veneer base applied at right angles to resilient furring channels 24" o.c. (16" o.c. when batt insulation is used; 12" o.c. when loose fill insulation is used) with 1" Type S drywall screws 12" o.c. Gypsum board end joints located midway between continuous channels and attached with screws 8" to additional pieces of channel 60" long located 3" back on either side of end joint. Resilient channels applied at right angles to nominal 2 x 10 wood joists spaced a maximum of 24" o.c. with 1 1/4" Type S drywall screws. Glass or mineral fiber batt insulation stapled to subfloor or or loose fill insulation applied directly over gypsum board. Wood joists supporting 1 5/32" wood structural panel subfloor applied at right angles to joists with construction adhesive and 6d ring shank nails 12" o.c. Minimum 1/2" proprietary gypsum floor topping applied over subfloor.</p> <p>STC and IIC rated with both joists and resilient channels spaced 16" o.c., 3 1/2" glass fiber insulation in joist spaces, 1" proprietary gypsum floor topping poured over 1/4" proprietary sound reduction mat, and with finish flooring of C&amp;P, sheet vinyl, engineered wood laminate, and ceramic tile.</p> <p align="center"><b>PROPRIETARY GYPSUM COMPONENTS</b></p> <p>United States Gypsum Company      - 5/8" SHEETROCK® Brand FIRECODE® C Core Gypsum Panels                      - LEVELROCK® Brand Floor Underlayment</p>			<p>Approx. Ceiling Weight: 3 psf</p> <p>Fire Test: UL R1319, 05NK04589, 2-4-05; UL R1319, 05NK09496, 3-31-05; UL Design L569</p> <p>Sound Test: RAL TL04-31 &amp; 32, 2-11-04; RAL TL04-33 &amp; 34, 2-22-04; RAL TL04-67, 3-19-04</p> <p>IIC &amp; Test: (51 generic sheet vinyl), RAL IN04-004, 4-22-04; (77 generic C&amp;P) RAL IN04-005, 4-22-04; (54 cushion sheet vinyl) RAL IN04-006, 4-26-04; (55 engineered wood laminate) RAL IN04-007, 4-26-04; (52 ceramic tile) RAL IN04-009, 4-26-04</p>
GA FILE NO. FC 5115	PROPRIETARY*		
<p align="center"><b>WOOD JOISTS, GYPSUM WALLBOARD, RESILIENT CHANNELS, GLASS FIBER INSULATION</b></p> <p>One layer 5/8" proprietary type X gypsum wallboard or gypsum veneer base applied at right angles to resilient furring channels 24" o.c. with 1" Type S drywall screws 12" o.c. Gypsum board end joints located midway between continuous channels and attached to additional pieces of channel 54" long with screws 12" o.c. Resilient furring channels applied at right angles to 2 x 10 wood joists 16" o.c. with 1 1/4" Type W drywall screws. Wood joists supporting 5/8" interior plywood with exterior glue subfloor and 1 5/8" perlite-sand concrete reinforced with No. 19 SWG galvanized hexagonal wire mesh. 3" glass fiber insulation 0.90 pcf in joist space stapled to subfloor.</p> <p align="center"><b>PROPRIETARY GYPSUM BOARD</b></p> <p>United States Gypsum Company      - 5/8" SHEETROCK® Brand FIRECODE® C Core Gypsum Panels</p>			<p>Approx. Ceiling Weight: 2 psf</p> <p>Fire Test: UL R3453-7, 5-1-70; UL Design L516</p> <p>Sound Test: KAL L 224-28-65, 3-30-65</p> <p>IIC &amp; Test: (74 C &amp; P) KAL L 224-27-65, 3-30-65</p>

*\*Contact the manufacturer for more detailed information on proprietary products.*

<b>FLOOR-CEILING SYSTEMS, WOOD FRAMED</b>																											
<b>GA FILE NO. FC 5116</b>	<b>PROPRIETARY*</b>	<b>1 HOUR FIRE</b>	<b>50 to 54 STC SOUND</b>																								
<p style="text-align: center;"><b>WOOD JOISTS, GYPSUM WALLBOARD, RESILIENT CHANNELS, GLASS FIBER INSULATION</b></p> <p>One layer 5/8" proprietary type X gypsum wallboard or gypsum veneer base applied at right angles to resilient furring channels 24" o.c. with 1" Type S drywall screws 12" o.c. Gypsum board end joints located midway between continuous channels and attached to additional pieces of channel 54" long with screws at 12" o.c. Resilient furring channels applied at right angles to 2 x 10 wood joists 16" o.c. with 1 1/4" Type W drywall screws. Wood joists supporting 5/8" interior plywood with exterior glue subfloor and 1 5/8" perlite-sand concrete reinforced with No. 19 SWG galvanized hexagonal wire mesh. 3" glass fiber insulation 0.90 pcf in joist space stapled to subfloor.</p> <p style="text-align: center;"><b>PROPRIETARY GYPSUM BOARD</b></p> <table border="0"> <tr> <td>American Gypsum Company LLC</td> <td>-</td> <td>5/8" FireBloc® Type C</td> </tr> <tr> <td>CertainTeed Gypsum Inc.</td> <td>-</td> <td>5/8" ProRoc® Type C Gypsum Panels</td> </tr> <tr> <td>CertainTeed Gypsum Canada Inc.</td> <td>-</td> <td>5/8" ProRoc® Type C Gypsum Panels</td> </tr> <tr> <td>Georgia-Pacific Gypsum LLC</td> <td>-</td> <td>5/8" ToughRock® Fireguard C™</td> </tr> <tr> <td>Lafarge North America Inc.</td> <td>-</td> <td>5/8" Firecheck® Type C</td> </tr> <tr> <td>National Gypsum Company</td> <td>-</td> <td>5/8" Gold Bond® Brand FIRE-SHIELD C™ Gypsum Board</td> </tr> <tr> <td>PABCO Gypsum</td> <td>-</td> <td>5/8" FLAME CURB® Super 'C'™</td> </tr> <tr> <td>Temple-Inland</td> <td>-</td> <td>5/8" TG-C</td> </tr> </table>		American Gypsum Company LLC	-	5/8" FireBloc® Type C	CertainTeed Gypsum Inc.	-	5/8" ProRoc® Type C Gypsum Panels	CertainTeed Gypsum Canada Inc.	-	5/8" ProRoc® Type C Gypsum Panels	Georgia-Pacific Gypsum LLC	-	5/8" ToughRock® Fireguard C™	Lafarge North America Inc.	-	5/8" Firecheck® Type C	National Gypsum Company	-	5/8" Gold Bond® Brand FIRE-SHIELD C™ Gypsum Board	PABCO Gypsum	-	5/8" FLAME CURB® Super 'C'™	Temple-Inland	-	5/8" TG-C	 <p>Approx. Ceiling Weight: 2 psf                      Fire Test: UL R3453-7, 5-1-70; Based on UL R3660-7, -8, 11-12-87; R2717-61, 8-18-87; Based on UL R7094, 90NK10635, 10-24-90; Based on UL R8742, 88NK22591, 10-6-88; UL Design L516                      Sound Test: KAL L 224-28-65, 3-30-65                      IIC &amp; Test: (74 C &amp; P) KAL L 224-27-65, 3-30-65</p>	
American Gypsum Company LLC	-	5/8" FireBloc® Type C																									
CertainTeed Gypsum Inc.	-	5/8" ProRoc® Type C Gypsum Panels																									
CertainTeed Gypsum Canada Inc.	-	5/8" ProRoc® Type C Gypsum Panels																									
Georgia-Pacific Gypsum LLC	-	5/8" ToughRock® Fireguard C™																									
Lafarge North America Inc.	-	5/8" Firecheck® Type C																									
National Gypsum Company	-	5/8" Gold Bond® Brand FIRE-SHIELD C™ Gypsum Board																									
PABCO Gypsum	-	5/8" FLAME CURB® Super 'C'™																									
Temple-Inland	-	5/8" TG-C																									
<b>GA FILE NO. FC 5120</b>	<b>GENERIC</b>	<b>1 HOUR FIRE</b>	<b>50 to 54 STC SOUND</b>																								
<p style="text-align: center;"><b>WOOD JOISTS, GYPSUM WALLBOARD, RESILIENT CHANNELS, GLASS FIBER INSULATION</b></p> <p>One layer 1/2" type X gypsum wallboard or gypsum veneer base applied at right angles to resilient furring channels 24" o.c. with 1" Type S drywall screws 8" o.c. at ends and 12" o.c. at intermediate furring channels. Gypsum board end joints located midway between continuous channels and attached to additional pieces of channel 64" long with screws 8" o.c. Resilient furring channels applied at right angles to 2 x 10 wood joists 16" o.c. with 6d coated nails, 17/8" long, 0.085" shank, 1/4" heads, two per joist. Wood joists supporting 5/8" interior plywood with exterior glue subfloor and 3/8" particle board, 1.5 psf. 3 1/2" glass fiber insulation batts, 0.7 pcf, friction fit in joist cavities supported alternately every 12" by wire rods and resilient furring channels.</p> <p>Sound tested with carpet and pad and with insulation stapled to joists.</p>		 <p>Approx. Ceiling Weight: 2 psf                      Fire Test: FM FC-181, 8-31-72                      Sound Test: G&amp;H OC-3MT, 10-13-71                      IIC &amp; Test: (73 C &amp; P) G&amp;H OC-3MT, 10-13-71</p>																									
<b>GA FILE NO. FC 5240</b>	<b>GENERIC</b>	<b>1 HOUR FIRE</b>	<b>45 to 49 STC SOUND</b>																								
<p style="text-align: center;"><b>WOOD JOISTS, GYPSUM WALLBOARD, RESILIENT CHANNELS</b></p> <p>One layer 1/2" type X gypsum wallboard or gypsum veneer base applied at right angles to resilient furring channels 24" o.c. with 1" Type S drywall screws 12" o.c. Gypsum board end joints located midway between continuous channels and attached to additional pieces of channel 54" long with screws 12" o.c. Resilient furring channels applied at right angles to 2 x 10 wood joists 16" o.c. with 1 1/4" Type W drywall screws. Wood joists supporting 1" nominal T &amp; G wood subfloor and 1" nominal wood finish floor, or 19/32" plywood finished floor with long edges T &amp; G and 15/32" interior plywood with exterior glue subfloor perpendicular to joists with joints staggered.</p>		 <p>Approx. Ceiling Weight: 3 psf                      Fire Test: UL R1319-65, 11-16-64, UL Design L514                      Sound Test: CK 6512-6, 7, 4-15-65                      IIC &amp; Test: 39 (67 C &amp; P) CK 6512-6, 4-15-65</p>																									

\*Contact the manufacturer for more detailed information on proprietary products.

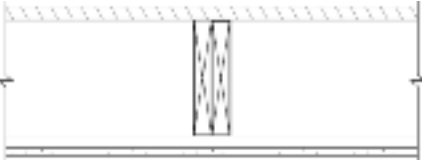
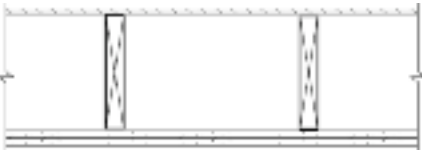

**FLOOR-CEILING SYSTEMS, WOOD FRAMED**

<p><b>GA FILE NO. FC 5241</b></p>	<p><b>GENERIC</b></p>	<p><b>1 HOUR FIRE</b></p>	<p><b>45 to 49 STC SOUND</b></p>
<p align="center"><b>WOOD I-JOISTS, GYPSUM WALLBOARD, RESILIENT CHANNELS</b></p> <p><b>Base</b> layer 1/2" type X gypsum wallboard applied at right angles to resilient channels 16" o.c. with 1 1/4" Type S drywall screws 12" o.c. Resilient channels applied at right angles to minimum 9 1/2" deep wood I-joists, with minimum 1 1/4" deep x 1 1/2" wide flanges and minimum 3/8" webs, 24" o.c. with 1 1/4" Type W drywall screws. <b>Face</b> layer 1/2" type X gypsum wallboard applied at right angles to channels with 1 5/8" Type S drywall screws 12" o.c. Face layer end joints located midway between channels and attached to base layer with 1 1/2" Type G screws 12" o.c. Edge joints offset 24" from base layer edge joints. Wood I-joists supporting 5/8" oriented strand board applied at right angles to I-joists with 8d common nails 12" o.c.</p>			<p>Approx. Ceiling Weight: 5 psf                  Fire Test: NRCC A-4440.1 (Revised), 6-24-97                  Sound Test: NRCC B-3150.1, 6-30-00                  IIC &amp; Test: NRCC B-3150.1, 6-30-00; NRCC B-3150.2, 6-30-00</p>
<p><b>GA FILE NO. FC 5242</b></p>	<p><b>GENERIC</b></p>	<p><b>1 HOUR FIRE</b></p>	<p><b>45 to 49 STC SOUND</b></p>
<p align="center"><b>WOOD JOISTS, GYPSUM WALLBOARD, RESILIENT CHANNELS</b></p> <p>One layer 1/2" type X gypsum wallboard or gypsum veneer base applied at right angles to resilient furring channels 24" o.c. with 1" Type S drywall screws 11" o.c. Gypsum board end joints located midway between continuous channels and attached to additional pieces of channel 54" long with screws 12" o.c. Resilient furring channels applied at right angles to 2 x 10 wood joists 16" o.c. with 1 1/4" Type W drywall screws or 6d common nails. Wood joists supporting 1" nominal T &amp; G wood subfloor and 1" nominal wood finish floor, or 5/8" plywood finished floor with long edges T &amp; G and 1/2" interior plywood with exterior glue subfloor perpendicular to joists with joints staggered.</p>			<p>Approx. Ceiling Weight: 2 psf                  Fire Test: UL R3543-8, 7-8-68, UL Design L517                  Sound Test: See FC 5240 (CK 6512-6, -7, 4-15-65)</p>
<p><b>GA FILE NO. FC 5250</b></p>	<p><b>GENERIC</b></p>	<p><b>1 HOUR FIRE</b></p>	<p><b>45 to 49 STC SOUND</b></p>
<p align="center"><b>WOOD JOISTS, GYPSUM WALLBOARD, RESILIENT CHANNELS</b></p> <p>One layer 1/2" type X gypsum wallboard or gypsum veneer base applied at right angles to resilient furring channels 24" o.c. with 1" Type S drywall screws 12" o.c. Gypsum board end joints located midway between continuous channels and attached to additional pieces of channel 60" long with screws 12" o.c. Resilient furring channels applied at right angles to 2 x 10 wood joists 16" o.c. with 6d coated nails, 2" long, 0.113" shank, 17/64" heads. Wood joists supporting 1" nominal wood subfloor and 1" nominal wood finish floor, or 19/32" plywood finished floor with long edges T &amp; G and 15/32" interior plywood with exterior glue subfloor perpendicular to joists with joints staggered.</p>			<p>Approx. Ceiling Weight: 2 psf                  Fire Test: UL R2717-29, 1-24-64, UL Design L502; ULC Design M501                  Sound Test: RAL TL64-155, 2-7-64                  IIC &amp; Test: 39 (67 C &amp; P) See FC 5240 (CK 6512-6, 4-15-65)</p>

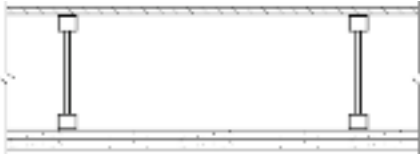
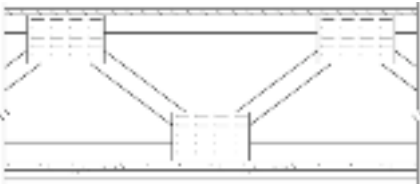
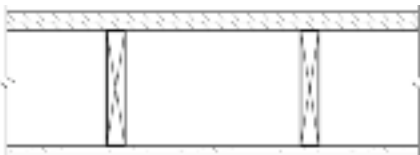

<b>FLOOR-CEILING SYSTEMS, WOOD FRAMED</b>			
<b>GA FILE NO. FC 5300</b>	<b>GENERIC</b>	<b>1 HOUR FIRE</b>	<b>40 to 44 STC SOUND</b>
<b>WOOD JOISTS, GYPSUM WALLBOARD, RESILIENT CHANNELS</b>			
<p>One layer 1/2" type X gypsum wallboard or gypsum veneer base applied at right angles to resilient furring channels 24" o.c. with 1" Type S drywall screws 12" o.c. Gypsum board end joints located midway between continuous channels and attached to additional pieces of channels 53" long with screws 12" o.c. Resilient furring channels applied at right angles to 2 x 10 wood joists 16" o.c. with two 4d coated nails, 1 1/2" long, 0.080" shank, and 7/32" heads, per joist. Wood joists supporting 1" nominal T &amp; G wood subfloor and 1" nominal wood finish floor, or 5/8" plywood finished floor with long edges T &amp; G and 15/32" interior plywood with exterior glue subfloor perpendicular to joists with joints staggered.</p>		<p>Approx. Ceiling Weight: 2 psf                      Fire Test: UL R3501-29, 3-23-64, UL Design L515                      Sound Test: NGC 4010, 3-21-66 (Rev. 12-23-70)                      IIC &amp; Test: 38 (63 C &amp; P) NGC 5016, 3-17-66</p>	
<b>GA FILE NO. FC 5310</b>	<b>GENERIC</b>	<b>1 HOUR FIRE</b>	<b>40 to 44 STC SOUND</b>
<b>WOOD JOISTS, GYPSUM WALLBOARD</b>			
<p>One layer 5/8" type X gypsum wallboard or gypsum veneer base applied at right angles to rigid furring channels 24" o.c. with 1" Type S drywall screws 12" o.c. Gypsum board end joints located midway between continuous channels and attached to additional pieces of channel 60" long with screws 12" o.c. Rigid furring channels applied at right angles to 4 x 10 or double 2 x 10 wood joists 48" o.c. with two 1 1/4" Type S drywall screws at each joist. Wood joists supporting 1 1/8" T &amp; G plywood floor.</p>		<p>Approx. Ceiling Weight: 2.5 psf                      Fire Test: UL R1319-47, 5-8-63, UL Design L508                      Sound Test: Estimated</p>	
<b>GA FILE NO. FC 5406</b>	<b>GENERIC</b>	<b>1 HOUR FIRE</b>	<b>35 to 39 STC SOUND</b>
<b>WOOD JOISTS, GYPSUM WALLBOARD</b>			
<p><b>Base</b> layer 5/8" type X gypsum wallboard applied at right angles to 2 x 10 wood joists 24" o.c. with 1 1/4" Type W or S drywall screws 24" o.c. <b>Face</b> layer 5/8" type X gypsum wallboard or gypsum veneer base applied at right angles to joists with 17/8" Type W or S drywall screws 12" o.c. at joints and intermediate joists and 1 1/2" Type G drywall screws 12" o.c. placed 2" back on either side of end joints. Joints offset 24" from base layer joints. Wood joists supporting 1/2" plywood with exterior glue applied at right angles to joists with 8d nails. <b>Ceiling provides one hour fire resistance protection for framing, including trusses.</b></p>		<p>Approx. Ceiling Weight: 5 psf                      Fire Test: FM FC 172, 2-25-72; ITS, 8-6-98                      Sound Test: Estimated</p>	

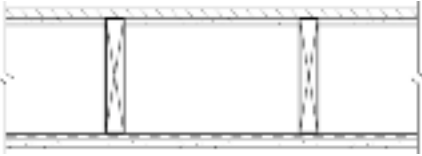
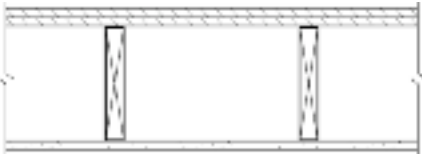
**FLOOR-CEILING SYSTEMS, WOOD FRAMED**

GA FILE NO. FC 5407	GENERIC	1 HOUR FIRE	35 to 39 STC SOUND
<p style="text-align: center;"><b>WOOD I-JOISTS, GYPSUM WALLBOARD</b></p> <p><b>Base</b> layer 5/8" type X gypsum wallboard applied at right angles to wood I-joists 24" o.c. with 1 1/4" Type W or S drywall screws 24" o.c. <b>Face</b> layer 5/8" type X gypsum wallboard or gypsum veneer base applied at right angles to I-joists with 1 7/8" Type W or S drywall screws 12" o.c. at joints and intermediate I-joists and 1 1/2" Type G drywall screws 12" o.c. placed 2" back on either side of end joints. Joints offset 24" from base layer joints. Wood I-joists supporting 1/2" wood structural panels applied at right angles to joists with 8d nails. <b>Ceiling provides one hour fire resistance protection for I-joists.</b></p>			<p>Approx. Ceiling Weight: 5 psf Fire Test: FM FC 172, 2-25-72; ITS, 8-6-98 Sound Test: Estimated</p>
GA FILE NO. FC 5408	GENERIC	1 HOUR FIRE	35 to 39 STC SOUND
<p style="text-align: center;"><b>WOOD TRUSSES, GYPSUM WALLBOARD</b></p> <p><b>Base</b> layer 5/8" type X gypsum wallboard applied at right angles to parallel chord wood trusses 24" o.c. with 1 1/4" Type W or S drywall screws 24" o.c. <b>Face</b> layer 5/8" type X gypsum wallboard or gypsum veneer base applied at right angles to trusses with 1 7/8" Type W or S drywall screws 12" o.c. at joints and intermediate trusses and 1 1/2" Type G drywall screws 12" o.c. placed 2" back on either side of end joints. Joints offset 24" from base layer joints. Trusses supporting 1/2" wood structural panels applied at right angles to trusses with 8d nails. <b>Ceiling provides one hour fire resistance protection for trusses.</b></p>			<p>Approx. Ceiling Weight: 5 psf Fire Test: FM FC 172, 2-25-72; ITS, 8-6-98 Sound Test: Estimated</p>
GA FILE NO. FC 5410	GENERIC	1 HOUR FIRE	35 to 39 STC SOUND
<p style="text-align: center;"><b>WOOD JOISTS, GYPSUM WALLBOARD</b></p> <p>One layer 1/2" type X gypsum wallboard or gypsum veneer base applied at right angles to 2 x 10 wood joists 16" o.c. with 5d nails, 1 5/8" long, 0.099" shank, 1/4" heads, 6" o.c. Nails placed 3/4" from board edge joints and 1/2" from board end joints. Wood joists supporting 1" nominal T &amp; G wood subfloor and 1" nominal wood finish floor, or 19/32" plywood finished floor with long edges T &amp; G and 15/32" interior plywood with exterior glue subfloor perpendicular to joists with joints staggered.</p>			<p>Approx. Ceiling Weight: 2 psf Fire Test: UL R1319-66, 11-9-64, UL Design L512; UL R3501-45, 5-27-65, UL Design L522; UL R2717-38, 6-10-65, UL Design L503; UL R3543-6, 11-10-65, UL Design L519; ULC Design M502 Sound Test: NGC 4024, 7-13-66 IIC &amp; Test: 32 (66 C &amp; P) NGC 5032, 7-19-66</p>

<b>FLOOR-CEILING SYSTEMS, WOOD FRAMED</b>																											
<b>GA FILE NO. FC 5415</b>	<b>PROPRIETARY*</b>	<b>1 HOUR FIRE</b>	<b>35 to 39 STC SOUND</b>																								
<b>WOOD JOISTS, GYPSUM WALLBOARD, RESILIENT CHANNELS</b>																											
<p>One layer 5/8" proprietary type X gypsum wallboard or gypsum veneer base applied at right angles to resilient furring channels 16" o.c. with 1" Type S drywall screws 12" o.c. Gypsum board end joints located midway between continuous channels and attached to additional pieces of channel 72" long with screws 8" o.c. Resilient furring channels applied at right angles to 2 x 10 wood joists 24" o.c. with 6d coated nails, 17/8" long, 0.092" shank, 1/4" heads. Wood joists supporting 3/4" nominal interior plywood with exterior glue T &amp; G subfloor perpendicular to joists with joints staggered. Underside of T &amp; G joints covered between joist spaces with 6" x 22 1/2" x 5/8" type X gypsum wallboard battens attached to flooring with 16 gage x 1 1/8" legs x 1/2" crown staples spaced 7" o.c. along each edge.</p>																											
<p style="text-align: center;"><b>PROPRIETARY GYPSUM BOARD</b></p> <table border="0"> <tr> <td>American Gypsum Company LLC</td> <td>-</td> <td>5/8" FireBloc® Type C</td> </tr> <tr> <td>CertainTeed Gypsum Inc.</td> <td>-</td> <td>5/8" ProRoc® Type C Gypsum Panels</td> </tr> <tr> <td>Georgia-Pacific Gypsum LLC</td> <td>-</td> <td>5/8" ToughRock® Fireguard C™</td> </tr> <tr> <td>Lafarge North America Inc.</td> <td>-</td> <td>5/8" Firecheck® Type C</td> </tr> <tr> <td>National Gypsum Company</td> <td>-</td> <td>5/8" Gold Bond® Brand FIRE-SHIELD C™ Gypsum Board</td> </tr> <tr> <td>PABCO Gypsum</td> <td>-</td> <td>5/8" FLAME CURB® Super 'C'™</td> </tr> <tr> <td>Temple-Inland</td> <td>-</td> <td>5/8" TG-C</td> </tr> <tr> <td>United States Gypsum Company</td> <td>-</td> <td>5/8" SHEETROCK® Brand FIRECODE® C Core Gypsum Panels</td> </tr> </table>		American Gypsum Company LLC	-	5/8" FireBloc® Type C	CertainTeed Gypsum Inc.	-	5/8" ProRoc® Type C Gypsum Panels	Georgia-Pacific Gypsum LLC	-	5/8" ToughRock® Fireguard C™	Lafarge North America Inc.	-	5/8" Firecheck® Type C	National Gypsum Company	-	5/8" Gold Bond® Brand FIRE-SHIELD C™ Gypsum Board	PABCO Gypsum	-	5/8" FLAME CURB® Super 'C'™	Temple-Inland	-	5/8" TG-C	United States Gypsum Company	-	5/8" SHEETROCK® Brand FIRECODE® C Core Gypsum Panels	<p>Approx. Ceiling Weight: 2.5 psf                      Fire Test: UL R5229-2, 5-25-73, UL Design L513                      Sound Test: Estimated</p>	
American Gypsum Company LLC	-	5/8" FireBloc® Type C																									
CertainTeed Gypsum Inc.	-	5/8" ProRoc® Type C Gypsum Panels																									
Georgia-Pacific Gypsum LLC	-	5/8" ToughRock® Fireguard C™																									
Lafarge North America Inc.	-	5/8" Firecheck® Type C																									
National Gypsum Company	-	5/8" Gold Bond® Brand FIRE-SHIELD C™ Gypsum Board																									
PABCO Gypsum	-	5/8" FLAME CURB® Super 'C'™																									
Temple-Inland	-	5/8" TG-C																									
United States Gypsum Company	-	5/8" SHEETROCK® Brand FIRECODE® C Core Gypsum Panels																									
<b>GA FILE NO. FC 5420</b>	<b>GENERIC</b>	<b>1 HOUR FIRE</b>	<b>35 to 39 STC SOUND</b>																								
<b>WOOD JOISTS, GYPSUM WALLBOARD</b>																											
<p>One layer 5/8" type X gypsum wallboard or gypsum veneer base applied at right angles to 2 x 10 wood joists 16" o.c. with 6d coated nails, 17/8" long 0.0915" shank, 1/4" heads, 6" o.c. Wood joists supporting 1" nominal wood subfloor and 1" nominal wood finish floor, or 19/32" plywood finished floor with long edges T &amp; G and 15/32" interior plywood with exterior glue subfloor perpendicular to joists with joints staggered.</p>																											
		<p>Approx. Ceiling Weight: 2.5 psf                      Fire Test: UL R3501-5, 9, 7-15-52; UL R1319-2, 3, 6-5-52; UL Design L 501; ULC Design M500                      Sound Test: See FC 5410 (NGC 4024, 7-13-66)                      IIC &amp; Test: 32 (66 C &amp; P) NGC 5032, 7-19-66</p>																									
<b>GA FILE NO. FC 5470</b>	<b>GENERIC</b>	<b>1 HOUR FIRE</b>	<b>35 to 39 STC SOUND</b>																								
<b>WOOD JOISTS, GYPSUM LATH, GYPSUM PLASTER</b>																											
<p>5/8" 1:2 gypsum-perlite plaster applied over 3/8" type X gypsum lath applied at right angles to 2 x 10 wood joists 16" o.c. with either blued lath nails, 1 1/4" long, 13 gage shank, 9/32" heads or 16 gage staples, 1 1/2" long, 7/16" crown, four fasteners per lath at each joist. Wood joists supporting 1" nominal T &amp; G wood subfloor and 1" nominal wood finish floor.</p>																											
		<p>Approx. Ceiling Weight: 4 psf                      Fire Test: OSU T-2134-1,4-23-63                      Sound Test: Estimated</p>																									

\*Contact the manufacturer for more detailed information on proprietary products.

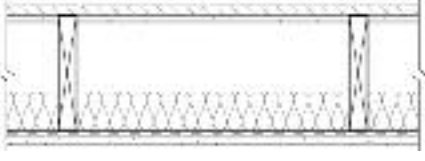
FLOOR-CEILING SYSTEMS, WOOD FRAMED				
GA FILE NO. FC 5490	GENERIC	1 HOUR FIRE	35 to 39 STC SOUND	<p align="center"><b>WOOD JOISTS, GYPSUM LATH, GYPSUM PLASTER</b></p> <p>1/2" 1:2 gypsum-sand plaster applied over 3/8" type X gypsum lath applied at right angles to 2 x 10 wood joists 16" o.c. with blued lath nails, 1 1/8" long, 0.0915" shank, 19/64" heads, 4 nails per lath at each joist. Continuous stripping supporting gypsum lath under each joist with 2.5 lb. steel strip lath or equivalent wire lath nailed with 11 gage, 1 1/2" long, 7/16" heads roofing nails, 6" o.c. Wood joists supporting 1" nominal T &amp; G wood subfloor and 1" nominal wood finish floor.</p>  <p>Approx. Ceiling Weight: 6 psf Fire Test: SFT-6, 2-6-60; SFT-8, 4-9-60; SFT-11, 10-4-60; SFT-12, 10-22-60; SFT-13, 1-7-61 Sound Test: Estimated</p>
GA FILE NO. FC 5506	PROPRIETARY*	1 HOUR FIRE		<p align="center"><b>WOOD JOISTS, GYPSUM WALLBOARD, RESILIENT CHANNELS</b></p> <p>One layer 5/8" type X gypsum wallboard or gypsum veneer base applied at right angles to resilient furring channels 12" o.c. with 1" Type S drywall screws 8" o.c. Gypsum board end joints located midway between continuous channels and attached to additional pieces of channel 53" long with screws 12" o.c. Resilient furring channels applied at right angles to 2 x 10 wood joists 16" o.c. with 1 1/4" Type S drywall screws. 3 1/2" glass or mineral fiber insulation loose-laid on resilient channels. Wood joists supporting 1" nominal T &amp; G wood subfloor and 1" nominal wood finish floor, or 5/8" plywood finished floor with long edges T &amp; G and 15/32" interior plywood with exterior glue subfloor perpendicular to joists with joints staggered.</p> <p align="center"><b>PROPRIETARY GYPSUM BOARD</b></p> <p>CertainTeed Gypsum Inc. - 5/8" ProRoc® Type C Gypsum Panels</p>  <p>Approx. Ceiling Weight: 3 psf Fire Test: UL R15187, 08NK13220, 7-30-08, UL Design L515</p>
GA FILE NO. FC 5507	PROPRIETARY*	1 HOUR FIRE		<p align="center"><b>WOOD JOISTS, GYPSUM WALLBOARD, RESILIENT CHANNELS</b></p> <p>One layer 5/8" type X gypsum wallboard or gypsum veneer base applied at right angles to resilient furring channels 12" o.c. with 1" Type S drywall screws 8" o.c. Gypsum board end joints located midway between continuous channels and attached to additional pieces of channel 72" long with screws 8" o.c. Resilient furring channels applied at right angles to 2 x 10 wood joists 24" o.c. with 1 1/4" Type S drywall screws. 3 1/2" glass or mineral fiber insulation loose-laid on resilient channels. Wood joists supporting 3/4" nominal interior plywood with exterior glue T &amp; G subfloor applied at right angles to joists with joints staggered. Underside of T &amp; G joints covered between joist spaces with 6" x 22 1/2" x 5/8" type X gypsum wallboard battens attached to flooring with 16 gage x 1 1/8" legs x 1/2" crown staples spaced 7" o.c. along each edge.</p> <p align="center"><b>PROPRIETARY GYPSUM BOARD</b></p> <p>CertainTeed Gypsum Inc. - 5/8" ProRoc® Type C Gypsum Panels</p>  <p>Approx. Ceiling Weight: 3 psf Fire Test: UL R15187, 08NK13220, 7-30-08, UL Design L513</p>

\*Contact the manufacturer for more detailed information on proprietary products.





**FLOOR-CEILING SYSTEMS, WOOD FRAMED****GA FILE NO. FC 5512****GENERIC****1 HOUR  
FIRE****GYPSUM BOARD, PARALLEL CHORD WOOD TRUSSES**

**CEILING:** **Base** layer 1/2" type X gypsum wallboard or gypsum veneer base applied perpendicular to wood trusses 24" o.c. with 1 1/4" Type S drywall screws 24" o.c. **Face** layer 1/2" type X gypsum wallboard or gypsum veneer base applied perpendicular to trusses with 1 7/8" Type S drywall screws 12" o.c. and 1 1/2" Type G drywall screws 12" o.c. placed 3" back from either side of end joints. Joints offset 24" from base layer joints.

**TRUSSES:** Chord and web members fabricated from 2 x 4 lumber with 20 gage steel connector plates having a minimum tooth length of 5/16". Plate design values based upon a safety factor of 4. Trusses have a minimum depth of 12".

**FLOORING:** 19/32" T & G plywood with exterior glue applied at right angles to top of trusses with 6d common nails 6" o.c. Plywood end joints staggered 48".

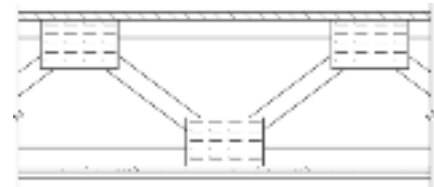

Approx. Ceiling

Weight: 4 psf

Fire Test: FM FC214 - 1 hour, 7-6-78

**GA FILE NO. FC 5513****GENERIC****1 HOUR  
FIRE****LIGHTWEIGHT CONCRETE, PLYWOOD, WOOD I-JOISTS,  
GYPSUM WALLBOARD**

**Base** layer 1/2" type X gypsum wallboard applied at right angles to minimum 9 1/2" deep wood I-joists, with minimum 1 1/4" deep x 1 1/2" wide flanges and minimum 3/8" webs, 24" o.c. with 1 5/8" Type W or S drywall screws 12" o.c. **Face** layer 1/2" type X gypsum wallboard applied at right angles to I-joists with 2" Type W or S drywall screws 12" o.c. at intermediate I-joists, 8" o.c. at end joints, and 1 1/2" Type G drywall screws 8" o.c. placed 6" back on either side of end joints. Joints offset 24" from base layer joints. Wood I-joists supporting 5/8" plywood with long edges T & G applied at right angles to I-joists with 8d common nails. 1 1/2" lightweight concrete poured over plywood.

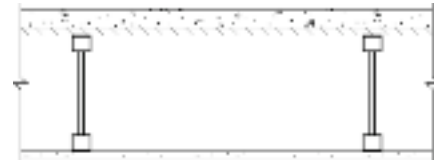

Approx. Ceiling

Weight: 5 psf

Fire Test: FM J.I. 2C9Q7.AC, 9-29-78,  
FM Design FC-268**GA FILE NO. FC 5514****PROPRIETARY\*****1 HOUR  
FIRE****WOOD TRUSSES, WOOD STRUCTURAL PANELS, GYPSUM  
FLOOR TOPPING, RESILIENT CHANNELS, GLASS FIBER  
INSULATION, CEILING DAMPER, GYPSUM WALLBOARD**

One layer 5/8" proprietary type X gypsum board or gypsum veneer base applied at right angles to resilient furring channels 12" o.c. with 1" Type S drywall screws 8" o.c. Gypsum board end joints attached with screws 8" o.c. to additional pieces of channel 60" long located 3" back on either side of end joint. Resilient channels applied at right angles to 18" deep parallel chord wood trusses 24" o.c. with 1 1/4" Type S or W screws. Glass fiber or mineral fiber batt or loose fill insulation applied directly over gypsum board. Trusses supporting 23/32" wood structural panel subfloor, long edges T & G, applied at right angles to trusses with construction adhesive and 6d ring shank nails 12" o.c. Either 3/4" gypsum floor topping or 15/32" wood structural panel underlayment applied over subfloor. Optional ceiling damper (refer to manufacturer for information on the type of damper).

**PROPRIETARY GYPSUM BOARD**

National Gypsum Company

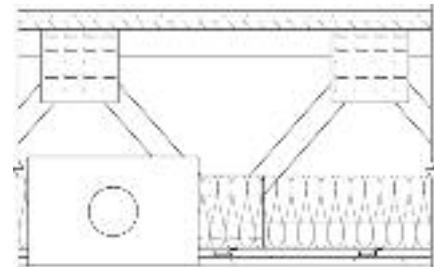
- 5/8" Gold Bond® Brand FIRE-SHIELD C™  
Gypsum Board

Approx. Ceiling

Weight: 3 psf

Fire Test: UL R3501, 00NK42686,  
8-16-01,  
UL Design L558;  
UL R5698, 4-11-01

\*Contact the manufacturer for more detailed information on proprietary products.

**FLOOR-CEILING SYSTEMS, WOOD FRAMED**

**GA FILE NO. FC 5515**

**PROPRIETARY\***

**1 HOUR  
FIRE**

**WOOD TRUSSES, GYPSUM WALLBOARD**

One layer 5/8" proprietary type X gypsum wallboard or gypsum veneer base applied at right angles to rigid furring channels 24" o.c. with 1" Type S drywall screws 12" o.c. and located a minimum of 1 1/2" from joints. Gypsum board end joints located midway between continuous channels and attached to additional pieces of channel 60" long with screws 12" o.c. Rigid furring channels applied at right angles to 12" deep parallel chord wood trusses 24" o.c. with double strand, 18 gage galvanized steel wire ties 48" o.c. Wood trusses supporting 3/4" nominal interior plywood with exterior glue, T & G edges, applied at right angles to trusses with construction adhesive and 6d ring shank nails 12" o.c. Adhesive applied to each top chord and grooved edges of plywood. End joints staggered 48".

Consult gypsum board manufacturer for truss details.

**PROPRIETARY GYPSUM BOARD**

- |                              |   |  |
|------------------------------|---|--|
| American Gypsum Company LLC  | - | 5/8" FireBloc® Type C                                |
| CertainTeed Gypsum Inc.      | - | 5/8" ProRoc® Type C Gypsum Panels                    |
| Georgia-Pacific Gypsum LLC   | - | 5/8" ToughRock® Fireguard C™                         |
| Lafarge North America Inc.   | - | 5/8" Firecheck® Type C                               |
| PABCO Gypsum                 | - | 5/8" FLAME CURB® Super 'C'™ Type C                   |
| Temple-Inland                | - | 5/8" TG-C  |
| United States Gypsum Company | - | 5/8" SHEETROCK® Brand FIRECODE® C Core Gypsum Panels |

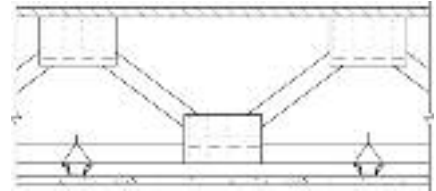

Approx. Ceiling Weight: 3 psf  
Fire Test: UL R9500-1, 80NK15492, 2-2-81; UL R2717-61, 8-18-87; UL Design L528

**GA FILE NO. FC 5516**

**PROPRIETARY\***

**1 HOUR  
FIRE**

**WOOD TRUSSES, GYPSUM WALLBOARD**

One layer 5/8" proprietary type X gypsum wallboard or gypsum veneer base applied at right angles to rigid furring channels 24" o.c. with 1" Type S drywall screws 12" o.c. and 1 1/2" from edges. Gypsum board end joints located midway between continuous channels and attached to additional pieces of channel 60" long with screws 12" o.c. Rigid furring channels applied at right angles to 12" deep parallel chord wood trusses 24" o.c. with double strand, 18 gage galvanized steel wire ties 48" o.c. Wood trusses supporting 3/4" nominal interior plywood with exterior glue, T&G edges, applied at right angles to trusses with construction adhesive and either 6d smooth shank nails 6" o.c. at end joints and 12" o.c. at intermediate trusses or 6d ring shank nails 12" o.c. Adhesive applied to each top chord and grooved edges of plywood. End joints staggered 48".

Consult gypsum board manufacturer for truss details.

**PROPRIETARY GYPSUM BOARD**

- |                         |   |   |
|-------------------------|---|---|
| National Gypsum Company | - | 5/8" Gold Bond® Brand FIRE-SHIELD C™ Gypsum Board |
|-------------------------|---|---|

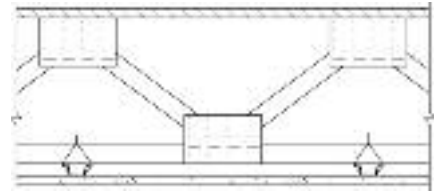

Approx. Ceiling Weight: 3 psf  
Fire Test: FM FC-448 (Method B), 2-24-88; Based on UL R3501, 11-27-89, UL Design L528

**GA FILE NO. FC 5517**

**PROPRIETARY\***

**1 HOUR  
FIRE**

**WOOD TRUSSES, GYPSUM WALLBOARD**

One layer 5/8" proprietary type X gypsum wallboard or gypsum veneer base applied at right angles to 12" deep parallel chord wood trusses 24" o.c. with 17/8" Type S drywall screws 8" o.c. to trusses and to 2 x 4 wood blocking installed between trusses, centered behind gypsum board edges and secured at each end to the trusses by nail attached 18 gage Z-shaped steel clips. Wood trusses supporting 5/8" nominal interior plywood with exterior glue, T & G edges, applied at right angles to trusses with construction adhesive and 6d smooth shank nails 12" o.c. in field and 6" o.c. along ends. Adhesive applied to each top chord and grooved edges of plywood. End joints staggered 48".

Consult gypsum board manufacturer for truss details.

**PROPRIETARY GYPSUM BOARD**

- |                         |   |   |
|-------------------------|---|---|
| National Gypsum Company | - | 5/8" Gold Bond® Brand FIRE-SHIELD C™ Gypsum Board |
|-------------------------|---|---|

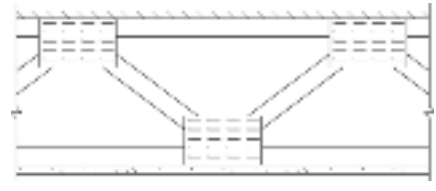

Approx. Ceiling Weight: 2.5 psf  
Fire Test: FM FC-442 (Method A), 2-17-88

*\*Contact the manufacturer for more detailed information on proprietary products.*

**FLOOR-CEILING SYSTEMS, WOOD FRAMED****GA FILE NO. FC 5519****PROPRIETARY\*****1 HOUR  
FIRE**

**WOOD TRUSSES, WOOD STRUCTURAL PANELS, GYPSUM  
FLOOR TOPPING, RESILIENT CHANNELS, GLASS OR MINERAL  
FIBER BATT OR LOOSE FILL INSULATION, CEILING DAMPER,  
GYPSUM WALLBOARD**

One layer 5/8" proprietary type X gypsum wallboard or gypsum veneer base applied at right angles to resilient furring channels 12" o.c. with 1" Type S drywall screws 8" o.c. Gypsum board end joints located midway between continuous channels and attached with screws 8" o.c. to additional pieces of channel 60" long located 3" back on either side of end joint. Resilient channels applied at right angles to 18" deep parallel chord wood trusses 24" o.c. with 1 1/4" Type S or W drywall screws. Glass or mineral fiber batt insulation stapled to subfloor or loose fill insulation applied directly over gypsum board. Wood trusses supporting 2 3/32" wood structural panel subfloor, long edges T&G, applied at right angles to trusses with 6d ring shank nails, or staples having equal or greater withdrawal and lateral resistance strength, 12" o.c. Either 3/4" gypsum floor topping or 1 5/32" wood structural panel underlayment applied over subfloor.

Optional ceiling damper (refer to manufacturer for information on the type of damper).

**PROPRIETARY GYPSUM BOARD**

American Gypsum Company LLC - 5/8" FireBloc® Type C  
Temple-Inland - 5/8" TG-C

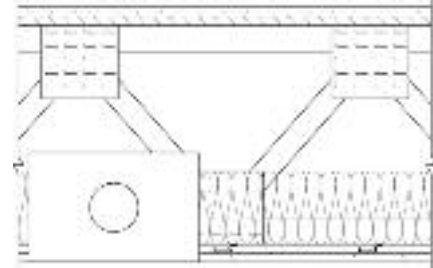

Approx. Ceiling

Weight:

3 psf

Fire Test:

UL R14196 (R6937),  
04NK25585, 1-15-05,  
UL Design L574

**GA FILE NO. FC 5520****PROPRIETARY\*****1 HOUR  
FIRE**

**WOOD TRUSSES, WOOD STRUCTURAL PANELS, GYPSUM  
FLOOR TOPPING, RESILIENT CHANNELS, GLASS OR MINERAL  
FIBER BATT OR LOOSE FILL INSULATION, CEILING DAMPER,  
GYPSUM WALLBOARD**

One layer 5/8" proprietary type X gypsum wallboard or gypsum veneer base applied at right angles to resilient furring channels 12" o.c. with 1" Type S drywall screws 9 5/8" o.c. Gypsum board end joints located midway between continuous channels and attached with screws 9 5/8" o.c. to additional pieces of channel 60" long located 3" back on either side of end joint. Resilient channels applied at right angles to 18" deep parallel chord wood trusses 24" o.c. with 1 1/4" Type S or W drywall screws. Glass or mineral fiber batt insulation stapled to subfloor or loose fill insulation applied directly over gypsum board. Wood trusses supporting 2 3/32" wood structural panel subfloor, long edges T&G, applied at right angles to trusses with 6d ring shank nails, or staples having equal or greater withdrawal and lateral resistance strength, 12" o.c. Either 3/4" gypsum floor topping or 1 5/32" wood structural panel underlayment applied over subfloor.

Optional ceiling damper (refer to manufacturer for information on the type of damper).

**PROPRIETARY GYPSUM BOARD**

PABCO Gypsum - 5/8" FLAME CURB® Type C

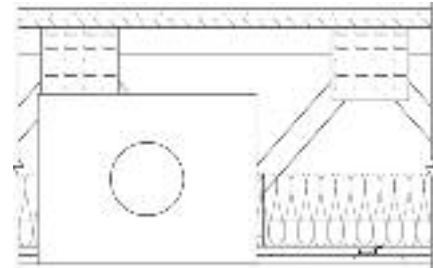

Approx. Ceiling

Weight:

3 psf

Fire Test:

UL R7094, 07NK11121,  
11-27-07,  
UL Design L592;  
WFCi 07002C/07048, 8-3-07

**GA FILE NO. FC 5521****PROPRIETARY\*****1 HOUR  
FIRE**

**WOOD TRUSSES, WOOD STRUCTURAL PANELS, GYPSUM  
FLOOR TOPPING, RESILIENT CHANNELS, GLASS OR MINERAL  
FIBER BATT OR LOOSE FILL INSULATION, CEILING DAMPER,  
GYPSUM WALLBOARD**

One layer 5/8" proprietary type X gypsum wallboard or gypsum veneer base applied at right angles to resilient furring channels 12" o.c. with 1" Type S drywall screws 9 5/8" o.c. Gypsum board end joints located midway between continuous channels and attached with screws 9 5/8" o.c. to additional pieces of channel 60" long located 3" back on either side of end joint. Resilient channels applied at right angles to 18" deep parallel chord wood trusses 24" o.c. with 1 1/4" Type S or W drywall screws. Glass or mineral fiber batt insulation stapled to subfloor or loose fill insulation applied directly over gypsum board. Wood trusses supporting 2 3/32" wood structural panel subfloor, long edges T&G, applied at right angles to trusses with 6d ring shank nails, or staples having equal or greater withdrawal and lateral resistance strength, 12" o.c. Either 3/4" gypsum floor topping or 1 5/32" wood structural panel underlayment applied over subfloor.

Optional ceiling damper (refer to manufacturer for information on the type of damper).

**PROPRIETARY GYPSUM BOARD**

CertainTeed Gypsum Inc. - 5/8" ProRoc® Type C Gypsum Panels

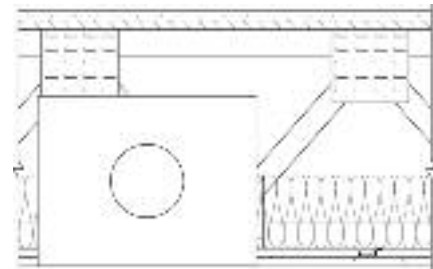

Approx. Ceiling

Weight:

3 psf

Fire Test:

UL R3660, 07NK25175,  
6-24-08,  
UL Design L562

*\*Contact the manufacturer for more detailed information on proprietary products.*

**FLOOR-CEILING SYSTEMS, WOOD FRAMED**

**GA FILE NO. FC 5522**

**GENERIC**

**1 HOUR  
FIRE**

**WOOD I-JOISTS, GYPSUM WALLBOARD,  
RESILIENT CHANNELS**

**Base** layer 1/2" type X gypsum wallboard applied at right angles to resilient channels 16" o.c. with 1 1/4" Type S drywall screws 12" o.c. Resilient channels applied at right angles to minimum 9 1/2" deep wood I-joists, with minimum 1 1/4" deep x 1 1/2" wide flanges and minimum 3/8" webs, 24" o.c. with 1 1/4" Type W drywall screws. **Face** layer 1/2" type X gypsum wallboard applied at right angles to channels with 1 5/8" Type S drywall screws 12" o.c. Face layer end joints located midway between channels and attached to base layer with 1 1/2" Type G screws 12" o.c. Edge joints offset 24" from base layer edge joints. Wood I-joists supporting 5/8" oriented strand board applied at right angles to I-joists with 8d common nails 12" o.c.

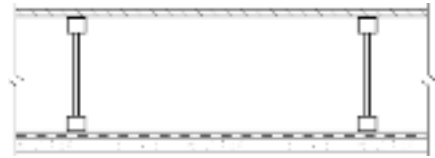

Approx. Ceiling  
Weight: 5 psf  
Fire Test: NRCC A-4440.1 (Revised),  
6-24-97

**GA FILE NO. FC 5523**

**GENERIC**

**1 HOUR  
FIRE**

**WOOD JOISTS, GYPSUM LATH, GYPSUM PLASTER,  
RESILIENT CHANNELS**

1/2" 1:2-1:3 gypsum-sand plaster applied over 3/8" type X gypsum lath applied at right angles to resilient furring channels 16" o.c. with three 3/4" Type S drywall screws at each channel 3" wide woven wire strips applied over gypsum lath and parallel to and directly over resilient channels with 7/8" Type S drywall screws with diamond washers 16" o.c. Resilient channels applied at right angles to 2 x 10 wood joists 16" o.c. with 6d coated nails, 1 7/8" long, 0.0915" shank, 1/4" heads. Wood joists supporting 1" nominal wood subfloor and 1" nominal wood finish floor.

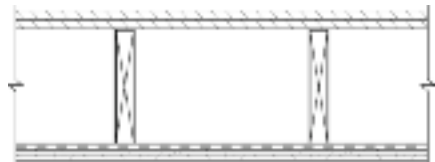

Approx. Ceiling  
Weight: 6.25 psf  
Fire Test: SFT-42, 5-7-66

**GA FILE NO. FC 5600**

**GENERIC**

**1 1/2 HOUR  
FIRE**

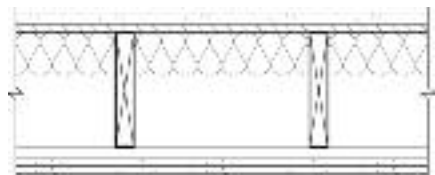

**WOOD JOISTS, GYPSUM WALLBOARD,  
GLASS FIBER INSULATION**

**Base** layer 5/8" type X gypsum wallboard or gypsum veneer base applied at right angles to rigid furring channels 16" o.c. with 1" Type S drywall screws 12" o.c. Gypsum board end joints located midway between continuous channels and attached to additional pieces of channel 60" long with 1" Type S drywall screws 8" o.c. Rigid furring channels applied at right angles to 2 x 10 wood joists 16" o.c. with 6d cooler or box nails, 1 7/8" long, 0.092" diameter shank, 1/4" heads, or 1 7/8" Type S drywall screws, two per joist. **Face** layer 5/8" type X gypsum wallboard or gypsum veneer base applied at right angles to furring channels with 1 7/8" Type S drywall screws 8" o.c. at end joints and 12" o.c. at intermediate channels. Edge joints staggered 18" minimum from base layer edge joints; end joints staggered 8" min. from base layer end joints. Wood joists supporting 5/8" interior plywood with exterior glue subfloor and 1 1/2" lightweight concrete reinforced with galvanized hexagonal wire mesh over film or felt or 1" sanded gypsum floor underlayment. 3 1/2" R-11 unfaced glass fiber insulation, 0.6 pcf, supported against subfloor by wire rods 12" o.c. Alternately, insulation may be 3 1/2" faced glass fiber insulation stapled in place against subfloor.

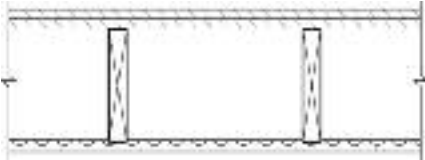
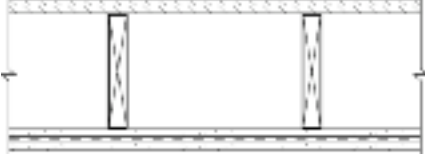

Approx. Ceiling  
Weight: 5 psf  
Fire Test: UL R4024-15, 8-31-84,  
UL Design L532

**FLOOR-CEILING SYSTEMS, WOOD FRAMED**

<p><b>GA FILE NO. FC 5610</b></p>	<p><b>GENERIC</b></p>	<p><b>1 3/4 HOUR FIRE</b></p>																								
<p><b>WOOD JOISTS, METAL LATH, GYPSUM PLASTER</b></p> <p>5/8" 1:2-1:3 gypsum-vermiculite plaster applied over 3.4 lb. metal lath applied to 2 x 10 wood joists 16" o.c. with barbed roofing nails, 1 1/2" long, 0.120" shank, 7/16" heads 5" o.c. Wood joists supporting 1" nominal T &amp; G wood subfloor and 1" nominal wood finish floor.</p>																										
		<p>Approx. Ceiling Weight: 4 psf Fire Test: NBS 272, 12-15-50</p>																								
<p><b>GA FILE NO. FC 5710</b></p>	<p><b>PROPRIETARY*</b></p>	<p><b>2 HOUR FIRE</b></p>																								
<p><b>WOOD FLOOR, WOOD JOISTS, GYPSUM WALLBOARD, RESILIENT CHANNELS</b></p> <p><b>Base</b> layer 5/8" proprietary type X gypsum wallboard applied at right angles to 2 x 10 wood joists 16" o.c. with 8d cement coated nails, 2 1/2" long, 0.113 shank, 19/64" heads, 7" o.c. Resilient channel 24" o.c. applied at right angles to wood framing through base layer with 1 7/8" long screws. Double channel installed at face layer end joints. <b>Face</b> layer 5/8" proprietary type X gypsum wallboard applied at right angles to resilient furring channels with 1" Type S screws 12" o.c. Wood joists supporting 1 5/32" plywood subfloor and 19/32" plywood finish floor applied at right angles to joists with joints staggered. Consult gypsum board manufacturer for other flooring options.</p> <p><b>PROPRIETARY GYPSUM BOARD</b></p> <table border="0"> <tr> <td>American Gypsum Company LLC</td> <td>-</td> <td>5/8" FireBloc® Type C</td> </tr> <tr> <td>CertainTeed Gypsum Inc.</td> <td>-</td> <td>5/8" ProRoc® Type C Gypsum Panels</td> </tr> <tr> <td>Georgia-Pacific Gypsum LLC</td> <td>-</td> <td>5/8" ToughRock® Fireguard C™</td> </tr> <tr> <td>Lafarge North America Inc.</td> <td>-</td> <td>5/8" Firecheck® Type C</td> </tr> <tr> <td>National Gypsum Company</td> <td>-</td> <td>5/8" Gold Bond® Brand FIRE-SHIELD C™ Gypsum Board</td> </tr> <tr> <td>PABCO Gypsum</td> <td>-</td> <td>5/8" FLAME CURB® Super 'C'™</td> </tr> <tr> <td>Temple-Inland</td> <td>-</td> <td>5/8" TG-C</td> </tr> <tr> <td>United States Gypsum Company</td> <td>-</td> <td>5/8" SHEETROCK® Brand FIRECODE® C Core Gypsum Panels</td> </tr> </table>		American Gypsum Company LLC	-	5/8" FireBloc® Type C	CertainTeed Gypsum Inc.	-	5/8" ProRoc® Type C Gypsum Panels	Georgia-Pacific Gypsum LLC	-	5/8" ToughRock® Fireguard C™	Lafarge North America Inc.	-	5/8" Firecheck® Type C	National Gypsum Company	-	5/8" Gold Bond® Brand FIRE-SHIELD C™ Gypsum Board	PABCO Gypsum	-	5/8" FLAME CURB® Super 'C'™	Temple-Inland	-	5/8" TG-C	United States Gypsum Company	-	5/8" SHEETROCK® Brand FIRECODE® C Core Gypsum Panels	
American Gypsum Company LLC	-	5/8" FireBloc® Type C																								
CertainTeed Gypsum Inc.	-	5/8" ProRoc® Type C Gypsum Panels																								
Georgia-Pacific Gypsum LLC	-	5/8" ToughRock® Fireguard C™																								
Lafarge North America Inc.	-	5/8" Firecheck® Type C																								
National Gypsum Company	-	5/8" Gold Bond® Brand FIRE-SHIELD C™ Gypsum Board																								
PABCO Gypsum	-	5/8" FLAME CURB® Super 'C'™																								
Temple-Inland	-	5/8" TG-C																								
United States Gypsum Company	-	5/8" SHEETROCK® Brand FIRECODE® C Core Gypsum Panels																								
		<p>Approx. Ceiling Weight: 6 psf Fire Test: UL R1319-114, 7-21-67, UL Design L511</p>																								
<p><b>GA FILE NO. FC 5724</b></p>	<p><b>PROPRIETARY*</b></p>	<p><b>2 HOUR FIRE</b></p>																								
<p><b>WOOD FLOOR, WOOD JOISTS, GYPSUM WALLBOARD, RESILIENT CHANNELS</b></p> <p><b>Base</b> layer 5/8" proprietary type X gypsum wallboard or gypsum veneer base applied at right angles to 2 x 10 wood joists 16" o.c. with 8d nails, 2 1/2" long, 0.113" shank, 19/64" heads, 7" o.c. Resilient furring channels 24" o.c. applied at right angles to joists through base layer with one 8d nail, 2 1/2" long, 0.113" shank, 19/64" head, at each joist. <b>Face</b> layer 5/8" proprietary type X gypsum wallboard or gypsum veneer base applied at right angles to resilient furring channels with 1" Type S drywall screws 12" o.c. Double channel installed at face layer end joints. Wood joists supporting 1" nominal T &amp; G wood subfloor and 1" nominal wood finish floor or 19/32" plywood finished floor with long edges T &amp; G and 15/32" interior plywood with exterior glue subfloor perpendicular to joists with joints staggered.</p> <p><b>PROPRIETARY GYPSUM BOARD</b></p> <table border="0"> <tr> <td>American Gypsum Company LLC</td> <td>-</td> <td>5/8" FireBloc® Type C</td> </tr> <tr> <td>CertainTeed Gypsum Inc.</td> <td>-</td> <td>5/8" ProRoc® Type C Gypsum Panels</td> </tr> <tr> <td>Georgia-Pacific Gypsum LLC</td> <td>-</td> <td>5/8" ToughRock® Fireguard C™</td> </tr> <tr> <td>Lafarge North America Inc.</td> <td>-</td> <td>5/8" Firecheck® Type C</td> </tr> <tr> <td>National Gypsum Company</td> <td>-</td> <td>5/8" Gold Bond® Brand FIRE-SHIELD C™ Gypsum Board</td> </tr> <tr> <td>PABCO Gypsum</td> <td>-</td> <td>5/8" FLAME CURB® Super 'C'™</td> </tr> <tr> <td>Temple-Inland</td> <td>-</td> <td>5/8" TG-C</td> </tr> </table>		American Gypsum Company LLC	-	5/8" FireBloc® Type C	CertainTeed Gypsum Inc.	-	5/8" ProRoc® Type C Gypsum Panels	Georgia-Pacific Gypsum LLC	-	5/8" ToughRock® Fireguard C™	Lafarge North America Inc.	-	5/8" Firecheck® Type C	National Gypsum Company	-	5/8" Gold Bond® Brand FIRE-SHIELD C™ Gypsum Board	PABCO Gypsum	-	5/8" FLAME CURB® Super 'C'™	Temple-Inland	-	5/8" TG-C				
American Gypsum Company LLC	-	5/8" FireBloc® Type C																								
CertainTeed Gypsum Inc.	-	5/8" ProRoc® Type C Gypsum Panels																								
Georgia-Pacific Gypsum LLC	-	5/8" ToughRock® Fireguard C™																								
Lafarge North America Inc.	-	5/8" Firecheck® Type C																								
National Gypsum Company	-	5/8" Gold Bond® Brand FIRE-SHIELD C™ Gypsum Board																								
PABCO Gypsum	-	5/8" FLAME CURB® Super 'C'™																								
Temple-Inland	-	5/8" TG-C																								
		<p>Approx. Ceiling Weight: 6 psf Fire Test: UL R2717-35, 10-21-64, UL Design L505; ULC Design M503</p>																								

*\*Contact the manufacturer for more detailed information on proprietary products.*

**FLOOR-CEILING SYSTEMS, WOOD FRAMED**

**GA FILE NO. FC 5725**

**GENERIC**

**2 HOUR  
FIRE**

**WOOD FLOOR, WOOD JOISTS, GYPSUM WALLBOARD,  
RIGID FURRING CHANNELS**

**Base** layer 5/8" type X gypsum wallboard applied at right angles to 2 x 8 wood joists 24" o.c. with 1 1/4" Type W drywall screws 12" o.c. **Second** layer 5/8" type X gypsum wallboard applied at right angles to joists with 2" Type W drywall screws 12" o.c. Second layer joints offset 24" from base layer joints. **Third** layer 5/8" type X gypsum wallboard applied at right angles to joists with 2 1/2" Type W drywall screws 12" o.c. Third layer joints offset 12" from second layer joints. Hat-shaped rigid furring channels 24" o.c. applied at right angles to joists over third layer with two 2 1/2" long Type W drywall screws at each joist. **Face** layer 5/8" type X gypsum wallboard applied at right angles to furring channels with 1 1/8" Type S drywall screws 12" o.c. Wood joists supporting 3/4" T & G edge plywood floor applied at right angles to joists with 8d nails 6" o.c. at joints and 12" at intermediate joists. **Ceiling provides two-hour fire-resistance protection for wood framing.**

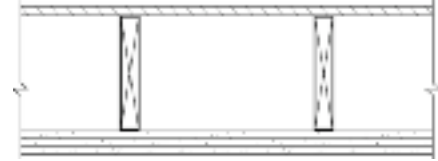

Approx. Ceiling Weight: 12 psf  
Fire Test: UL R4024, 00NK26545, 4-27-01; UL R4024, 03NK11206, 3-19-03; UL Design L556; ULC Design M514

**GA FILE NO. FC 5750**

**GENERIC**

**2 HOUR  
FIRE**

**WOOD FLOOR, WOOD I-JOISTS, GYPSUM WALLBOARD,  
RIGID FURRING CHANNELS**

**Base** layer 5/8" type X gypsum wallboard applied at right angles to 9 1/2" deep wood I-joists 24" o.c. with 1 1/4" Type W drywall screws 12" o.c. **Second** layer 5/8" type X gypsum wallboard applied at right angles to I-joists with 2" Type W drywall screws 12" o.c. Second layer joints offset 24" from base layer joints. **Third** layer 5/8" type X gypsum wallboard applied at right angles to I-joists with 2 1/2" Type W drywall screws 12" o.c. Third layer joints offset 12" from second layer joints. Hat-shaped rigid furring channels 24" o.c. applied at right angles to I-joists over third layer with two 2 1/2" long Type W drywall screws at each I-joist. **Face** layer 5/8" type X gypsum wallboard applied at right angles to furring channels with 1 1/8" Type S drywall screws 12" o.c. Wood I-joists supporting 3/4" T & G edge plywood floor applied at right angles to I-joists with 8d nails 6" o.c. at joints and 12" at intermediate I-joists. **Ceiling provides two-hour fire-resistance protection for wood framing.**

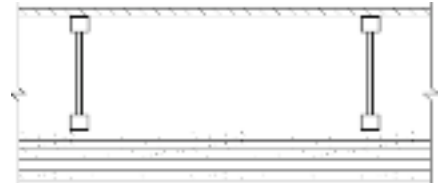

Approx. Ceiling Weight: 12 psf  
Fire Test: UL R4024, 00NK26545, 4-27-01, UL Design L556; ULC Design M514

**GA FILE NO. FC 5751**

**GENERIC**

**2 HOUR  
FIRE**

**WOOD FLOOR, WOOD TRUSSES, GYPSUM WALLBOARD,  
RIGID FURRING CHANNELS**

**Base** layer 5/8" type X gypsum wallboard applied at right angles to 18" deep parallel chord wood 24" o.c. with 1 1/4" Type W drywall screws 12" o.c. **Second** layer 5/8" type X gypsum wallboard applied at right angles to trusses with 2" Type W drywall screws 12" o.c. Second layer joints offset 24" from base layer joints. **Third** layer 5/8" type X gypsum wallboard applied at right angles to trusses with 2 1/2" Type W drywall screws 12" o.c. Third layer joints offset 12" from second layer joints. Hat-shaped rigid furring channels 24" o.c. applied at right angles to trusses over third layer with two 2 1/2" long Type W drywall screws at each truss. **Face** layer 5/8" type X gypsum wallboard applied at right angles to furring channels with 1 1/8" Type S drywall screws 12" o.c. Wood trusses supporting 3/4" T & G edge plywood floor applied at right angles to trusses with 8d nails 6" o.c. at joints and 12" at intermediate trusses. **Ceiling provides two-hour fire-resistance protection for wood framing.**

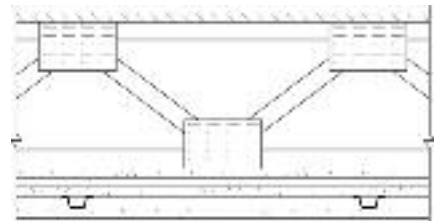

Approx. Ceiling Weight: 12 psf  
Fire Test: UL R4024, 00NK26545, 4-27-01, UL Design L556; ULC Design M514

**FLOOR-CEILING SYSTEMS, WOOD FRAMED**

**GA FILE NO. FC 5752**

**PROPRIETARY\***

**2 HOUR  
FIRE**

**WOOD TRUSSES, WOOD STRUCTURAL PANELS, GYPSUM  
FLOOR TOPPING, RESILIENT CHANNELS, GLASS OR MINERAL  
FIBER BATT OR LOOSE FILL INSULATION, GYPSUM  
WALLBOARD**

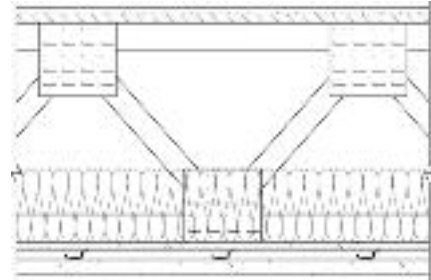

Approx. Ceiling  
Weight: 3 psf  
Fire Test: UL R5698, 05NK20716,  
8-10-05,  
UL Design L577

**Base** layer 5/8" proprietary type X gypsum wallboard or gypsum veneer base applied at right angles to minimum 12" deep parallel chord wood trusses 24" o.c. with 1 5/8" Type S drywall screws 8" o.c. Resilient channels 16" o.c. applied at right angles to trusses with 1 7/8" Type S drywall screws to each truss. **Second** layer 5/8" proprietary type X gypsum wallboard or gypsum veneer base applied at right angles to resilient channels with end joints centered on channels with 1" Type S-12 drywall screws 8" o.c. **Face** layer 5/8" proprietary type X gypsum wallboard or gypsum veneer base applied at right angles to channels with 1 5/8" Type S-12 drywall screws 8" o.c. Face layer joints offset 16" from second layer joints. Glass or mineral fiber batt, blanket, or loose-fill insulation applied directly over gypsum board. Wood trusses supporting 2 3/32" nominal wood structural panel subfloor applied at right angles to trusses with construction adhesive and 6d ring shank nails 12" o.c. Minimum 1/2" proprietary gypsum floor topping applied over subfloor.

**PROPRIETARY GYPSUM COMPONENTS**

- United States Gypsum Company - 5/8" SHEETROCK® Brand FIRECODE® C Core Gypsum Panels
- LEVELROCK® Brand Floor Underlayment

**This Space Left Blank**

*\*Contact the manufacturer for more detailed information on proprietary products.*

**ROOF-CEILING SYSTEMS**

**GA FILE NO. RC 2501**

**PROPRIETARY\***

**1 HOUR  
FIRE**

**STEEL ROOF TRUSSES, RESILIENT OR RIGID CHANNELS,  
THERMAL INSULATION, GYPSUM WALLBOARD**

One layer 5/8" proprietary type X gypsum wallboard or gypsum veneer base applied at right angles to resilient or rigid furring channels with 1 1/8" Type S drywall screws 12" o.c. Channels spaced 12" o.c. when insulation is used or 16" o.c. when no insulation is used. Gypsum board end joints attached with screws 12" o.c. to additional pieces of channel 60" long located 3" back on either side of end joint. Resilient channels applied at right angles to bottom chord of pitched or parallel chord steel trusses 48" o.c. with 1/2" Type S-12 screws or rigid furring channels secured to the bottom chord of each truss with double-strand wire saddle ties (**refer to furring channel manufacturer for maximum spans**). Optional glass fiber or mineral fiber batt or loose fill insulation applied directly over gypsum board. Trusses supporting metal roof deck panels covered by 1/2" regular gypsum sheathing either loose laid, or adhesively or mechanically attached to roof deck. Any thickness polyisocyanurate foamed plastic; polystyrene foamed plastic; or mineral fiber or glass fiber insulation boards laid over gypsum sheathing and covered by a Class A, B, or C roof covering.

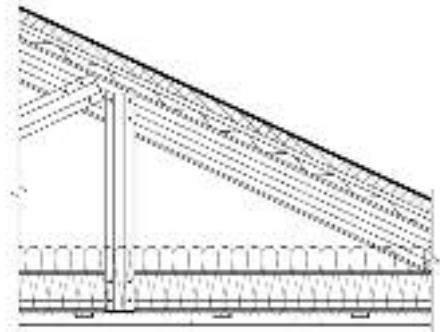

**PROPRIETARY GYPSUM BOARD**

National Gypsum Company - 5/8" Gold Bond® Brand FIRE-SHIELD C™ Gypsum Board

Approx. Ceiling Weight: 3 psf  
Fire Test: UL R3501, 01NK49664, 9-5-02, UL Design P540

**GA FILE NO. RC 2502**

**PROPRIETARY\***

**1 HOUR  
FIRE**

**STEEL ROOF TRUSSES, RESILIENT OR RIGID CHANNELS,  
THERMAL INSULATION, GYPSUM WALLBOARD**

One layer 5/8" proprietary type X gypsum wallboard applied at right angles to resilient or rigid furring channels with 1" Type S drywall screws 12" o.c. Channels spaced 12" o.c. when insulation is used or 16" o.c. when no insulation is used. Gypsum board end joints attached with screws 12" o.c. to additional pieces of channel 60" long located 3" back on either side of end joint. Resilient channels applied at right angles to bottom chord of pitched or parallel chord steel trusses 48" o.c. with 1/2" Type S-12 screws or rigid furring channels secured to the bottom chord of each truss with double-strand wire saddle ties (**refer to furring channel manufacturer for maximum spans**). Optional glass fiber or mineral fiber batt or loose fill insulation applied directly over gypsum board. Trusses supporting metal roof deck panels covered by 1/2" or 5/8" cement backer board or 1/2" regular gypsum sheathing either loose laid, or adhesively or mechanically attached to roof deck. Any thickness polyisocyanurate foamed plastic; polystyrene foamed plastic; or mineral fiber or glass fiber insulation boards laid over gypsum sheathing and covered by a Class A, B, or C roof covering.

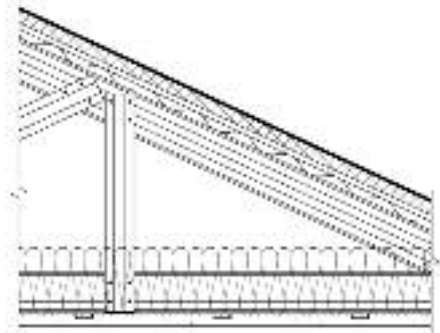

**PROPRIETARY GYPSUM BOARD**

American Gypsum Company LLC - 5/8" FireBloc® Type C  
Temple-Inland - 5/8" TG-C

Approx. Ceiling Weight: 3 psf  
Fire Test: UL R14196, 07NK19575, 2-15-08; UL R6937, 08NK02787, 9-19-08; UL Design P550

**GA FILE NO. RC 2601**

**GENERIC**

**1 HOUR  
FIRE**

**GYPSUM WALLBOARD, WOOD JOISTS, ROOF COVERING**

**Base** layer 5/8" type X gypsum wallboard applied at right angles to 2 x 10 wood joists 24" o.c. with 1 1/4" Type W or S drywall screws 24" o.c. **Face** layer 5/8" type X gypsum wallboard or gypsum veneer base applied at right angles to joists with 1 7/8" Type W or S drywall screws 12" o.c. at joints and intermediate joists and 1 1/2" Type G drywall screws 12" o.c. placed 2" back on either side of end joints. Joints offset 24" from base layer joints. Wood joists supporting 1/2" plywood with exterior glue applied at right angles to joists with 8d nails. Appropriate roof covering. **Ceiling provides one hour fire resistance protection for framing, including trusses.**



Approx. Ceiling Weight: 5 psf  
Fire Test: FM FC 172, 2-25-72; ITS, 8-6-98

\*Contact the manufacturer for more detailed information on proprietary products.

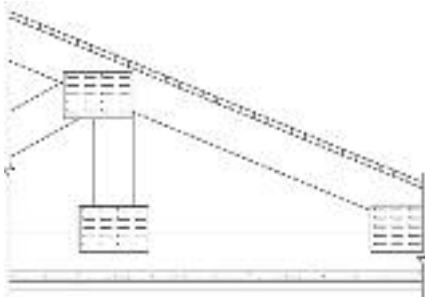

**ROOF-CEILING SYSTEMS**

<b>GA FILE NO. RC 2602</b>	<b>GENERIC</b>	<b>1 HOUR FIRE</b>
<b>WOOD TRUSSES, GYPSUM WALLBOARD</b>		
<p><b>Base</b> layer 5/8" type X gypsum wallboard applied at right angles to wood roof trusses 24" o.c. with 1 1/4" Type W or S drywall screws 24" o.c. <b>Face</b> layer 5/8" type X gypsum wallboard or gypsum veneer base applied at right angles to trusses with 1 7/8" Type W or S drywall screws 12" o.c. at joints and intermediate trusses and 1 1/2" Type G drywall screws 12" o.c. placed 2" back on either side of end joints. Joints offset 24" from base layer joints. Wood trusses supporting 1/2" wood structural panels applied at right angles to trusses with 8d nails. Appropriate roof covering. <b>Ceiling provides one hour fire resistance protection for trusses.</b></p>		
		<p>Approx. Ceiling Weight: 5 psf Fire Test: FM FC 172, 2-25-72; ITS, 8-6-98</p>

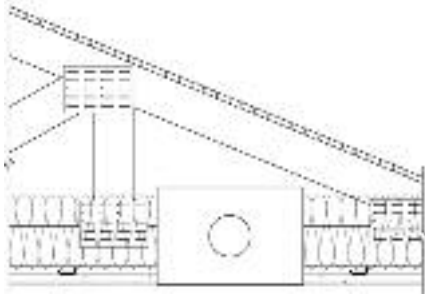
<b>GA FILE NO. RC 2603</b>	<b>PROPRIETARY*</b>	<b>1 HOUR FIRE</b>
<b>WOOD ROOF TRUSSES, RESILIENT CHANNELS, GLASS OR MINERAL FIBER INSULATION, CEILING DAMPER, GYPSUM WALLBOARD</b>		
<p>One layer 5/8" proprietary type X gypsum wallboard or gypsum veneer base applied at right angles to resilient furring channels 12" o.c. with 1 1/8" Type S drywall screws 8" o.c. Gypsum board end joints attached with screws 8" o.c. to additional pieces of channel 60" long located 3" back on either side of end joint. Resilient channels applied at right angles to bottom chord of pitched wood trusses 24" o.c. with 1 1/4" Type S or W screws. Glass fiber or mineral fiber batt or loose fill insulation applied directly over gypsum board. Trusses supporting 1 5/32" plywood or OSB roof sheathing applied at right angles to trusses with construction adhesive and 6d ring shank nails 12" o.c. Optional ceiling damper (refer to manufacturer for information on the type of damper).</p>		
<p style="text-align: center;"><b>PROPRIETARY GYPSUM BOARD</b></p> <p>National Gypsum Company - 5/8" Gold Bond® Brand FIRE-SHIELD C™ Gypsum Board</p>		<p>Approx. Ceiling Weight: 3 psf Fire Test: UL R3501, 00NK42686, 8-16-01, UL Design P533</p>

*\*Contact the manufacturer for more detailed information on proprietary products.*

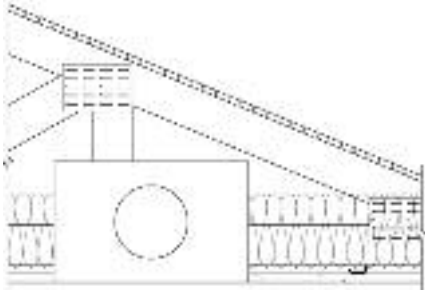
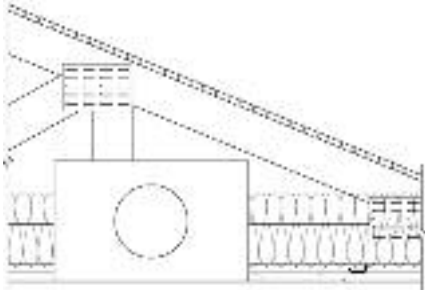
<b>ROOF-CEILING SYSTEMS</b>		
<b>GA FILE NO. RC 2604</b>	<b>PROPRIETARY*</b>	<b>1 HOUR FIRE</b>
<p style="text-align: center;"><b>WOOD ROOF TRUSSES, RESILIENT CHANNELS, GLASS FIBER INSULATION, CEILING DAMPER, GYPSUM WALLBOARD</b></p> <p>One layer 5/8" proprietary type X gypsum wallboard or gypsum veneer base applied at right angles to resilient furring channels 16" o.c. (12" o.c. when insulation is draped over channels) with 1" Type S drywall screws 12" o.c. Gypsum board end joints attached with screws 8" o.c. to additional pieces of channel 60" long located 3" back on either side of end joint. Resilient channels applied at right angles to bottom chord of pitched wood trusses 24" o.c. with 1 1/4" Type S or W screws. Glass fiber insulation secured to wood structural panels or draped over channels. Trusses supporting 1 5/32" wood structural panels applied at right angles to trusses with construction adhesive and 6d ring shank nails 12" o.c. Optional ceiling damper (refer to manufacturer for information on the type of damper).</p> <p style="text-align: center;"><b>PROPRIETARY GYPSUM BOARD</b></p> <p>United States Gypsum Company                      - 5/8" SHEETROCK® Brand FIRECODE® C Core Gypsum Panels</p>		 <p>Approx. Ceiling Weight: 3 psf Fire Test: UL R15858, 02NK24136, 3-20-03, UL Design P544; UL R15858, 02NK41925, 9-30-02, UL Design P531; UL R1319, 98NK41378, 11-20-98, UL Design P522</p>
<b>GA FILE NO. RC 2606</b>	<b>PROPRIETARY*</b>	<b>1 HOUR FIRE</b>
<p style="text-align: center;"><b>WOOD ROOF TRUSSES, RESILIENT CHANNELS, GLASS OR MINERAL FIBER INSULATION, CEILING DAMPER, GYPSUM WALLBOARD</b></p> <p>One layer 5/8" proprietary type X gypsum wallboard or gypsum veneer base applied at right angles to resilient furring channels 12" o.c. with 1 1/8" Type S drywall screws 8" o.c. Gypsum board end joints attached with screws 8" o.c. to additional pieces of channel 60" long located 3" back on either side of end joint. Resilient channels applied at right angles to bottom chord of pitched wood trusses 24" o.c. with 1 1/4" Type S or W screws. Glass fiber or mineral fiber batt or loose fill insulation applied directly over gypsum board. Trusses supporting 1 5/32" plywood or OSB roof sheathing applied at right angles to trusses with 6d ring shank nails 12" o.c. Optional ceiling damper (refer to manufacturer for information on the type of damper).</p> <p style="text-align: center;"><b>PROPRIETARY GYPSUM BOARD</b></p> <p>American Gypsum Company LLC                      - 5/8" FireBloc® Type C Temple-Inland    - 5/8" TG-C</p>		 <p>Approx. Ceiling Weight: 3 psf Fire Test: UL R14196 (R6937) 04NK25585, 1-15-05, UL Design P545</p>

*\*Contact the manufacturer for more detailed information on proprietary products.*

## ROOF-CEILING SYSTEMS

**GA FILE NO. RC 2608**
**PROPRIETARY\***
**1 HOUR  
FIRE**
**WOOD ROOF TRUSSES, RESILIENT CHANNELS, GLASS OR  
MINERAL FIBER INSULATION, CEILING DAMPER, GYPSUM  
WALLBOARD**

One layer 5/8" proprietary type X gypsum wallboard or gypsum veneer base applied at right angles to resilient furring channels 16" o.c. (12" o.c. when insulation is draped over channels) with 1" Type S drywall screws 12" o.c. (9 5/8" o.c. when insulation is draped over channels). Gypsum board end joints attached with screws 8" o.c. to additional pieces of channel 60" long located 3" back on either side of end joint. Resilient channels applied at right angles to bottom chord of pitched wood trusses 24" o.c. with 1 1/4" Type S or W screws. Optional glass fiber or mineral fiber batt insulation secured to wood structural panels or applied directly over gypsum board. Trusses supporting 2 3/32" wood structural panels applied at right angles to trusses with either 6d ring shank nails or staples having equal or greater withdrawal and lateral resistance strength. Optional ceiling damper (refer to manufacturer for information on the type of damper).

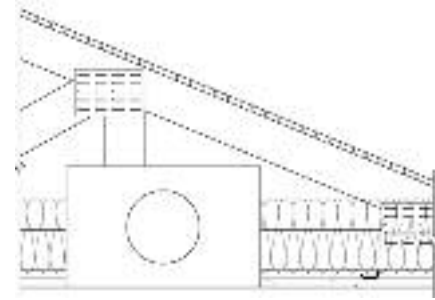

Approx. Ceiling

Weight: 3 psf

 Fire Test: UL R7094, 07NK11121,  
11-27-07, UL Design P549;  
WFCi 07002C/07048, 8-3-07

PABCO Gypsum

**PROPRIETARY GYPSUM BOARD**

-

5/8" FLAMECURB® Type C

**GA FILE NO. RC 2609**
**PROPRIETARY\***
**1 HOUR  
FIRE**
**WOOD ROOF TRUSSES, RESILIENT CHANNELS, GLASS FIBER  
INSULATION, CEILING DAMPER, GYPSUM WALLBOARD**

One layer 5/8" proprietary type X gypsum wallboard or gypsum veneer base applied at right angles to resilient furring channels 16" o.c. (12" o.c. when insulation is draped over channels or sprayed directly over gypsum board) with 1" Type S drywall screws 12" o.c. (9 5/8" o.c. when insulation is draped over channels). Gypsum board end joints attached with screws 8" o.c. to additional pieces of channel 60" long located 3" back on either side of end joint. Resilient channels applied at right angles to bottom chord of pitched wood trusses 24" o.c. with 1 1/4" Type S or W screws. Optional glass fiber insulation secured to wood structural panels or draped over channels, or cellulose insulation sprayed directly over gypsum board. Trusses supporting 1 5/32" wood structural panels applied at right angles to trusses with either construction adhesive and 6d ring shank nails 12" o.c. Optional ceiling damper (refer to manufacturer for information on the type of damper).

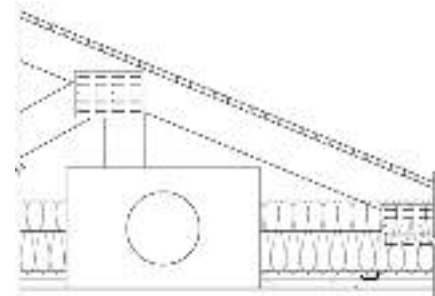

Approx. Ceiling

Weight: 3 psf

 Fire Test: UL R3660, 07NK25175,  
6-24-08,  
UL Design P538

CertainTeed Gypsum Inc.

**PROPRIETARY GYPSUM BOARD**

-

5/8" ProRoc® Type C Gypsum Panels

**GA FILE NO. RC 2750**
**GENERIC**
**2 HOUR  
FIRE**
**GYPSUM WALLBOARD, RIGID FURRING CHANNELS  
WOOD JOISTS or WOOD I-JOISTS, ROOF COVERING**

**Base** layer 5/8" type X gypsum wallboard applied at right angles to either 2 x 8 wood joists or 9 1/2" deep wood I-joists 24" o.c. with 1 1/4" Type W drywall screws 12" o.c. **Second** layer 5/8" type X gypsum wallboard applied at right angles to joists or I-joists with 2" Type W drywall screws 12" o.c. Second layer joints offset 24" from base layer joints. **Third** layer 5/8" type X gypsum wallboard applied at right angles to joists or I-joists with 2 1/2" Type W drywall screws 12" o.c. Third layer joints offset 12" from second layer joints. Hat-shaped rigid furring channels 24" o.c. applied at right angles to joists or I-joists over third layer with two 2 1/2" long Type W drywall screws at each joist or I-joist. **Face** layer 5/8" type X gypsum wallboard applied at right angles to furring channels with 1 1/8" Type S drywall screws 12" o.c. Wood joists or I-joists supporting 3/4" T & G edge plywood applied at right angles to joists or I-joists with 8d nails 6" o.c. at joints and 12" at intermediate joists or I-joists. Appropriate roof covering. **Ceiling provides two-hour fire-resistance protection for wood framing.**

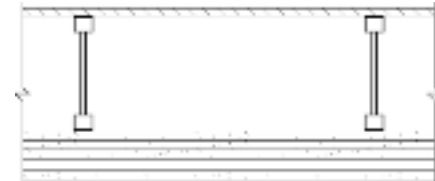

Approx. Ceiling

Weight: 12 psf

 Fire Test: UL R4024, 00NK26545,  
4-27-01;  
UL R4042, 03NK11206,  
3-19-03;  
UL Design L556;  
ULC Design M514

*\*Contact the manufacturer for more detailed information on proprietary products.*

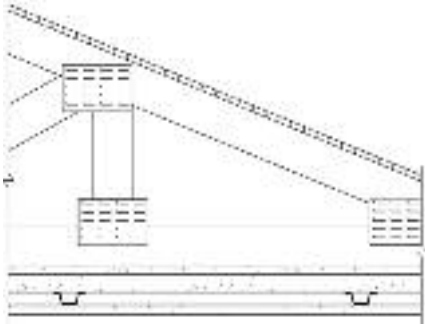
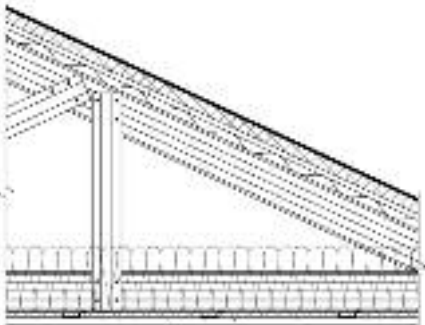
<b>ROOF-CEILING SYSTEMS</b>		
<b>GA FILE NO. RC 2751</b>	<b>GENERIC</b>	<b>2 HOUR FIRE</b>
<p><b>WOOD ROOF TRUSSES, GYPSUM WALLBOARD, RIGID FURRING CHANNELS</b></p> <p><b>Base</b> layer 5/8" type X gypsum wallboard applied at right angles to wood roof trusses 24" o.c. with 1 1/4" Type W drywall screws 12" o.c. <b>Second</b> layer 5/8" type X gypsum wallboard applied at right angles to trusses with 2" Type W drywall screws 12" o.c. Second layer joints offset 24" from base layer joints. <b>Third</b> layer 5/8" type X gypsum wallboard applied at right angles to trusses with 2 1/2" Type W drywall screws 12" o.c. Third layer joints offset 12" from second layer joints. Hat-shaped rigid furring channels 24" o.c. applied at right angles to trusses over third layer with two 2 1/2" long Type W drywall screws at each truss. <b>Face</b> layer 5/8" type X gypsum wallboard applied at right angles to furring channels with 1 1/8" Type S drywall screws 12" o.c. Wood trusses supporting 3/4" T &amp; G edge wood structural panels applied at right angles to trusses with 8d nails 6" o.c. at joints and 12" at intermediate l-joists. Appropriate roof covering. <b>Ceiling provides two-hour fire-resistance protection for wood framing.</b></p>		
		<p>Approx. Ceiling Weight: 12 psf Fire Test: UL R4024, 00NK26545, 4-27-01, UL Design L556; ULC Design M514</p>
<b>GA FILE NO. RC 2752</b>	<b>PROPRIETARY*</b>	<b>2 HOUR FIRE</b>
<p><b>STEEL ROOF TRUSSES, RESILIENT OR RIGID CHANNELS, THERMAL INSULATION, GYPSUM WALLBOARD</b></p> <p><b>Base</b> layer 5/8" proprietary type X gypsum wallboard or gypsum veneer base applied at right angles to resilient or rigid furring channels with 1 1/8" Type S drywall screws 12" o.c. Gypsum board end joints attached with screws 12" o.c. to additional pieces of channel 60" long located 3" back on either side of end joint. <b>Face</b> layer 5/8" proprietary type X gypsum wallboard or gypsum veneer base applied at right angles to channels with 1 5/8" Type S drywall screws 12" o.c. Channels spaced 12" o.c. when insulation is used or 16" o.c. when no insulation is used. Resilient channels applied at right angles to bottom chord of pitched or parallel chord steel trusses 48" o.c. with 1/2" Type S-12 screws or rigid furring channels secured to the bottom chord of each truss with double-strand wire saddle ties (<b>refer to furring channel manufacturer for maximum spans</b>). Optional glass fiber or mineral fiber batt or loose fill insulation applied directly over gypsum board. Trusses supporting metal roof deck panels covered by 1/2" regular gypsum sheathing either loose laid or adhesively or mechanically attached to roof deck. Any thickness polyisocyanurate foamed plastic; polystyrene foamed plastic; or mineral fiber or glass fiber insulation boards laid over gypsum sheathing and covered by a Class A, B, or C roof covering.</p>		
<p><b>PROPRIETARY GYPSUM BOARD</b> National Gypsum Company - 5/8" Gold Bond® Brand FIRE-SHIELD C™ Gypsum Board</p>		<p>Approx. Ceiling Weight: 3 psf Fire Test: UL R3501, 01NK49664, 4-2-03, UL Design P543</p>
<p><b>This Space Left Blank</b></p>		

\*Contact the manufacturer for more detailed information on proprietary products.

**COLUMNS, NONCOMBUSTIBLE****GA FILE NO. CM 1000****GENERIC****1 HOUR  
FIRE****GYPSUM WALLBOARD, STEEL COLUMN COVER**

**Base** layer 1/2" type X gypsum wallboard applied around W10x49 column and held in place with paper masking tape. **Face** layer either No. 24 MSG galvanized steel column cover consisting of two L-shaped sections with snap-lock sheet steel joints or No. 22 MSG galvanized steel column covers consisting of two L-shaped sections with lap joints fastened with No. 8x1/2" sheet metal screws 12" o.c.

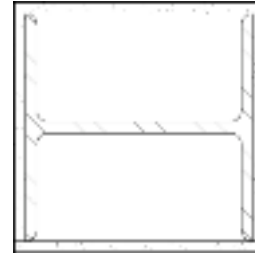

Fire Test: UL NC505-(1-6), 71NK2639,  
12-23-75;  
UL NC505, 77NK1518;  
UL Design X526

**GA FILE NO. CM 1001****GENERIC****1 HOUR  
FIRE****GYPSUM WALLBOARD, STEEL STUDS**

One layer 1/2" type X gypsum wallboard applied without horizontal joints to 1 5/8" steel studs located at each corner of W10x49 column with 1" Type S drywall screws 24" o.c. Metal cornerbead applied to all corners with 1" Type S drywall screws 12" o.c. in each flange. Joint compound 1/16" thick applied over corner bead.

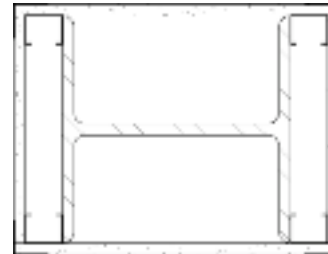



Fire Test: UL NC505, 77NK1747;  
6-13-77,  
UL Design X528

**GA FILE NO. CM 1300****GENERIC****1 HOUR  
FIRE****METAL LATH, GYPSUM PLASTER**

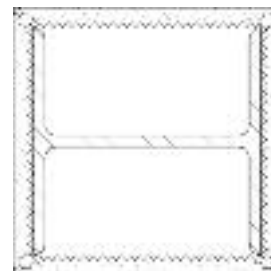
5/8" 1:3 gypsum-sand plaster applied over 3.4 lb metal lath applied around and wire tied to W10x49 column with 18 gage wire 6" o.c.

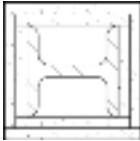

Fire Test: BMS 92/40, 10-7-42

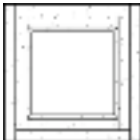
<b>COLUMNS, NONCOMBUSTIBLE</b>		
<b>GA FILE NO. CM 1400</b>	<b>GENERIC</b>	<b>1 HOUR FIRE</b>
<b>GYPSUM WALLBOARD, STEEL COLUMN COVER</b>		
<p><b>Base</b> layer 1/2" type X gypsum wallboard applied around W4x13 column and held in place with paper masking tape. <b>Second</b> layer 1/2" type X gypsum wallboard applied around column and held in place with paper masking tape. <b>Face</b> layer either No. 24 MSG galvanized steel column cover consisting of two L-shaped sections with snap-lock sheet steel joints or No. 22 MSG galvanized steel column covers consisting of two L-shaped sections with lap joints fastened with No. 8x1/2" sheet metal screws 12" o.c.</p>		
		<p>Fire Test: UL NC505-(1-6), 71NK2639, 12-23-75; UL NC505, 77NK1518; UL Design X526</p>
<b>GA FILE NO. CM 1401</b>	<b>GENERIC</b>	<b>1 HOUR FIRE</b>
<b>GYPSUM WALLBOARD, STEEL COLUMN COVER</b>		
<p><b>Base</b> layer 1/2" type X gypsum wallboard applied around W4x13 column and held in place with paper masking tape. <b>Second</b> layer either No. 24 MSG galvanized steel column cover consisting of two L-shaped sections with snap-lock sheet steel joints or No. 22 MSG galvanized steel column covers consisting of two L-shaped sections with lap joints fastened with No. 8x1/2" sheet metal screws 12" o.c. <b>Face</b> layer 1/2" type X gypsum wallboard applied without horizontal joints to column cover with 1" Type S drywall screws 8" o.c. spaced 1" from vertical edges. Metal cornerbead applied to all corners with 1" Type S drywall screws 12" o.c. in each flange.</p>		
		<p>Fire Test: UL NC505-(1-6), 71NK2639, 12-23-75; UL NC505, 77NK1518; UL Design X526</p>
<b>GA FILE NO. CM 1402</b>	<b>GENERIC</b>	<b>1 HOUR FIRE</b>
<b>GYPSUM WALLBOARD, STEEL STUDS</b>		
<p><b>Base</b> layer 1/2" type X gypsum wallboard applied without horizontal joints to 15/8" steel studs located at each corner of W4x13 column with 1" Type S drywall screws 24" o.c. <b>Face</b> layer 1/2" type X gypsum wallboard applied without horizontal joints to studs with 13/4" Type S drywall screws 12" o.c. Metal cornerbead applied to all corners with 1" drywall screws 12" o.c. in each flange. Joint compound 1/16" thick applied over corner bead.</p>		
		<p>Fire Test: UL NC505, 77NK1747, 6-13-77; UL Design X528</p>
<b>GA FILE NO. CM 1450</b>	<b>GENERIC</b>	<b>1 HOUR FIRE</b>
<b>GYPSUM WALLBOARD, STEEL COLUMN COVER</b>		
<p><b>Base</b> layer 1/2" type X gypsum wallboard applied around TS4x4x0.188 tube steel column and held in place with paper masking tape. <b>Second</b> layer 1/2" type X gypsum wallboard applied around column and held in place with paper masking tape. <b>Face</b> layer either No. 24 MSG galvanized steel column cover consisting of two L-shaped sections with snap-lock sheet steel joints or No. 22 MSG galvanized steel column covers consisting of two L-shaped sections with lap joints fastened with No. 8x1/2" sheet metal screws 12" o.c.</p>		
		<p>Fire Test: UL NC505-(1-6), 71NK2639, 12-23-75; UL NC505, 77NK1518; UL Design X526</p>

**COLUMNS, NONCOMBUSTIBLE**

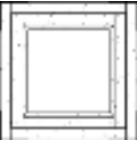
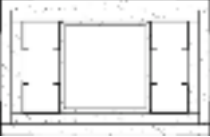
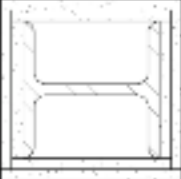
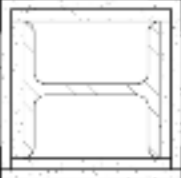
<b>GA FILE NO. CM 1451</b>	<b>GENERIC</b>	<b>1 HOUR FIRE</b>
<p style="text-align: center;"><b>GYPSUM WALLBOARD, STEEL COLUMN COVER</b></p> <p><b>Base</b> layer 1/2" type X gypsum wallboard applied around TS4x4x0.188 tube steel column and held in place with paper masking tape. <b>Second</b> layer either No. 24 MSG galvanized steel column cover consisting of two L-shaped sections with snap-lock sheet steel joints or No. 22 MSG galvanized steel column covers consisting of two L-shaped sections with lap joints fastened with No. 8x1/2" sheet metal screws 12" o.c. <b>Face</b> layer 1/2" type X gypsum wallboard applied without horizontal joints to column cover with 1" Type S drywall screws 8" o.c. spaced 1" from vertical edges. Metal cornerbead applied to all corners with 1" Type S drywall screws 12" o.c. in each flange.</p> <div style="display: flex; justify-content: space-between; align-items: flex-start;"> <div style="width: 60%;">  </div> <div style="width: 35%;"> <p>Fire Test:      UL NC505-(1-6), 71NK2639, 12-23-75; UL NC505, 77NK1518; UL Design X526</p> </div> </div>		
<b>GA FILE NO. CM 1452</b>	<b>GENERIC</b>	<b>1 HOUR FIRE</b>
<p style="text-align: center;"><b>GYPSUM WALLBOARD, STEEL STUDS</b></p> <p><b>Base</b> layer 1/2" type X gypsum wallboard applied without horizontal joints to 15/8" steel studs located at each corner of TS4x4x0.188 tube steel column with 1" Type S drywall screws 24" o.c. <b>Face</b> layer 1/2" type X gypsum wallboard applied without horizontal joints to studs with 13/4" Type S drywall screws 12" o.c. Metal cornerbead applied to all corners with 1" drywall screws 12" o.c. in each flange. Joint compound 1/16" thick applied over corner bead.</p> <div style="display: flex; justify-content: space-between; align-items: flex-start;"> <div style="width: 60%;">  </div> <div style="width: 35%;"> <p>Fire Test:      UL NC505, 77NK1747; 6-13-77, UL Design X528</p> </div> </div>		
<b>GA FILE NO. CM 1600</b>	<b>GENERIC</b>	<b>1 HOUR FIRE</b>
<p style="text-align: center;"><b>GYPSUM WALLBOARD, STEEL COLUMN COVER</b></p> <p><b>Base</b> layer 1/2" type X gypsum wallboard applied around W6x15.5 column and held in place with paper masking tape. <b>Second</b> layer 1/2" type X gypsum wallboard applied around column and held in place with paper masking tape. <b>Face</b> layer either No. 24 MSG galvanized steel column cover consisting of two L-shaped sections with snap-lock sheet steel joints or No. 22 MSG galvanized steel column covers consisting of two L-shaped sections with lap joints fastened with No. 8x1/2" sheet metal screws 12" o.c.</p> <div style="display: flex; justify-content: space-between; align-items: flex-start;"> <div style="width: 60%;">  </div> <div style="width: 35%;"> <p>Fire Test:      UL NC505-(1-6), 71NK2639, 12-23-75; UL NC505, 77NK1518; UL Design X526</p> </div> </div>		
<b>GA FILE NO. CM 1601</b>	<b>GENERIC</b>	<b>1 HOUR FIRE</b>
<p style="text-align: center;"><b>GYPSUM WALLBOARD, STEEL COLUMN COVER</b></p> <p><b>Base</b> layer 1/2" type X gypsum wallboard applied around W6x15.5 column and held in place with paper masking tape. <b>Second</b> layer either No. 24 MSG galvanized steel column cover consisting of two L-shaped sections with snap-lock sheet steel joints or No. 22 MSG galvanized steel column covers consisting of two L-shaped sections with lap joints fastened with No. 8x1/2" sheet metal screws 12" o.c. <b>Face</b> layer 1/2" type X gypsum wallboard applied without horizontal joints to column cover with 1" Type S drywall screws 8" o.c. spaced 1" from vertical edges. Metal cornerbead applied to all corners with 1" Type S drywall screws 12" o.c. in each flange.</p> <div style="display: flex; justify-content: space-between; align-items: flex-start;"> <div style="width: 60%;">  </div> <div style="width: 35%;"> <p>Fire Test:      UL NC505-(1-6), 71NK2639, 12-23-75; UL NC505, 77NK1518; UL Design X526</p> </div> </div>		

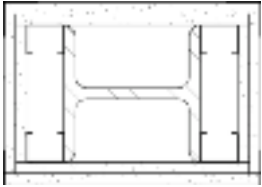
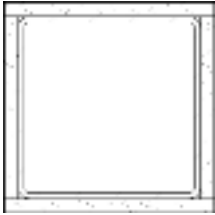
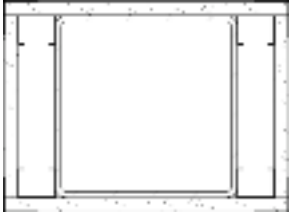
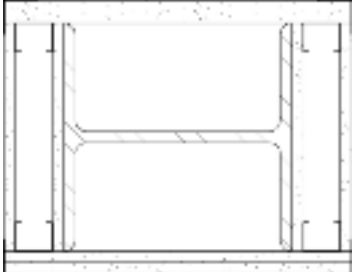
<b>COLUMNS, NONCOMBUSTIBLE</b>		
<b>GA FILE NO. CM 1602</b>	<b>GENERIC</b>	<b>1 HOUR FIRE</b>
<b>GYPSUM WALLBOARD, STEEL STUDS</b>		
<p><b>Base</b> layer 1/2" type X gypsum wallboard applied without horizontal joints to 15/8" steel studs located at each corner of W6x15.5 column with 1" Type S drywall screws 24" o.c. <b>Face</b> layer 1/2" type X gypsum wallboard applied without horizontal joints to studs with 13/4" Type S drywall screws 12" o.c. Metal cornerbead applied to all corners with 1" drywall screws 12" o.c. in each flange. Joint compound 1/16" thick applied over corner bead.</p>		
		<p>Fire Test: UL NC505, 77NK1747, 6-13-77; UL Design X528</p>
<b>GA FILE NO. CM 1850</b>	<b>GENERIC</b>	<b>1 HOUR FIRE</b>
<b>GYPSUM WALLBOARD, STEEL COLUMN COVER</b>		
<p><b>Base</b> layer 5/8" type X gypsum wallboard applied around TS8x8x0.250 tube steel column and held in place with paper masking tape. <b>Face</b> layer either No. 24 MSG galvanized steel column cover consisting of two L-shaped sections with snap-lock sheet steel joints or No. 22 MSG galvanized steel column covers consisting of two L-shaped sections with lap joints fastened with No. 8x1/2" sheet metal screws 12" o.c.</p>		
		<p>Fire Test: UL NC505-(1-6), 71NK2639, 12-23-75; UL NC505, 77NK1518; UL Design X526</p>
<b>GA FILE NO. CM 1851</b>	<b>GENERIC</b>	<b>1 HOUR FIRE</b>
<b>GYPSUM WALLBOARD, STEEL STUDS</b>		
<p>One layer 5/8" type X gypsum wallboard applied without horizontal joints and parallel to 15/8" steel studs located at each corner of TS8x8x0.250 tube steel column with 1" Type S drywall screws 24" o.c. Steel cornerbead, 1 1/2" flanges, applied with 1" Type S drywall screws 12" o.c. in each flange. Joint compound 1/16" thick applied over corner bead.</p>		
		<p>Fire Test: UL NC505, 77NK1747, 6-13-77; UL Design X528</p>
<b>GA FILE NO. CM 2010</b>	<b>GENERIC</b>	<b>2 HOUR FIRE</b>
<b>GYPSUM WALLBOARD</b>		
<p><b>Base</b> layer 1/2" type X gypsum wallboard or gypsum veneer base applied to flanges and across web openings of W10x49 column and fastened to 15/8" steel studs with 1" Type S drywall screws 24" o.c. <b>Face</b> layers 1/2" type X gypsum wallboard or gypsum veneer base applied to studs over flanges with 1" Type S drywall screws 12" o.c. to provide a cavity between boards on the flange. <b>Face</b> layers across the web opening laid flat across the base layer and attached to studs with 15/8" Type S drywall screws 12" o.c. Metal corner bead applied with 4d nails, 13/8" long, 0.067" shank, 13/64" heads, 12" o.c. in each flange.</p>		
		<p>Fire Test: UL R1319-80, 5-27-65, UL Design X518; ULC Design X518</p>



**COLUMNS, NONCOMBUSTIBLE****GA FILE NO. CM 2015****GENERIC****2 HOUR  
FIRE****GYPSUM WALLBOARD, STEEL COLUMN COVER**

**Base** layer 1/2" type X gypsum wallboard applied around W10x49 column and held in place with paper masking tape. **Second** layer 5/8" type X gypsum wallboard applied around column and held in place with paper masking tape. **Face** layer either No. 24 MSG galvanized steel column cover consisting of two L-shaped sections with snap-lock sheet steel joints or No. 22 MSG galvanized steel column covers consisting of two L-shaped sections with lap joints fastened with No. 8x1/2" sheet metal screws 12" o.c.

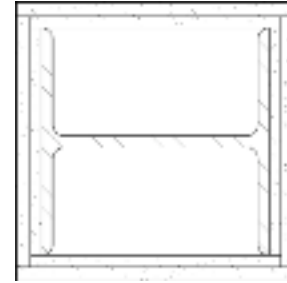

Fire Test: UL NC505-(1-6), 71NK2639,  
12-23-75;  
UL NC505, 77NK1518;  
UL Design X526

**GA FILE NO. CM 2016****GENERIC****2 HOUR  
FIRE****GYPSUM WALLBOARD, STEEL COLUMN COVER**

**Base** layer 1/2" type X gypsum wallboard applied around W10x49 column and held in place with paper masking tape. **Second** layer either No. 24 MSG galvanized steel column cover consisting of two L-shaped sections with snap-lock sheet steel joints or No. 22 MSG galvanized steel column covers consisting of two L-shaped sections with lap joints fastened with No. 8x1/2" sheet metal screws 12" o.c. **Face** layer 5/8" type X gypsum wallboard applied without horizontal joints to column cover with 1" Type S drywall screws 8" o.c. spaced 1" from vertical edges. Metal cornerbead attached to all corners with 1" type S drywall screws 12" o.c. in each flange.

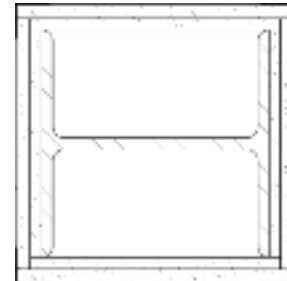

Fire Test: UL NC505-(1-6), 71NK2639,  
12-23-75;  
UL NC505, 77NK1518;  
UL Design X526

**GA FILE NO. CM 2017****GENERIC****2 HOUR  
FIRE****GYPSUM WALLBOARD, STEEL STUDS**

**Base** layer 5/8" type X gypsum wallboard applied without horizontal joints to 1 5/8" steel studs located at each corner of W10x49 column with 1" Type S drywall screws 24" o.c. **Face** layer 1/2" type X gypsum wallboard applied without horizontal joints to studs with 1 3/4" Type S drywall screws 12" o.c. Metal cornerbead applied to all corners with 1" drywall screws 12" o.c. in each flange. Joint compound 1/16" thick applied over corner bead.

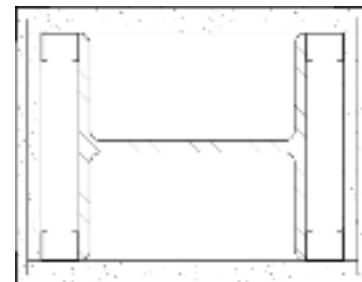

Fire Test: UL NC505, 77NK1747;  
6-13-77,  
UL Design X528

**COLUMNS, NONCOMBUSTIBLE**

**GA FILE NO. CM 2020**

**GENERIC**

**2 HOUR  
FIRE**

**GYPSUM WALLBOARD**

**Base** layer 5/8" type X gypsum wallboard or gypsum veneer base applied around W10x49 column and nailed with 1 3/8" long ring shank nails as required for support. **Second** layer 5/8" type X gypsum wallboard or gypsum veneer base applied around column and nailed with 1 3/8" long ring shank nails as required for support. 1 1/4" x 1 1/4" 25 gage steel angles applied over corners with 1/2" x 0.015" steel straps 30" o.c. wrapped around second layer beginning 18" from each end of column. **Face** layer 5/8" type X gypsum wallboard or gypsum veneer base attached to steel angles. Metal corner bead applied to all corners with 1" Type S drywall screws spaced 12" o.c.

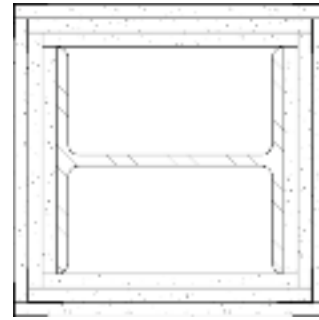

Fire Test: UL R1319-33, 11-3-60,  
UL Design X516

**GA FILE NO. CM 2110**

**GENERIC**

**2 HOUR  
FIRE**

**STEEL STUDS, GYPSUM WALLBOARD**

One layer 1/2" type X gypsum wallboard or gypsum veneer base attached to 1 5/8" steel studs located at each corner of heavy steel W14x228 columns with 1" Type S drywall screws 12" o.c. 1 1/4" metal corner bead applied by crimping 6" o.c.

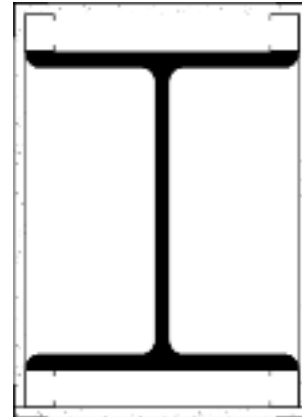

Fire Test: UL R3501-58, 10-10-67,  
UL Design X520;  
ULC Design X520

**GA FILE NO. CM 2120**

**GENERIC**

**2 HOUR  
FIRE**

**STEEL STUDS, GYPSUM WALLBOARD**

**Base** layer 5/8" type X gypsum wallboard or gypsum veneer base applied to 1 5/8" steel studs located at each corner of W10x49 column with 1" Type S screws 24" o.c. **Face** layer 5/8" type X gypsum wallboard or gypsum veneer base applied to studs with 1 5/8" Type S drywall screws 12" o.c. 1 1/4" metal corner bead applied with 6d coated nails, 1 3/4" long, 0.0915" shank, 1/4" heads, 12" o.c. in each flange.

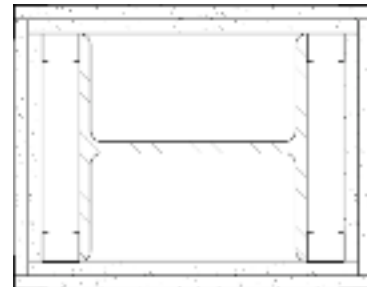

Fire Test: UL R2717-34, 5-15-64,  
UL Design X517;  
ULC Design Z503

**COLUMNS, NONCOMBUSTIBLE**

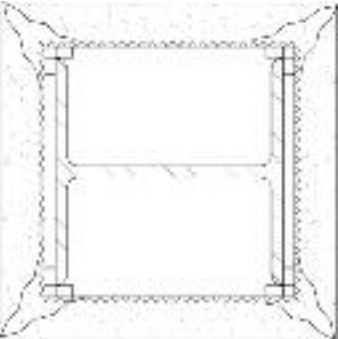
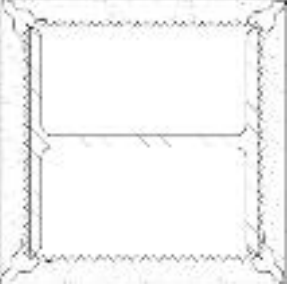
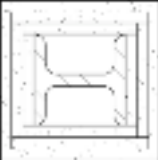
<b>GA FILE NO. CM 2310</b>	<b>GENERIC</b>	<b>2 HOUR FIRE</b>
<p style="text-align: center;"><b>METAL LATH, GYPSUM PLASTER</b></p> <p>1<sup>5</sup>/<sub>8</sub>" 1:1-1:1 wood-fibered gypsum-sand plaster applied over 3.4 lb diamond mesh expanded metal lath wire tied with 18 gage wire 6" o.c. at seams applied over 1/2" x 3/4" spacers 40" o.c. Spacers made of 3/4" furring channel with 2" legs bent around each corner of W10x49 column.</p> <div style="text-align: right; margin-right: 100px;">  </div> <p style="text-align: right; margin-right: 100px;">Fire Test:      UL R4024-10, 1-5-67</p>		
<b>GA FILE NO. CM 2320</b>	<b>GENERIC</b>	<b>2 HOUR FIRE</b>
<p style="text-align: center;"><b>METAL LATH, GYPSUM PLASTER</b></p> <p>1" 1:2-1:3 gypsum-perlite plaster applied over 3.4 lb. self-furring expanded diamond mesh metal lath and 2 1/2" wide flanged expanded metal corner beads wire tied to W10x49 column with 18 gage galvanized wire 6" o.c.</p> <div style="text-align: right; margin-right: 100px;">  </div> <p style="text-align: right; margin-right: 100px;">Fire Test:      UL R3187-4, -5, -7, 7-30-52, UL Design X402</p>		
<b>GA FILE NO. CM 2400</b>	<b>GENERIC</b>	<b>2 HOUR FIRE</b>
<p style="text-align: center;"><b>GYPSUM WALLBOARD, STEEL COLUMN COVER</b></p> <p><b>Base</b> layer 1/2" type X gypsum wallboard applied around W4x13 column and held in place with paper masking tape. <b>Second</b> layer 1/2" type X gypsum wallboard applied around column and held in place with paper masking tape. <b>Third</b> layer 1/2" type X gypsum wallboard applied around column and held in place with paper masking tape. <b>Face</b> layer either No. 24 MSG galvanized steel column cover consisting of two L-shaped sections with snap-lock sheet steel joints or No. 22 MSG galvanized steel column covers consisting of two L-shaped sections with lap joints fastened with No. 8x1/2" sheet metal screws 12" o.c.</p> <div style="text-align: right; margin-right: 100px;">  </div> <p style="text-align: right; margin-right: 100px;">Fire Test:      UL NC505-(1-6), 71NK2639, 12-23-75; UL NC505, 77NK1518; UL Design X526</p>		

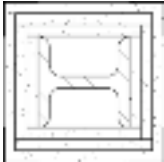
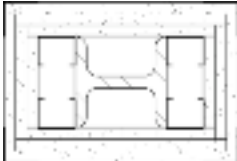
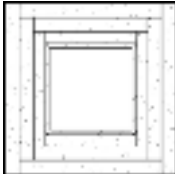
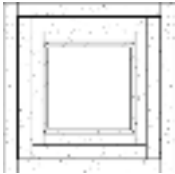
<b>COLUMNS, NONCOMBUSTIBLE</b>		
<b>GA FILE NO. CM 2401</b>	<b>GENERIC</b>	<b>2 HOUR FIRE</b>
<b>GYPSON WALLBOARD, STEEL COLUMN COVER</b>		
<p><b>Base</b> layer 1/2" type X gypsum wallboard applied around W4x13 column and held in place with paper masking tape. <b>Second</b> layer 1/2" type X gypsum wallboard applied around column and held in place with paper masking tape. <b>Third</b> layer either No. 24 MSG galvanized steel column cover consisting of two L-shaped sections with snap-lock sheet steel joints or No. 22 MSG galvanized steel column covers consisting of two L-shaped sections with lap joints fastened with No. 8x1/2" sheet metal screws 12" o.c. <b>Face</b> layer 1/2" type X gypsum wallboard applied without horizontal joints to column cover with 1" Type S drywall screws 8" o.c. spaced 1" from vertical edges. Metal cornerbead attached to all corners with 1" type S drywall screws 12" o.c. in each flange.</p>		
		<p>Fire Test: UL NC505-(1-6), 71NK2639, 12-23-75; UL NC505, 77NK1518; UL Design X526</p>
<b>GA FILE NO. CM 2402</b>	<b>GENERIC</b>	<b>2 HOUR FIRE</b>
<b>GYPSON WALLBOARD, STEEL STUDS</b>		
<p><b>Base</b> layer 1/2" type X gypsum wallboard applied without horizontal joints to 15/8" steel studs located at each corner of W4x13 column with 1" Type S drywall screws 24" o.c. <b>Second</b> layer 1/2" type X gypsum board applied without horizontal joints with 13/4" Type S drywall screws 12" o.c. and wire tied with 18 ga. wire 24" o.c. <b>Face</b> layer 1/2" type X gypsum wallboard applied without horizontal joints to studs with 21/4" Type S drywall screws 12" o.c. Metal cornerbead applied to all corners with 1" drywall screws 12" o.c. in each flange. Joint compound 1/16" thick applied over corner bead.</p>		
		<p>Fire Test: UL NC505, 77NK1747, 6-13-77, UL Design X528</p>
<b>GA FILE NO. CM 2453</b>	<b>GENERIC</b>	<b>2 HOUR FIRE</b>
<b>GYPSON WALLBOARD, STEEL COLUMN COVER</b>		
<p><b>Base</b> layer 1/2" type X gypsum wallboard applied around TS4x4x0.188 tube steel column and held in place with paper masking tape. <b>Second</b> layer 5/8" type X gypsum wallboard applied around column and held in place with paper masking tape. <b>Third</b> layer 5/8" type X gypsum wallboard applied around column and held in place with paper masking tape. <b>Face</b> layer either No. 24 MSG galvanized steel column cover consisting of two L-shaped sections with snap-lock sheet steel joints or No. 22 MSG galvanized steel column covers consisting of two L-shaped sections with lap joints fastened with No. 8x1/2" sheet metal screws 12" o.c.</p>		
		<p>Fire Test: UL NC505-(1-6), 71NK2639, 12-23-75; UL NC505, 77NK1518; UL NC505, 3-6-06; UL Design X526</p>
<b>GA FILE NO. CM 2454</b>	<b>GENERIC</b>	<b>2 HOUR FIRE</b>
<b>GYPSON WALLBOARD, STEEL COLUMN COVER</b>		
<p><b>Base</b> layer 1/2" type X gypsum wallboard applied around TS4x4x0.188 tube steel column and held in place with paper masking tape. <b>Second</b> layer 5/8" type X gypsum wallboard applied around column and held in place with paper masking tape. <b>Third</b> layer either No. 24 MSG galvanized steel column cover consisting of two L-shaped sections with snap-lock sheet steel joints or No. 22 MSG galvanized steel column covers consisting of two L-shaped sections with lap joints fastened with No. 8x1/2" sheet metal screws 12" o.c. <b>Face</b> layer 5/8" type X gypsum wallboard applied without horizontal joints to column cover with 1" Type S drywall screws 8" o.c. spaced 1" from vertical edges. Metal cornerbead attached to all corners with 1" type S drywall screws 12" o.c. in each flange.</p>		
		<p>Fire Test: UL NC505-(1-6), 71NK2639, 12-23-75; UL NC505, 77NK1518; UL NC505, 3-6-06; UL Design X526</p>

**COLUMNS, NONCOMBUSTIBLE**

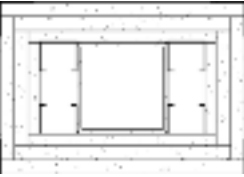
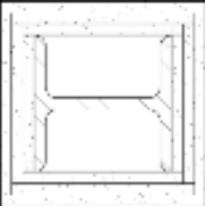
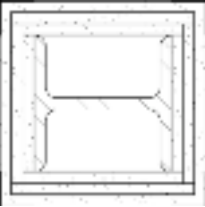
GA FILE NO. CM 2455	GENERIC	2 HOUR FIRE
<p style="text-align: center;"><b>GYPSUM WALLBOARD, STEEL STUDS</b></p> <p><b>Base</b> layer 1/2" type X gypsum wallboard applied without horizontal joints to 15/8" steel studs located at each corner of TS4x4x0.188 tube steel column with 1" Type S drywall screws 24" o.c. <b>Second</b> layer 5/8" type X gypsum board applied without horizontal joints with 13/4" Type S drywall screws 12" o.c. and wire tied with 18 ga. wire 24" o.c. <b>Face</b> layer 5/8" type X gypsum wallboard applied without horizontal joints to studs with 21/4" Type S drywall screws 12" o.c. Metal cornerbead applied to all corners with 1" drywall screws 12" o.c. in each flange. Joint compound 1/16" thick applied over corner bead.</p> <div style="text-align: right; margin-top: 100px;">  </div> <div style="text-align: right; margin-top: 100px;"> <p>Fire Test:      UL NC505, 77NK1747, 6-13-77; UL NC505, 3-6-06; UL Design X528</p> </div>		
GA FILE NO. CM 2600	GENERIC	2 HOUR FIRE
<p style="text-align: center;"><b>GYPSUM WALLBOARD, STEEL COLUMN COVER</b></p> <p><b>Base</b> layer 1/2" type X gypsum wallboard applied around W6x15.5 column and held in place with paper masking tape. <b>Second</b> layer 1/2" type X gypsum wallboard applied around column and held in place with paper masking tape. <b>Third</b> layer 1/2" type X gypsum wallboard applied around column and held in place with paper masking tape. <b>Face</b> layer either No. 24 MSG galvanized steel column cover consisting of two L-shaped sections with snap-lock sheet steel joints or No. 22 MSG galvanized steel column covers consisting of two L-shaped sections with lap joints fastened with No. 8x1/2" sheet metal screws 12" o.c.</p> <div style="text-align: right; margin-top: 100px;">  </div> <div style="text-align: right; margin-top: 100px;"> <p>Fire Test:      UL NC505-(1-6), 71NK2639, 12-23-75; UL NC505, 77NK1518; UL Design X526</p> </div>		
GA FILE NO. CM 2601	GENERIC	2 HOUR FIRE
<p style="text-align: center;"><b>GYPSUM WALLBOARD, STEEL COLUMN COVER</b></p> <p><b>Base</b> layer 1/2" type X gypsum wallboard applied around W6x15.5 column and held in place with paper masking tape. <b>Second</b> layer 1/2" type X gypsum wallboard applied around column and held in place with paper masking tape. <b>Third</b> layer either No. 24 MSG galvanized steel column cover consisting of two L-shaped sections with snap-lock sheet steel joints or No. 22 MSG galvanized steel column covers consisting of two L-shaped sections with lap joints fastened with No. 8x1/2" sheet metal screws 12" o.c. <b>Face</b> layer 1/2" type X gypsum wallboard applied without horizontal joints to column cover with 1" Type S drywall screws 8" o.c. spaced 1" from vertical edges. Metal cornerbead attached to all corners with 1" type S drywall screws 12" o.c. in each flange.</p> <div style="text-align: right; margin-top: 100px;">  </div> <div style="text-align: right; margin-top: 100px;"> <p>Fire Test:      UL NC505-(1-6), 71NK2639, 12-23-75; UL NC505, 77NK1518; UL Design X526</p> </div>		

**COLUMNS, NONCOMBUSTIBLE**

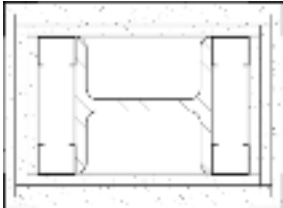
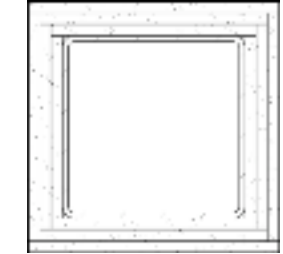
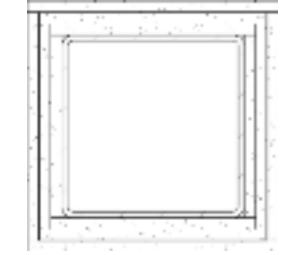
<p><b>GA FILE NO. CM 2602</b></p> <p><b>GYPSUM WALLBOARD, STEEL STUDS</b></p> <p><b>Base</b> layer 1/2" type X gypsum wallboard applied without horizontal joints to 15/8" steel studs located at each corner of W6x15.5 column with 1" Type S drywall screws 24" o.c. <b>Second</b> layer 1/2" type X gypsum board applied without horizontal joints with 13/4" Type S drywall screws 12" o.c. and wire tied with 18 ga. wire 24" o.c. <b>Face</b> layer 1/2" type X gypsum wallboard applied without horizontal joints to studs with 21/4" Type S drywall screws 12" o.c. Metal cornerbead applied to all corners with 1" drywall screws 12" o.c. in each flange. Joint compound 1/16" thick applied over corner bead.</p>	<p><b>GENERIC</b></p>	<p><b>2 HOUR FIRE</b></p>  <p>Fire Test: UL NC505, 77NK1747, 6-13-77, UL Design X528</p>
<p><b>GA FILE NO. CM 2801</b></p> <p><b>GYPSUM WALLBOARD, STEEL COLUMN COVER</b></p> <p><b>Base</b> layer 1/2" type X gypsum wallboard applied around TS8x8x0.0250 tube steel column and held in place with paper masking tape. <b>Second</b> layer 1/2" type X gypsum wallboard applied around column and held in place with paper masking tape. <b>Third</b> layer 1/2" type X gypsum wallboard applied around column and held in place with paper masking tape. <b>Face</b> layer either No. 24 MSG galvanized steel column cover consisting of two L-shaped sections with snap-lock sheet steel joints or No. 22 MSG galvanized steel column covers consisting of two L-shaped sections with lap joints fastened with No. 8x1/2" sheet metal screws 12" o.c.</p>	<p><b>GENERIC</b></p>	<p><b>2 HOUR FIRE</b></p>  <p>Fire Test: UL NC505-(1-6), 71NK2639, 12-23-75; UL NC505, 77NK1518; UL NC505, 3-6-06; UL Design X526</p>
<p><b>GA FILE NO. CM 2802</b></p> <p><b>GYPSUM WALLBOARD, STEEL COLUMN COVER</b></p> <p><b>Base</b> layer 1/2" type X gypsum wallboard applied around TS8x8x0.250 tube steel column and held in place with paper masking tape. <b>Second</b> layer 1/2" type X gypsum wallboard applied around column and held in place with paper masking tape. <b>Third</b> layer either No. 24 MSG galvanized steel column cover consisting of two L-shaped sections with snap-lock sheet steel joints or No. 22 MSG galvanized steel column covers consisting of two L-shaped sections with lap joints fastened with No. 8x1/2" sheet metal screws 12" o.c. <b>Face</b> layer 1/2" type X gypsum wallboard applied without horizontal joints to column cover with 1" Type S drywall screws 8" o.c. spaced 1" from vertical edges. Metal cornerbead attached to all corners with 1" type S drywall screws 12" o.c. in each flange.</p>	<p><b>GENERIC</b></p>	<p><b>2 HOUR FIRE</b></p>  <p>Fire Test: UL NC505-(1-6), 71NK2639, 12-23-75; UL NC505, 77NK1518; UL NC505, 3-6-06; UL Design X526</p>

**COLUMNS, NONCOMBUSTIBLE**

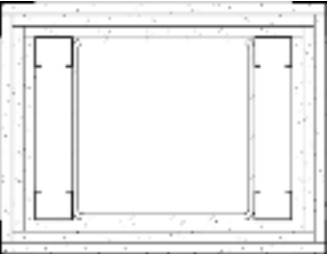
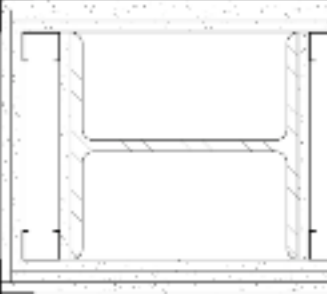
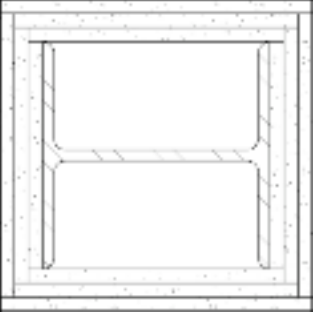
<b>GA FILE NO. CM 2803</b>	<b>GENERIC</b>	<b>2 HOUR FIRE</b>																								
<p align="center"><b>GYPSUM WALLBOARD, STEEL STUDS</b></p> <p><b>Base</b> layer 1/2" type X gypsum wallboard applied without horizontal joints to 1 5/8" steel studs located at each corner of TS8x8x0.250 tube steel column with 1" Type S drywall screws 24" o.c. <b>Second</b> layer 1/2" type X gypsum board applied without horizontal joints with 1 3/4" Type S drywall screws 12" o.c. and wire tied with 18 ga. wire 24" o.c. <b>Face</b> layer 1/2" type X gypsum wallboard applied without horizontal joints to studs with 2 1/4" Type S drywall screws 12" o.c. Metal cornerbead applied to all corners with 1" drywall screws 12" o.c. in each flange. Joint compound 1/16" thick applied over corner bead.</p>																										
<p align="center"><b>STEEL STUDS, GYPSUM WALLBOARD</b></p> <p><b>Base</b> layer 1/2" proprietary type X gypsum wallboard applied to flanges and across web openings of W10x49 column and fastened to 1 5/8" steel studs with 1" type S drywall screws 24" o.c. <b>Second</b> layer 1/2" proprietary gypsum wallboard applied to studs with 1 5/8" type S drywall screws 12" o.c. creating a stud cavity between base and second layers over column flanges. <b>Face</b> layer 1/2" proprietary gypsum wallboard applied to studs with 2 1/4" type S drywall screws 12" o.c. 1 1/4" corner bead applied with 4d drywall nails. Joint compound 1/16" thick applied over corner bead and face layer.</p> <p align="center"><b>PROPRIETARY GYPSUM BOARD</b></p> <table border="0"> <tr> <td>American Gypsum Company LLC</td> <td>-</td> <td>1/2" FireBloc® Type C</td> </tr> <tr> <td>CertainTeed Gypsum Inc.</td> <td>-</td> <td>1/2" ProRoc® Type C Gypsum Panels</td> </tr> <tr> <td>Georgia-Pacific Gypsum LLC</td> <td>-</td> <td>1/2" ToughRock® Fireguard C™</td> </tr> <tr> <td>Lafarge North America Inc.</td> <td>-</td> <td>1/2" Firecheck® Type C</td> </tr> <tr> <td>National Gypsum Company</td> <td>-</td> <td>1/2" Gold Bond® Brand FIRE-SHIELD C™ Gypsum Board</td> </tr> <tr> <td>PABCO Gypsum</td> <td>-</td> <td>1/2" FLAME CURB® Super 'C'™</td> </tr> <tr> <td>Temple-Inland</td> <td>-</td> <td>1/2" TG-C</td> </tr> <tr> <td>United States Gypsum Company</td> <td>-</td> <td>1/2" SHEETROCK® Brand FIRECODE® C Core Gypsum Panels</td> </tr> </table>		American Gypsum Company LLC	-	1/2" FireBloc® Type C	CertainTeed Gypsum Inc.	-	1/2" ProRoc® Type C Gypsum Panels	Georgia-Pacific Gypsum LLC	-	1/2" ToughRock® Fireguard C™	Lafarge North America Inc.	-	1/2" Firecheck® Type C	National Gypsum Company	-	1/2" Gold Bond® Brand FIRE-SHIELD C™ Gypsum Board	PABCO Gypsum	-	1/2" FLAME CURB® Super 'C'™	Temple-Inland	-	1/2" TG-C	United States Gypsum Company	-	1/2" SHEETROCK® Brand FIRECODE® C Core Gypsum Panels	<p align="center"><b>3 HOUR FIRE</b></p> 
American Gypsum Company LLC	-	1/2" FireBloc® Type C																								
CertainTeed Gypsum Inc.	-	1/2" ProRoc® Type C Gypsum Panels																								
Georgia-Pacific Gypsum LLC	-	1/2" ToughRock® Fireguard C™																								
Lafarge North America Inc.	-	1/2" Firecheck® Type C																								
National Gypsum Company	-	1/2" Gold Bond® Brand FIRE-SHIELD C™ Gypsum Board																								
PABCO Gypsum	-	1/2" FLAME CURB® Super 'C'™																								
Temple-Inland	-	1/2" TG-C																								
United States Gypsum Company	-	1/2" SHEETROCK® Brand FIRECODE® C Core Gypsum Panels																								
<b>GA FILE NO. CM 3115</b>	<b>GENERIC</b>	<b>3 HOUR FIRE</b>																								
<p align="center"><b>GYPSUM WALLBOARD, STEEL COLUMN COVER</b></p> <p><b>Base</b> layer 5/8" type X gypsum wallboard applied around W10x49 column and held in place with paper masking tape. <b>Second</b> layer 5/8" type X gypsum wallboard applied around column and held in place with paper masking tape. <b>Third</b> layer 5/8" type X gypsum wallboard applied around column and held in place with paper masking tape. <b>Face</b> layer either No. 24 MSG galvanized steel column cover consisting of two L-shaped sections with snap-lock sheet steel joints or No. 22 MSG galvanized steel column covers consisting of two L-shaped sections with lap joints fastened with No. 8x1/2" sheet metal screws 12" o.c.</p>																										
<p>Fire Test: UL NC505, 77NK1747, 6-13-77; UL NC505, 3-6-06; UL Design X528</p>		<p>Fire Test: UL R7094, 90NK10635, 12-4-90, UL Design X515</p>																								
<p>Fire Test: UL NC505-(1-6), 71NK2639, 12-23-75; UL NC505, 77NK1518; UL Design X526</p>																										

*\*Contact the manufacturer for more detailed information on proprietary products.*

**COLUMNS, NONCOMBUSTIBLE**

**GA FILE NO. CM 3116**

**GENERIC**

**3 HOUR  
FIRE**

**GYPSUM WALLBOARD, STEEL STUDS**

**Base** layer 5/8" type X gypsum wallboard applied without horizontal joints to 15/8" steel studs located at each corner of W10x49 column with 1" Type S drywall screws 24" o.c. **Second** layer 5/8" type X gypsum board applied without horizontal joints with 13/4" Type S drywall screws 12" o.c. and wire tied with 18 ga. wire 24" o.c. **Face** layer 5/8" type X gypsum wallboard applied without horizontal joints to studs with 21/4" Type S drywall screws 12" o.c. Metal cornerbead applied to all corners with 1" drywall screws 12" o.c. in each flange. Joint compound 1/16" thick applied over corner bead.

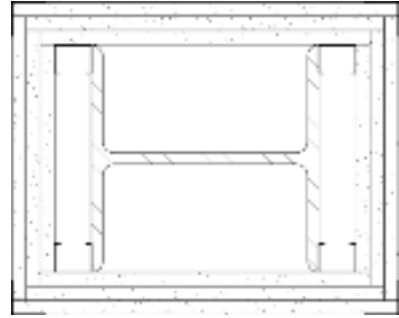

Fire Test: UL NC505, 77NK1747; 6-13-77, UL Design X528

**GA FILE NO. CM 3120**

**GENERIC**

**3 HOUR  
FIRE**

**STEEL STUDS, GYPSUM WALLBOARD**

**Base** layer 5/8" type X gypsum wallboard or gypsum veneer base applied to 15/8" steel studs located at each corner of W10x49 column with 1" Type S drywall screws 24" o.c. **Second** layer 5/8" type X gypsum wallboard or gypsum veneer base applied to studs with 15/8" Type S drywall screws 12" o.c. and 18 gage wire tied 24" o.c. **Face** layer 5/8" type X gypsum wallboard or gypsum veneer base applied to studs with 21/4" Type S drywall screws 12" o.c. Metal cornerbead applied with 6d coated nails, 17/8" long, 0.0915" shank, 1/4" heads, 12" o.c. in each flange.

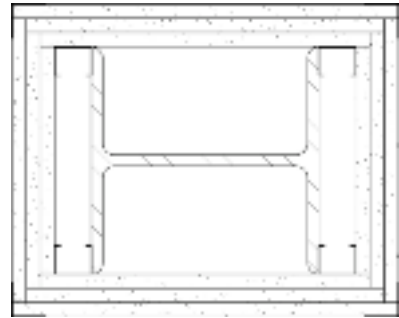

Fire Test: UL R2717-31, 2-20-64, UL Design X509; UL R3501-36, 7-31-64, UL Design X510; ULC Design Z502

**GA FILE NO. CM 3130**

**GENERIC**

**3 HOUR  
FIRE**

**STEEL STUDS, GYPSUM WALLBOARD**

**Base** layer 1/2" type X gypsum wallboard or gypsum veneer base applied to 15/8" steel studs located at corners of heavy steel W14x228 column with 1" Type S drywall screws 24" o.c. **Face** layer 1/2" type X gypsum wallboard or gypsum veneer base applied to studs with 15/8" Type S drywall screws 12" o.c. 1" corner bead applied with 4d coated nails, 13/8" long, 0.067" shank, 13/64" heads, 12" o.c.

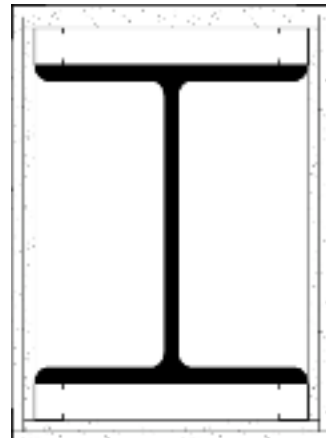

Fire Test: UL R3501-61, 7-16-69, UL Design X513; ULC Design X513

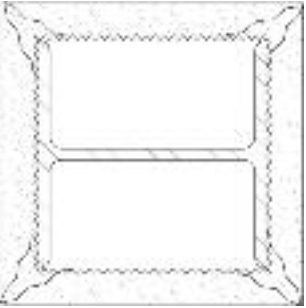
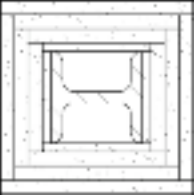
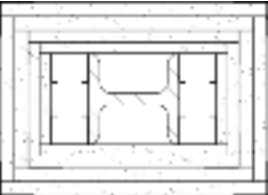

## COLUMNS, NONCOMBUSTIBLE

GA FILE NO. CM 3310	GENERIC	3 HOUR FIRE
<p style="text-align: center;"><b>METAL LATH, GYPSUM PLASTER</b></p> <p>1<sup>3</sup>/<sub>8</sub>" 1:2-1:3 gypsum-perlite plaster applied over 3.4 lb. self-furring expanded diamond mesh metal lath and 2<sup>1</sup>/<sub>2</sub>" wide flanged expanded metal corner beads wire tied to W10x49 column with 18 gage galvanized wire 6" o.c.</p> <div style="text-align: right; margin-right: 100px;">  </div> <p style="text-align: right; margin-right: 100px;">Fire Test:      UL R3187-4, -5, -7; 7-30-52, UL Design X402</p>		
GA FILE NO. CM 3400	GENERIC	3 HOUR FIRE
<p style="text-align: center;"><b>GYPSUM WALLBOARD, STEEL COLUMN COVER</b></p> <p><b>Base</b> layer 3/8" regular gypsum wallboard applied around W4x13 column and held in place with paper masking tape. <b>Second</b> layer 5/8" type X gypsum wallboard applied around column and held in place with paper masking tape. <b>Third</b> layer 5/8" type X gypsum wallboard applied around column and held in place with paper masking tape. <b>Fourth</b> layer 5/8" type X gypsum wallboard applied around column and held in place with paper masking tape. <b>Face</b> layer either No. 24 MSG galvanized steel column cover consisting of two L-shaped sections with snap-lock sheet steel joints or No. 22 MSG galvanized steel column covers consisting of two L-shaped sections with lap joints fastened with No. 8x1/2" sheet metal screws 12" o.c.</p> <div style="text-align: right; margin-right: 100px;">  </div> <p style="text-align: right; margin-right: 100px;">Fire Test:      UL NC505-7, 76NK8228, 2-15-77; UL NC505, 77NK1518; UL Design X526</p>		
GA FILE NO. CM 3401	GENERIC	3 HOUR FIRE
<p style="text-align: center;"><b>GYPSUM WALLBOARD, STEEL STUDS</b></p> <p><b>Base</b> layer 1/2" type X gypsum wallboard applied without horizontal joints to 1<sup>5</sup>/<sub>8</sub>" steel studs located at each corner of W4x13 column with 1" Type S drywall screws 24" o.c. <b>Second</b> layer 1/2" type X gypsum board applied without horizontal joints with 1<sup>3</sup>/<sub>4</sub>" Type S drywall screws 12" o.c. Steel angle, 2"x2"x25 ga., applied to all corners over second layer with 1<sup>3</sup>/<sub>4</sub>" Type S drywall screws 12" o.c. in each flange. <b>Third</b> layer 5/8" type X gypsum wallboard applied without horizontal joints to steel angles with 1" Type S drywall screws 12" o.c. <b>Face</b> layer 5/8" type X gypsum wallboard applied without horizontal joints to steel angles with 1<sup>3</sup>/<sub>4</sub>" Type S drywall screws 12" o.c. Metal cornerbead applied to all corners with 1" drywall screws 12" o.c. in each flange. Joint compound 1/16" thick applied over corner bead.</p> <div style="text-align: right; margin-right: 100px;">  </div> <p style="text-align: right; margin-right: 100px;">Fire Test:      UL NC505, 77NK1747, 6-13-77, UL Design X528</p>		

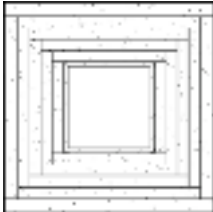
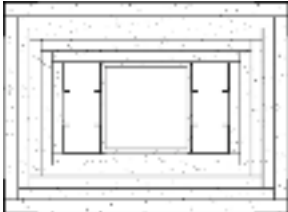
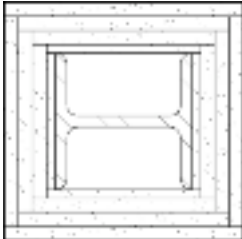
COLUMNS, NONCOMBUSTIBLE		
GA FILE NO. CM 3452	GENERIC	3 HOUR FIRE
<p><b>GYPSUM WALLBOARD, STEEL COLUMN COVER</b></p> <p><b>Base</b> layer 1/2" type X gypsum wallboard applied around TS4x4x0.188 column and held in place with paper masking tape. <b>Second</b> layer 1/2" type X gypsum wallboard applied around column and held in place with paper masking tape. <b>Third</b> layer 1/2" type X gypsum wallboard applied around column and held in place with paper masking tape. <b>Fourth</b> layer 1/2" type X gypsum wallboard applied around column and held in place with paper masking tape. <b>Fifth</b> layer 5/8" type X gypsum wallboard applied around column and held in place with paper masking tape. <b>Face</b> layer either No. 24 MSG galvanized steel column cover consisting of two L-shaped sections with snap-lock sheet steel joints or No. 22 MSG galvanized steel column covers consisting of two L-shaped sections with lap joints fastened with No. 8x1/2" sheet metal screws 12" o.c.</p>		
		<p>Fire Test: UL NC505-(1-6), 71NK2639, 12-23-75; UL NC505, 77NK1518; UL NC505, 3-6-06; UL Design X526</p>
GA FILE NO. CM 3454	GENERIC	3 HOUR FIRE
<p><b>GYPSUM WALLBOARD, STEEL STUDS</b></p> <p><b>Base</b> layer 1/2" type X gypsum wallboard applied without horizontal joints to 1 5/8" steel studs located at each corner of TS 4x4x0.188 tube steel column with 1" Type S drywall screws 24" o.c. <b>Second</b> layer 1/2" type X gypsum board applied without horizontal joints with 1 3/4" Type S drywall screws 12" o.c. Steel angle, 2"x2"x25 ga., applied to all corners over second layer with 1 3/4" Type S drywall screws 12" o.c. in each flange. <b>Third</b> layer 1/2" type X gypsum wallboard applied without horizontal joints to steel angles with 1" Type S drywall screws 12" o.c. <b>Fourth</b> layer 1/2" type X gypsum wallboard applied without horizontal joints to steel angles with 1 3/4" Type S drywall screws 12" o.c. <b>Face</b> layer 5/8" type X gypsum wallboard applied without horizontal joints to steel angles with 2" Type S drywall screws 12" o.c. Metal cornerbead applied to all corners with 1" Type S drywall screws 12" o.c. in each flange. Joint compound 1/16" thick applied over corner bead.</p>		
		<p>Fire Test: UL NC505, 77NK1747, 6-13-77; UL NC505, 3-6-06; UL Design X528</p>
GA FILE NO. CM 3600	GENERIC	3 HOUR FIRE
<p><b>GYPSUM WALLBOARD, STEEL COLUMN COVER</b></p> <p><b>Base</b> layer 3/8" regular gypsum wallboard applied around W6x15.5 column and held in place with paper masking tape. <b>Second</b> layer 5/8" type X gypsum wallboard applied around column and held in place with paper masking tape. <b>Third</b> layer 5/8" type X gypsum wallboard applied around column and held in place with paper masking tape. <b>Fourth</b> layer 5/8" type X gypsum wallboard applied around column and held in place with paper masking tape. <b>Face</b> layer either No. 24 MSG galvanized steel column cover consisting of two L-shaped sections with snap-lock sheet steel joints or No. 22 MSG galvanized steel column covers consisting of two L-shaped sections with lap joints fastened with No. 8x1/2" sheet metal screws 12" o.c.</p>		
		<p>Fire Test: UL NC505-(1-6), 71NK2639, 12-23-75; UL NC505, 77NK1518; UL Design X526</p>

**COLUMNS, NONCOMBUSTIBLE****GA FILE NO. CM 3601****GENERIC****3 HOUR  
FIRE****GYPSUM WALLBOARD, STEEL STUDS**

**Base** layer 1/2" type X gypsum wallboard applied without horizontal joints to 15/8" steel studs located at each corner of W6x15.5 column with 1" Type S drywall screws 24" o.c. **Second** layer 1/2" type X gypsum board applied without horizontal joints with 13/4" Type S drywall screws 12" o.c. Steel angle, 2"x2"x25 ga., applied to all corners over second layer with 13/4" Type S drywall screws 12" o.c. in each flange. **Third** layer 5/8" type X gypsum wallboard applied without horizontal joints to steel angles with 1" Type S drywall screws 12" o.c. **Face** layer 5/8" type X gypsum wallboard applied without horizontal joints to steel angles with 13/4" Type S drywall screws 12" o.c. Metal cornerbead applied to all corners with 1" drywall screws 12" o.c. in each flange. Joint compound 1/16" thick applied over corner bead.

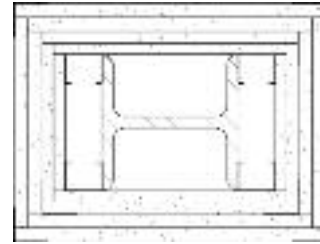

Fire Test: UL NC505, 77NK1747,  
6-13-77,  
UL Design X528

**GA FILE NO. CM 3801****GENERIC****3 HOUR  
FIRE****GYPSUM WALLBOARD, STEEL COLUMN COVER**

**Base** layer 1/2" type X gypsum wallboard applied around TS8x8x0.0250 tube steel column and held in place with paper masking tape. **Second** layer 1/2" type X gypsum wallboard applied around column and held in place with paper masking tape. **Third** layer 5/8" type X gypsum wallboard applied around column and held in place with paper masking tape. **Fourth** layer 5/8" type X gypsum wallboard applied around column and held in place with paper masking tape. **Face** layer either No. 24 MSG galvanized steel column cover consisting of two L-shaped sections with snap-lock sheet steel joints or No. 22 MSG galvanized steel column covers consisting of two L-shaped sections with lap joints fastened with No. 8x1/2" sheet metal screws 12" o.c.

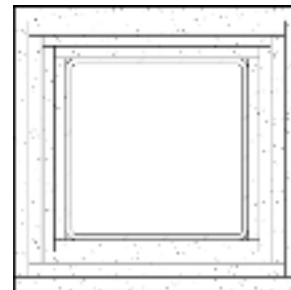

Fire Test: UL NC505-(1-6), 71NK2639,  
12-23-75;  
UL NC505, 77NK1518;  
UL NC505, 3-6-06;  
UL Design X526

**GA FILE NO. CM 3803****GENERIC****3 HOUR  
FIRE****GYPSUM WALLBOARD, STEEL STUDS**

**Base** layer 1/2" type X gypsum wallboard applied without horizontal joints to 15/8" steel studs located at each corner of TS8x8x0.250 tube steel column with 1" Type S drywall screws 24" o.c. **Second** layer 1/2" type X gypsum board applied without horizontal joints with 13/4" Type S drywall screws 12" o.c. and wire tied with 18 ga. wire 24" o.c. **Third** layer 5/8" type X gypsum wallboard applied without horizontal joints to studs with 21/4" Type S drywall screws 12" o.c. **Face** layer 5/8" type X gypsum wallboard applied without horizontal joints to studs with 3" Type S drywall screws 12" o.c. Metal cornerbead applied to all corners with 1" drywall screws 12" o.c. in each flange. Joint compound 1/16" thick applied over corner bead.

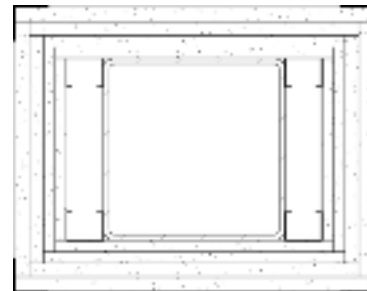

Fire Test: UL NC505, 77NK1747,  
6-13-77; UL NC505, 3-6-06;  
UL Design X528

**COLUMNS, NONCOMBUSTIBLE**

**GA FILE NO. CM 4110**

**GENERIC**

**4 HOUR  
FIRE**

**GYPSUM WALLBOARD, STEEL COLUMN COVER**

**Base** layer 5/8" type X gypsum wallboard applied around W10x49 column and held in place with paper masking tape. **Second** layer 5/8" type X gypsum wallboard applied around column and held in place with paper masking tape. **Third** layer 5/8" type X gypsum wallboard applied around column and held in place with paper masking tape. **Fourth** layer 5/8" type X gypsum wallboard applied around column and held in place with paper masking tape. **Face** layer either No. 24 MSG stainless steel column cover consisting of two L-shaped sections with snap-lock sheet steel joints or No. 22 MSG stainless steel column covers consisting of two L-shaped sections with lap joints fastened with No. 8x1/2" sheet metal screws 12" o.c.

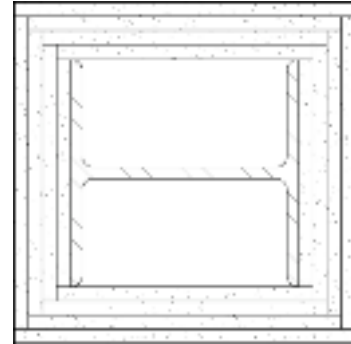

Fire Test: UL NC505-(1-6), 71NK2639, 12-23-75;  
UL NC505, 77NK1518;  
UL Design X526

**GA FILE NO. CM 4322**

**PROPRIETARY\***

**4 HOUR  
FIRE**

**STEEL STUDS, GYPSUM WALLBOARD**

**Base** layer 1/2" proprietary type X gypsum wallboard or gypsum veneer base applied to 1 5/8" steel studs located at each corner of heavy steel W14x228 column with 1" Type S drywall screws 12" o.c. **Face** layer 1/2" proprietary type X gypsum wallboard or gypsum veneer base applied to studs with 1 5/8" Type S drywall screws 12" o.c. Metal cornerbead applied with 4d coated nails, 1 3/8" long, 0.067" shank, 1 3/64" heads, 12" o.c. in each flange.

**PROPRIETARY GYPSUM BOARD**

- |                              |   |   |
|------------------------------|---|---|
| American Gypsum Company LLC  | - | 1/2" FireBloc® Type C                                   |
| CertainTeed Gypsum Inc.      | - | 1/2" ProRoc® Type C Gypsum Panels                       |
| Georgia-Pacific Gypsum LLC   | - | 1/2" ToughRock® Fireguard C™                            |
| Lafarge North America Inc.   | - | 1/2" Firecheck® Type C                                  |
| National Gypsum Company      | - | 1/2" Gold Bond® Brand FIRE-SHIELD C™<br>Gypsum Board    |
| PABCO Gypsum                 | - | 1/2" FLAME CURB® Super 'C'™                             |
| Temple-Inland                | - | 1/2" TG-C   |
| United States Gypsum Company | - | 1/2" SHEETROCK® Brand FIRECODE® C<br>Core Gypsum Panels |

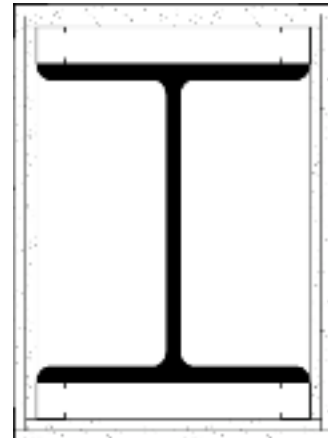

Fire Test: UL R1319-127, 8-20-69;  
Based on UL R3660-7, -8;  
11-12-87; UL R7094,  
90NK10635, 12-4-90;  
UL Design X507

\*Contact the manufacturer for more detailed information on proprietary products.

## COLUMNS, NONCOMBUSTIBLE

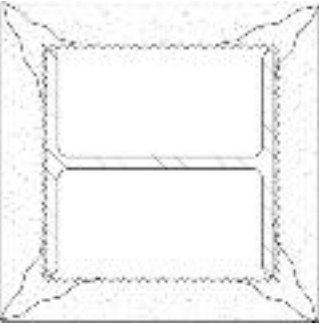
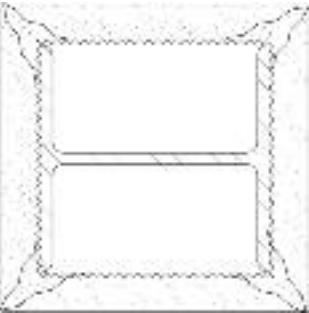
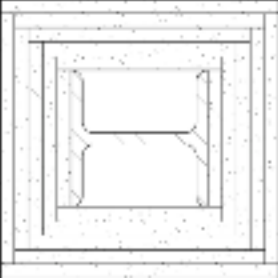
GA FILE NO. CM 4410	GENERIC	4 HOUR FIRE
<p align="center"><b>GYPSUM PLASTER, METAL LATH</b></p> <p>1<sup>3</sup>/<sub>4</sub>" 1:2-1:3 gypsum-perlite plaster applied over 3.4 lb. self-furring expanded diamond mesh metal lath and 2<sup>1</sup>/<sub>4</sub>" wide flanged expanded metal corner beads wire tied to W10x49 column with 18 gage galvanized wire 6" o.c.</p>		 <p>Fire Test: UL R3187-4, -5, -7, 7-30-52, UL Design X402</p>
<p align="center"><b>GYPSUM PLASTER, METAL LATH</b></p> <p>1<sup>1</sup>/<sub>2</sub>" 1:2-1:3 gypsum-perlite plaster applied over 3.4 lb. metal lath wire tied to W10x49 column with 18 gage wire 24" o.c. Lath spaced 7<sup>1</sup>/<sub>16</sub>" away from column with 3<sup>3</sup>/<sub>4</sub>" cold rolled channels.</p>		 <p>Fire Test: UL R3187-6, 8-7-52, UL Design X406</p>
<p align="center"><b>GYPSUM WALLBOARD, STEEL COLUMN COVER</b></p> <p><b>Base</b> layer 5<sup>8</sup>/<sub>8</sub>" type X gypsum wallboard applied around W6x15.5 column and held in place with paper masking tape. <b>Second</b> layer 5<sup>8</sup>/<sub>8</sub>" type X gypsum wallboard applied around column and held in place with paper masking tape. <b>Third</b> layer 5<sup>8</sup>/<sub>8</sub>" type X gypsum wallboard applied around column and held in place with paper masking tape. <b>Fourth</b> layer 5<sup>8</sup>/<sub>8</sub>" type X gypsum wallboard applied around column and held in place with paper masking tape. <b>Fifth</b> layer 5<sup>8</sup>/<sub>8</sub>" type X gypsum wallboard applied around column and held in place with paper masking tape. <b>Face</b> layer either No. 24 MSG stainless steel column cover consisting of two L-shaped sections with snap-lock sheet steel joints or No. 22 MSG stainless steel column covers consisting of two L-shaped sections with lap joints fastened with No. 8x1<sup>1</sup>/<sub>2</sub>" sheet metal screws 12" o.c.</p>		 <p>Fire Test: UL NC505-(1-6), 71NK2639, 12-23-75; UL NC505, 77NK1518; UL Design X526</p>

**BEAMS, GIRDERS, AND TRUSSES, NONCOMBUSTIBLE**

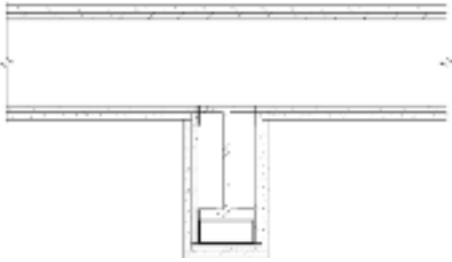
<b>GA FILE NO. BM 1137</b>	<b>PROPRIETARY*</b>	<b>1 HOUR FIRE</b>																									
<b>STEEL FRAME, GYPSUM WALLBOARD</b>																											
<p><b>Base</b> layer 1/2" proprietary type X gypsum wallboard applied to beam cage with 1" Type S-12 drywall screws 12" o.c. <b>Face</b> layer 1/2" proprietary type X gypsum wallboard applied to beam cage with 1 5/8" Type S-12 drywall screws 12" o.c. Joints offset from base layer joints.</p> <p>Beam cage fabricated from No. 24 gage 7/8" x 1 3/8" steel angles screw attached to steel joists at beam top flange and No. 25 gage 2 1/2" steel runners hooked over beam lower flange and supporting 1 5/8" steel studs 24" o.c. Minimum beam size W8x15. <b>(One hour unrestrained beam.)</b></p>																											
<b>PROPRIETARY GYPSUM BOARD</b>																											
<table style="width: 100%; border: none;"> <tr> <td style="width: 30%;">American Gypsum Company LLC</td> <td style="width: 30%;">-</td> <td style="width: 40%;">1/2" FireBloc® Type C</td> </tr> <tr> <td>CertainTeed Gypsum Inc.</td> <td>-</td> <td>1/2" ProRoc® Type C Gypsum Panels</td> </tr> <tr> <td>Georgia-Pacific Gypsum LLC</td> <td>-</td> <td>1/2" ToughRock® Fireguard C™</td> </tr> <tr> <td>Lafarge North America Inc.</td> <td>-</td> <td>1/2" Firecheck® Type C</td> </tr> <tr> <td>National Gypsum Company</td> <td>-</td> <td>1/2" Gold Bond® Brand FIRE-SHIELD C™ Gypsum Board</td> </tr> <tr> <td>PABCO Gypsum</td> <td>-</td> <td>1/2" FLAME CURB® Super 'C'™</td> </tr> <tr> <td>Temple-Inland</td> <td>-</td> <td>1/2" TG-C</td> </tr> <tr> <td>United States Gypsum Company</td> <td>-</td> <td>1/2" SHEETROCK® Brand FIRECODE® C Core Gypsum Panels</td> </tr> </table>		American Gypsum Company LLC	-	1/2" FireBloc® Type C	CertainTeed Gypsum Inc.	-	1/2" ProRoc® Type C Gypsum Panels	Georgia-Pacific Gypsum LLC	-	1/2" ToughRock® Fireguard C™	Lafarge North America Inc.	-	1/2" Firecheck® Type C	National Gypsum Company	-	1/2" Gold Bond® Brand FIRE-SHIELD C™ Gypsum Board	PABCO Gypsum	-	1/2" FLAME CURB® Super 'C'™	Temple-Inland	-	1/2" TG-C	United States Gypsum Company	-	1/2" SHEETROCK® Brand FIRECODE® C Core Gypsum Panels	<p>Fire Test: UL R1319-133, 7-16-75; Based on UL R3660-7 &amp; -8, 11-12-87; UL Design L524</p>	
American Gypsum Company LLC	-	1/2" FireBloc® Type C																									
CertainTeed Gypsum Inc.	-	1/2" ProRoc® Type C Gypsum Panels																									
Georgia-Pacific Gypsum LLC	-	1/2" ToughRock® Fireguard C™																									
Lafarge North America Inc.	-	1/2" Firecheck® Type C																									
National Gypsum Company	-	1/2" Gold Bond® Brand FIRE-SHIELD C™ Gypsum Board																									
PABCO Gypsum	-	1/2" FLAME CURB® Super 'C'™																									
Temple-Inland	-	1/2" TG-C																									
United States Gypsum Company	-	1/2" SHEETROCK® Brand FIRECODE® C Core Gypsum Panels																									

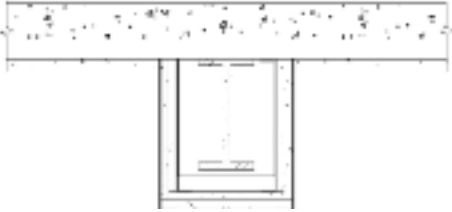
<b>GA FILE NO. BM 2120</b>	<b>GENERIC</b>	<b>2 HOUR FIRE</b>	
<b>STEEL FRAME, GYPSUM WALLBOARD</b>			
<p><b>Base</b> layer 5/8" type X gypsum wallboard or gypsum veneer base applied to beam cage with 1 1/4" Type S drywall screws 16" o.c. <b>Face</b> layer 5/8" type X gypsum wallboard or gypsum veneer base applied to beam cage with 1 3/4" Type S drywall screws 8" o.c.</p> <p>Beam cage fabricated from horizontally installed steel angles (25 gage steel having 1" and 2" legs) located not less than 1/2" from beam flanges. 1" legs of the upper angles secured to steel deck units with 1/2" Type S pan head screws 12" o.c. "U" shaped brackets formed of 25 gage "U" shaped steel channels (1 11/16" wide with 1" legs) 24" o.c. suspended from upper angles with 1/2" Type S pan head screws and supported 1" x 2" angles at lower corners attached to brackets with 1/2" Type S pan head screws. Outside corners of gypsum board protected by 0.020" thick steel corner beads crimped or nailed. Minimum beam size W8x24. <b>(Two hour restrained or unrestrained beam.)</b></p>			
		<p>Fire Test: UL R4024-5, 9-14-66, UL Design N501; ULC Design O501</p>	

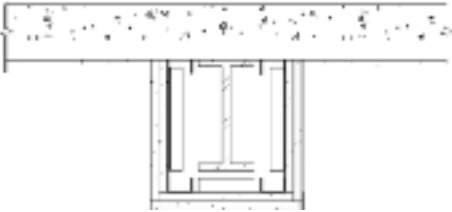
<b>GA FILE NO. BM 2130</b>	<b>GENERIC</b>	<b>2 HOUR FIRE</b>	
<b>STEEL FRAME, GYPSUM WALLBOARD</b>			
<p><b>Base</b> layer 5/8" type X gypsum wallboard or gypsum veneer base applied to beam cage with 1 1/4" Type S drywall screws 16" o.c. <b>Face</b> layer 5/8" type X gypsum wallboard or gypsum veneer base applied to beam cage with 1 3/4" Type S drywall screws 8" o.c.</p> <p>Beam cage fabricated from horizontally installed "U" shaped steel channels (25 gage steel 1 11/16" wide with 1" legs) located not less than 1/2" from beam flanges. Upper channels secured to steel deck units with 1/2" Type S pan head screws 12" o.c. "U" shaped brackets formed of steel channels 24" o.c. suspended from the upper channels with 1/2" Type S pan head screws and supported steel channels installed at lower corners of brackets. Outside corners of gypsum board protected by 0.020" thick steel corner beads crimped or nailed. Minimum beam size W8x24. <b>(Two hour restrained or unrestrained beam.)</b></p>			
		<p>Fire Test: UL R4024-5, 9-14-66; UL Design N502; ULC Design O502</p>	

\*Contact the manufacturer for more detailed information on proprietary products.

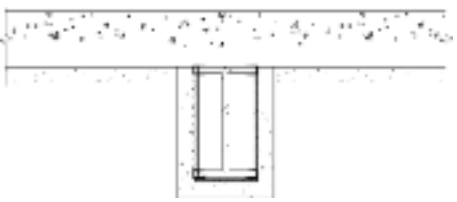
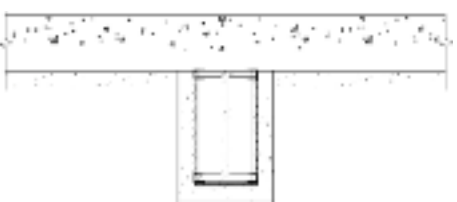
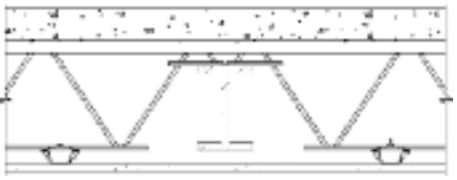
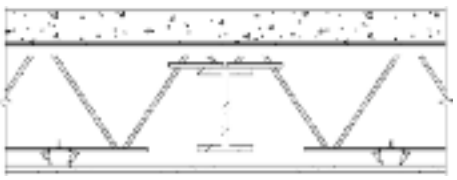
BEAMS, GIRDERS, AND TRUSSES, NONCOMBUSTIBLE			
<b>GA FILE NO. BM 2221</b>	<b>GENERIC</b>	<b>2 HOUR FIRE</b>	
<b>METAL LATH, GYPSUM PLASTER</b>			
<p>11/8" 1:2 mill-mixed gypsum-perlite plaster applied over 3.4 lb. diamond mesh metal lath attached to beam flange with 11 gage steel clips 9" o.c. 1" space between beam bottom flange and lath. Minimum beam size W8x24. <b>(Two hour restrained beam.)</b></p>			<p>Fire Test: UL R4197-1, 1-29-59</p>
<b>GA FILE NO. BM 3110</b>	<b>GENERIC</b>	<b>3 HOUR FIRE</b>	
<b>METAL LATH, GYPSUM PLASTER</b>			
<p>11/4" 1:2 mill-mixed gypsum-perlite plaster applied over 3.4 lb. diamond mesh metal lath attached to beam flange with 11 gage steel clips 9" o.c. Minimum beam size W8x24. <b>(Three hour restrained beam.)</b></p>			<p>Fire Test: UL R4197-1, 1-29-59</p>
<b>GA FILE NO. BM 3212</b>	<b>PROPRIETARY*</b>	<b>3 HOUR FIRE</b>	
<b>CEILING MEMBRANE FIREPROOFING, METAL CHANNELS, GYPSUM WALLBOARD</b>			
<p>One layer 5/8" proprietary type X gypsum wallboard or gypsum veneer base applied at right angles to furring channels 24" o.c. (double channels at end joints) with 1" Type S drywall screws 12" o.c. 5/8" x 23/4" type X gypsum wallboard strips over butt joints. Furring channels wire tied to open web steel joists 24" o.c. supporting 3/8" rib metal lath and 2 1/2" concrete slab. Minimum beam size W8x35. <b>(Three hour unrestrained beam.)</b></p> <p>(See GA File No. FC 3012)</p>			<p>Fire Test: UL R1319-79, 4-14-65 (Rev. 4-4-77); UL R3501, 88NK21023, 11-27-89; Based on UL R3660-7, -8, 11-12-87; UL R2717-61, 8-18-87; UL Design G512</p>
<b>PROPRIETARY GYPSUM BOARD</b>			
<p>American Gypsum Company LLC - 5/8" FireBloc® Type C                  CertainTeed Gypsum Inc. - 5/8" ProRoc® Type C Gypsum Panels                  Georgia-Pacific Gypsum LLC - 5/8" ToughRock® Fireguard C™                  Lafarge North America Inc. - 5/8" Firecheck® Type C                  National Gypsum Company - 5/8" Gold Bond® Brand FIRE-SHIELD C™ Gypsum Board                  PABCO Gypsum - 5/8" FLAME CURB® Super 'C'™                  Temple-Inland - 5/8" TG-C                  United States Gypsum Company - 5/8" SHEETROCK® Brand FIRECODE® C Core Gypsum Panels</p>			
<b>GA FILE NO. BM 3310</b>	<b>GENERIC</b>	<b>3 HOUR FIRE</b>	
<b>CEILING MEMBRANE FIREPROOFING, METAL CHANNELS, GYPSUM WALLBOARD</b>			
<p>One layer 1/2" type X gypsum wallboard or gypsum veneer base applied at right angles to rigid furring channels 24" o.c. with 1" Type S drywall screws 12" o.c. Gypsum board end joints located midway between continuous channels and attached to additional pieces of channel 54" long with screws 12" o.c. Furring channels 24" o.c. attached with 18 gage wire ties 48" o.c. to open web steel joists 24" o.c. supporting 3/8" rib metal lath or 9/16" deep 28 gage corrugated steel and 2 1/2" concrete slab measured from top of flute. Furring channels may be attached to 1 1/2" cold rolled carrying channels 48" o.c. suspended from joists by 8 gage wire hangers not over 48" o.c. Minimum beam size W8x31. <b>(Three hour unrestrained beam.)</b></p> <p>(See GA File No. FC 2030)</p>			<p>Fire Test: UL R3501, 66K3415, 7-22-66, UL Design G514</p>

\*Contact the manufacturer for more detailed information on proprietary products.

**BEAMS, GIRDERS, AND TRUSSES, NONCOMBUSTIBLE**

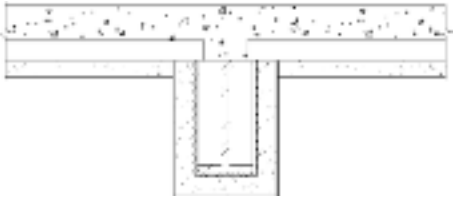
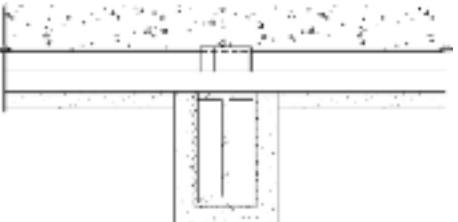
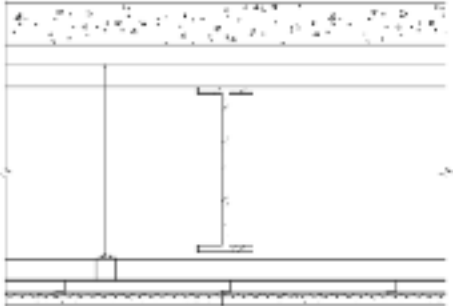
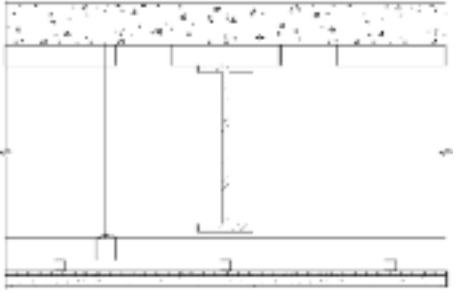
<p><b>GA FILE NO. BM 4310</b></p>	<p><b>GENERIC</b></p>	<p><b>4 HOUR FIRE</b></p>
<p><b>GYPSUM PLASTER, METAL LATH</b></p> <p>1 1/2" 1:2 gypsum-perlite plaster applied over 3.4 lb. self-furring diamond mesh metal lath tied with 18 gage wire 6" o.c. and held 1/4" from steel. Minimum beam size W12x58. <b>(Four hour unrestrained beam.)</b></p>		 <p>Fire Test: UL R3413-4, 7-1-53, UL Design D404</p>
<p><b>GA FILE NO. BM 4320</b></p>	<p><b>GENERIC</b></p>	<p><b>4 HOUR FIRE</b></p>
<p><b>GYPSUM PLASTER, METAL LATH</b></p> <p>1 1/2" 1:2 1/2 gypsum-perlite plaster applied over 3.4 lb. diamond mesh metal lath tied with 18 gage galvanized wire 4" o.c. to floor units and 6" o.c. to No. 6 gage lath hangers 22" to 28" o.c. wrapped completely around beam. Minimum beam size W12x27. <b>(Four hour unrestrained beam.)</b></p>		 <p>Fire Test: UL R3789-1, 10-3-56, UL Design A406</p>
<p><b>GA FILE NO. BM 4410</b></p>	<p><b>GENERIC</b></p>	<p><b>4 HOUR FIRE</b></p>
<p><b>GYPSUM PLASTER, METAL LATH</b></p> <p>3/4" 1:2 mill-mixed gypsum-perlite plaster applied over 3.4 lb. diamond mesh metal lath wire tied to 3/4" cold rolled channels 12" o.c. with 18 gage wire. Channels wire tied with 8 gage wire to 1 1/2" cold rolled carrying channels 48" o.c. suspended from steel deck and 2" concrete slab. 3 1/2" minimum clearance from lower beam flange to top of ceiling. Minimum beam size W12x27. <b>(Four hour unrestrained beam.)</b></p>		 <p>Fire Test: UL R3574-6, 7-25-57, UL Design A403</p>
<p><b>GA FILE NO. BM 4420</b></p>	<p><b>GENERIC</b></p>	<p><b>4 HOUR FIRE</b></p>
<p><b>GYPSUM PLASTER, METAL LATH</b></p> <p>7/8" 1:2-1:3 gypsum-perlite plaster applied over 3.4 lb. diamond mesh metal lath tied to 3/4" cold rolled channels 12" o.c. with 18 gage wire. Channels wire tied to 1 1/2" cold rolled carrying channels 36" o.c. suspended with 8 gage hanger wire 48" o.c. from cellular steel deck and 2" concrete slab. Minimum clearance 3 1/2" from lower beam flange to top of ceiling. Minimum beam size W12x27. <b>(Four hour unrestrained beam.)</b></p>		 <p>Fire Test: UL R3355-1, 4-30-51, UL Design A405</p>



**APPENDIX****COMMONLY USED METRIC CONVERSIONS****Gypsum Board Thickness**

1/4 in. - 6.4 mm

3/8 in. - 9.5 mm

1/2 in. - 12.7 mm

5/8 in. - 15.9 mm

3/4 in. - 19.0 mm

1 in. - 25.4 mm

**Framing Spacing**

16 in. - 406 mm

24 in. - 610 mm

**Fastener Spacing**

2 in. - 51 mm

2 1/2 in. - 64 mm

7 in. - 178 mm

8 in. - 203 mm

12 in. - 305 mm

16 in. - 406 mm

24 in. - 610 mm

**Temperature**

40°F - 5°C

50°F - 10°C

125°F - 52°C

**NOTES**

GYPSUM ASSOCIATION  
6525 Belcrest Road, #480  
Hyattsville, MD 20782  
301-277-8686  
Fax: 301-277-8747  
E-mail: [info@gypsum.org](mailto:info@gypsum.org)  
<http://www.gypsum.org>



AMERICAN GYPSUM COMPANY LLC  
CERTAINTEED GYPSUM, INC.  
CERTAINTEED GYPSUM CANADA, INC.  
CGC INC.

GEORGIA - PACIFIC GYPSUM LLC

LAFARGE NORTH AMERICA INC.

NATIONAL GYPSUM COMPANY

PABCO GYPSUM  
*a division of PABCO building products, LLC*

TEMPLE - INLAND

UNITED STATES GYPSUM COMPANY



## GYPSUM ASSOCIATION

Gypsum Association  
6525 Belcrest Road, Suite 480  
Hyattsville, MD 20782

301-277-8686  
Fax: 301.277.8747  
E-mail: [info@gypsum.org](mailto:info@gypsum.org)  
<http://www.gypsum.org>

